



FEATURES

- High Optical Output
- 810 nm Peak Emission
- Hermetically Sealed Metal TO-46 Package
- Narrow Angle for Long Distance Applications
- High Radiation Tolerance
- Excellent Power Degradation Characteristics
- Fast Response
- MIL-S-19500 Screening Available
- No Internal Coatings

Electro-Optical Characteristics at 25 °C

Parameters	Test Conditions	Min	Typ	Max	Units
Total Power Output, P _o	I _F = 100 mA	1.5	3		mW
Peak Emission Wavelength, λ _P	I _F = 50 mA		810		nm
Spectral Bandwidth at 50 %, Δλ	I _F = 50 mA		50		nm
Half Intensity Beam Angle, θ	I _F = 50 mA		8		Deg
Forward Voltage, V _F	I _F = 100 mA		1.45	1.8	V
Reverse Breakdown Voltage, V _R	I _R = 10 μA	3	4		V
Capacitance, C	V _R = 0 V		150		pF
Rise Time			60		nsec
Fall Time			60		nsec

Absolute Maximum Ratings at 25°C

Parameters	Units
Power Dissipation ¹	180 mW
Continuous Forward Current	100 mA
Peak Forward Current (10 μs, 150 Hz) ²	3 A
Reverse Voltage	3 V
Lead Soldering Temperature (1/16" from case for 10 sec)	240 °C

¹ Derate per Thermal Derating Curve above 25 °C.

² Derate linearly above 25 °C.

Thermal Parameters

Parameters	Units
Storage and Operating Temperature Range	-65 °C to 150 °C
Maximum Junction Temperature	150 °C
Thermal Resistance, R _{THJA} ¹	400 °C/W Typical
Thermal Resistance, R _{THJA} ²	135 °C/W Typical

¹ Heat transfer minimized by measuring in still air with minimum heat conducting through leads.

² Air circulating at a rapid rate to keep case temperature at 25 °C.

Maximum Rated Thermal Derating Curve

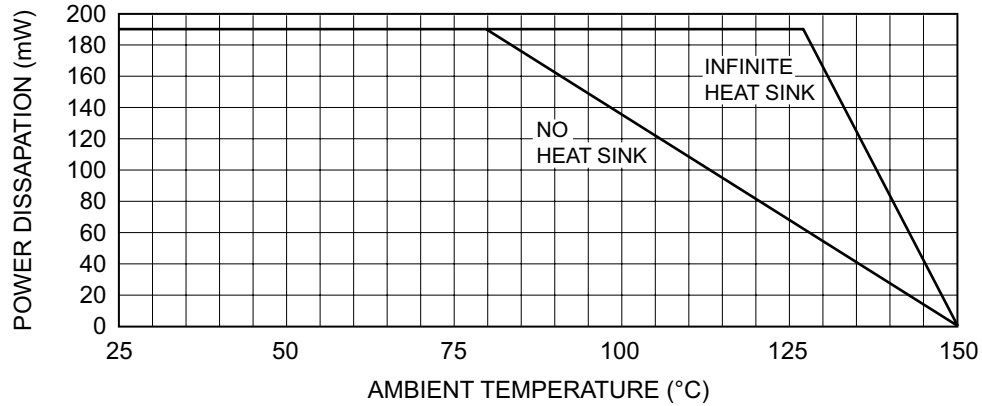

Maximum Peak Pulse Current

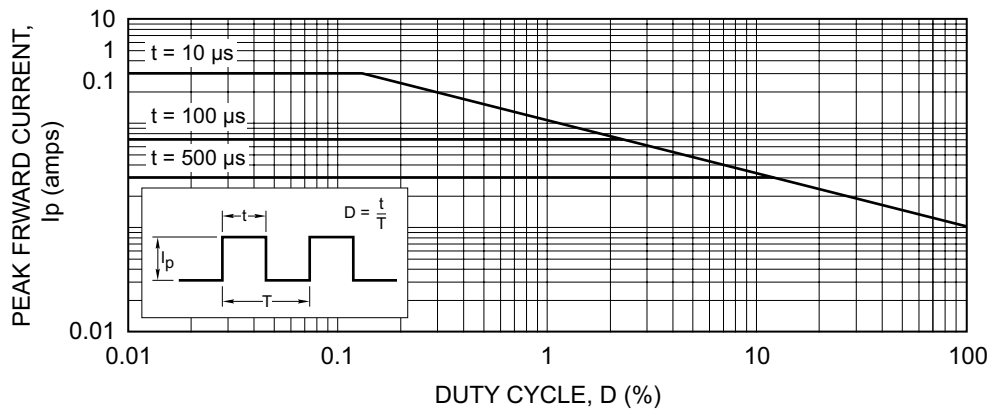

Typical Power Output vs Neutron Irradiation

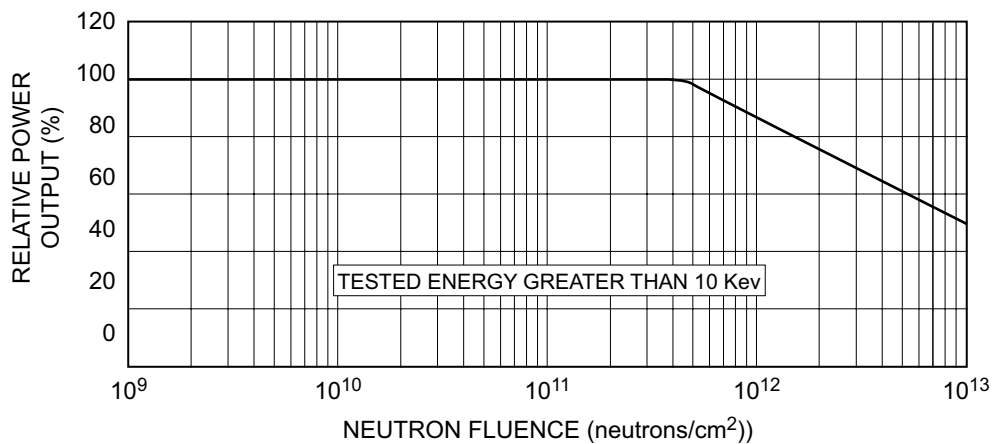

Typical Degradation Curve

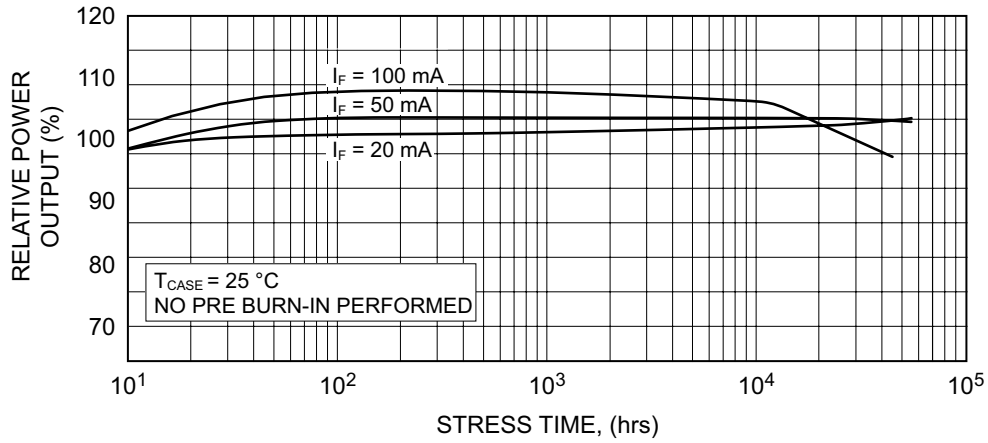

Typical Radiation Pattern

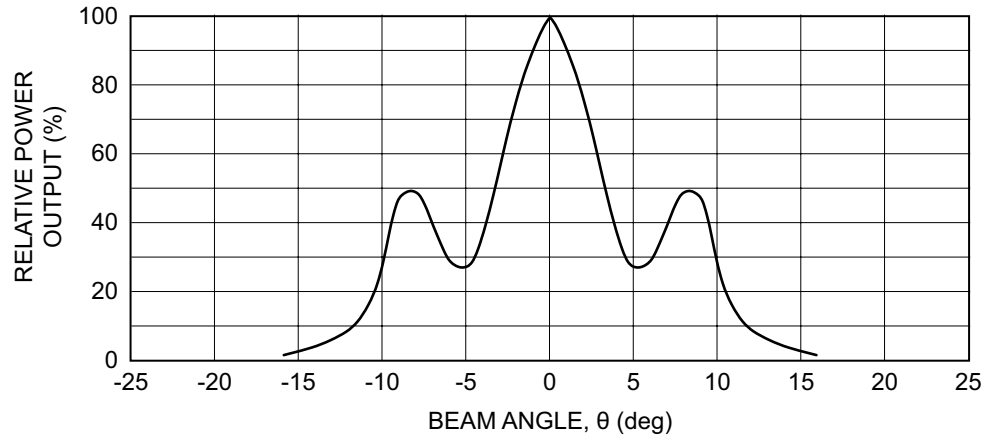

Typical Power Output vs Temperature

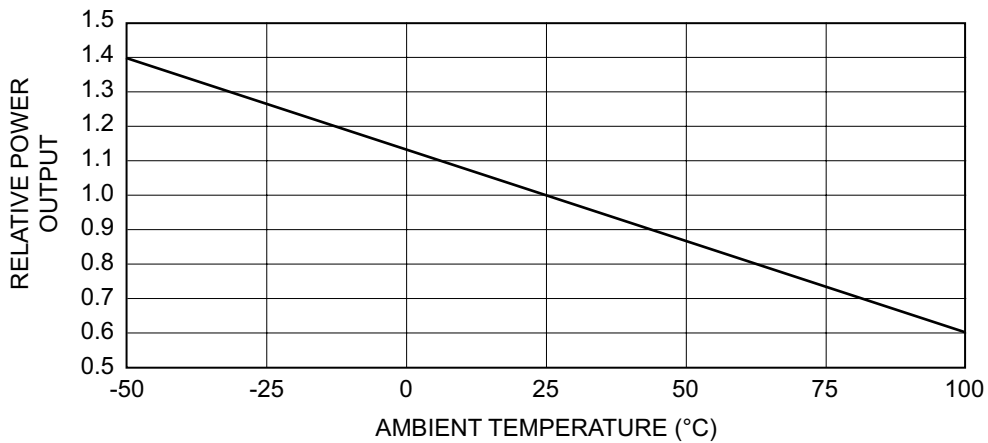

Typical Spectral Output

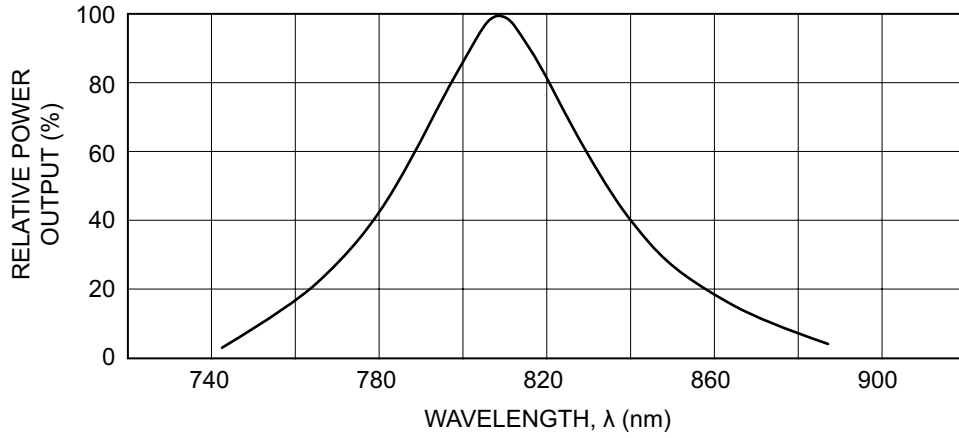

Typical Power Output vs Forward Current

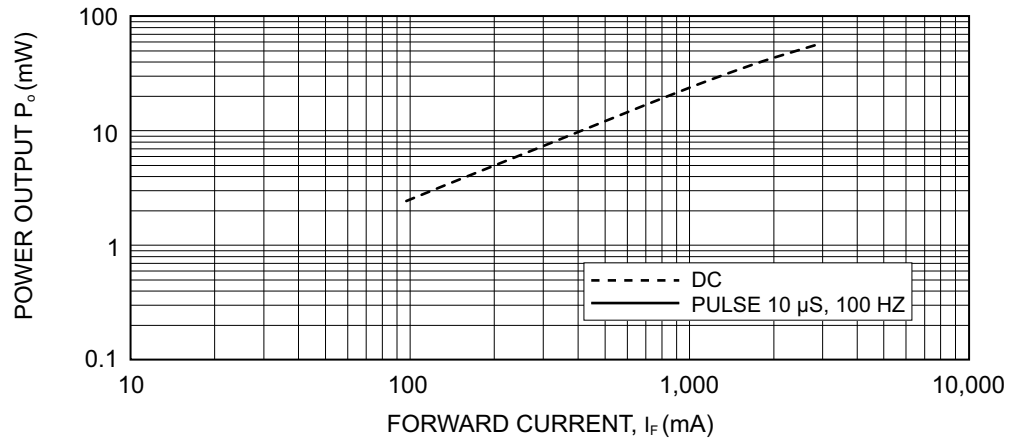

Package Information

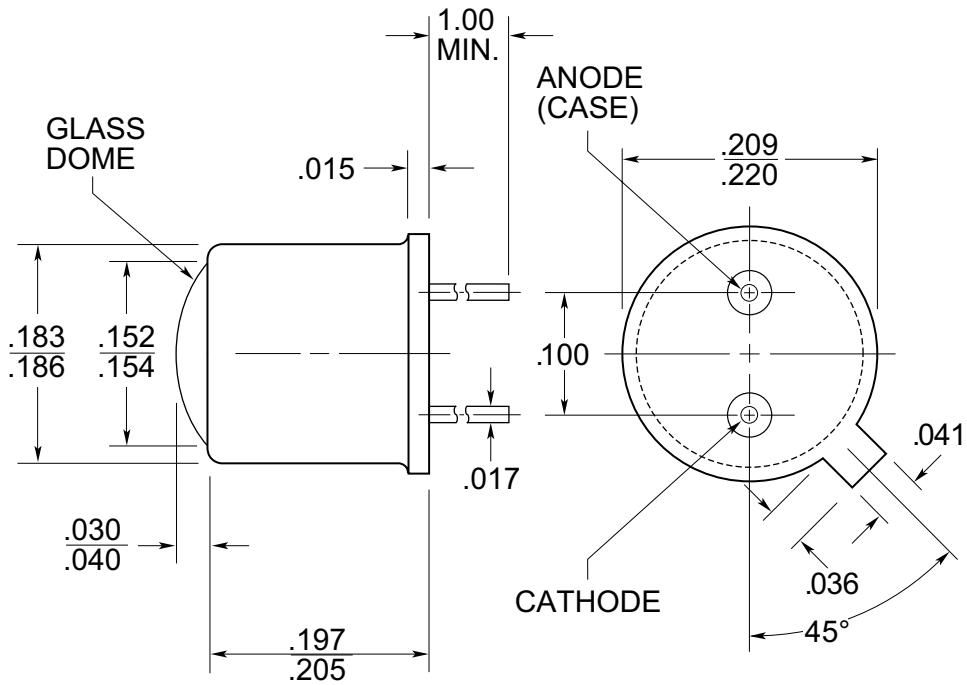

Dimensions are nominal values in inches unless otherwise specified.

Ordering Information

OD-810-005 Hi-Rel Radiation Hardened Narrow Angle IR 810 nm Emitter Shipped in ESD Bag

Specifications are subject to change without prior notice.