



US2AF THRU US2MF

SURFACE MOUNT ULTRA FAST RECTIFIER

Reverse Voltage - 50 to 1000 Volts Forward Current - 2.0 Amperes

SMAF

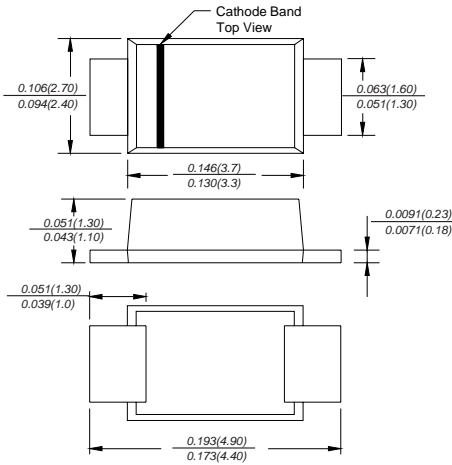

FEATURES

- ◆ The plastic package carries Underwriters Laboratory Flammability Classification 94V-0
- ◆ For surface mounted applications
- ◆ Ultra fast switching for high efficiency
- ◆ Low reverse leakage
- ◆ Built-in strain relief, ideal for automated placement
- ◆ High forward surge current capability
- ◆ High temperature soldering guaranteed 260°C/10 seconds at terminals
- ◆ Glass passivated chip junction

MECHANICAL DATA

Case: JEDEC SMAF molded plastic body over passivated chip
Terminals: Solder plated, solderable per MIL-STD-750, Method 2026

Polarity: Color band denotes cathode end

Mounting Position: Any

Weight: 0.0018 ounce, 0.064 grams

MAXIMUM RATINGS AND ELECTRICAL CHARACTERISTICS

Ratings at 25°C ambient temperature unless otherwise specified.
 Single phase half-wave 60Hz, resistive or inductive load, for capacitive load current derate by 20%.

MDD Catalog Number	SYMBOLS	US2AF	US2BF	US2DF	US2GF	US2JF	US2KF	US2MF	UNITS
Maximum repetitive peak reverse voltage	V_{RRM}	50	100	200	400	600	800	1000	VOLTS
Maximum RMS voltage	V_{RMS}	35	70	140	280	420	560	700	VOLTS
Maximum DC blocking voltage	V_{DC}	50	100	200	400	600	800	1000	VOLTS
Maximum average forward rectified current at $T_L=55^\circ\text{C}$	$I_{(AV)}$	2.0							Amps
Peak forward surge current 8.3ms single half sine-wave superimposed on rated load (JEDEC Method)	I_{FSM}	50.0							Amps
Maximum instantaneous forward voltage at 2.0A	V_F	1.0		1.4		1.7		Volts	
Maximum DC reverse current at rated DC blocking voltage	I_R	$T_A=25^\circ\text{C}$		5.0		$T_A=100^\circ\text{C}$		μA	
Maximum reverse recovery time (NOTE 1)	t_{rr}	50				75		ns	
Typical junction capacitance (NOTE 2)	C_J	20.0							pF
Typical thermal resistance (NOTE 3)	$R_{\theta JA}$	50.0							$^\circ\text{C/W}$
Operating junction and storage temperature range	T_J, T_{STG}	-50 to +150							$^\circ\text{C}$

Note: 1. Reverse recovery condition $I_F=0.5\text{A}, I_R=1.0\text{A}, I_{rr}=0.25\text{A}$
 2. Measured at 1MHz and applied reverse voltage of 4.0V D.C.
 3. P.C.B. mounted with 0.2x0.2" (5.0x5.0mm) copper pad areas



RATINGS AND CHARACTERISTIC CURVES US2AF THRU US2MF

AVERAGE FORWARD RECTIFIED CURRENT, AMPERES

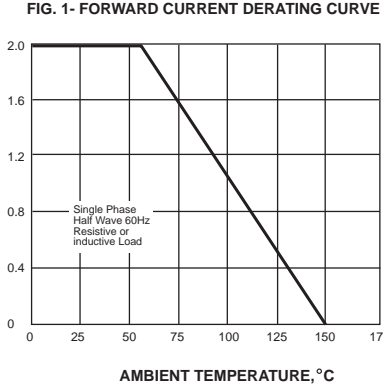

PEAK FORWARD SURGE CURRENT, AMPERES

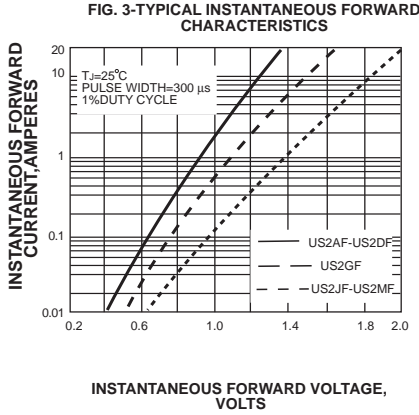
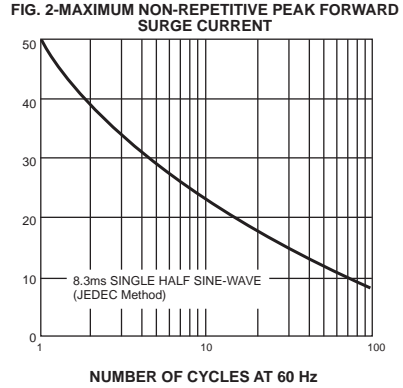

INSTANTANEOUS REVERSE CURRENT, MICROAMPERES

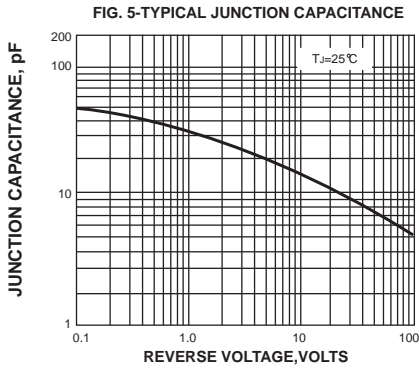
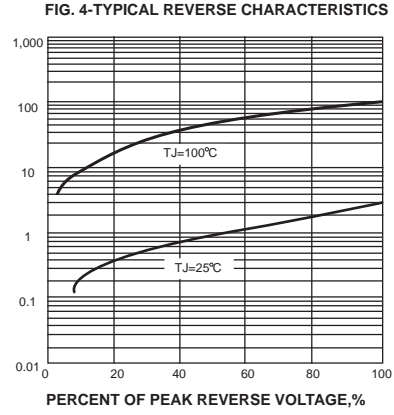

TRANSIENT THERMAL IMPEDANCE, °C/W

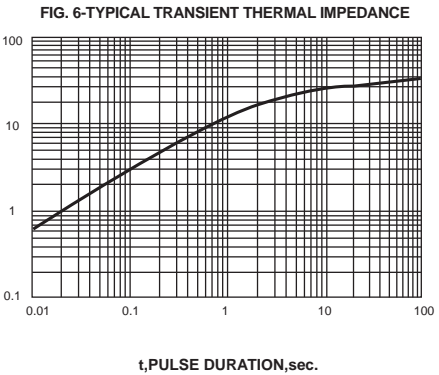

The cruve graph is for reference only, can't be the basis for judgment(曲线图仅供参考!)

