

Electro-Static Discharge for Automobile AUSD24FB Low Capacitance TVS Diode

SOD-323

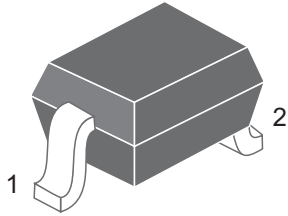

Pin Configuration

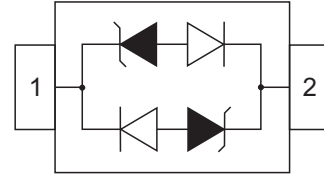

Features

- 350 Watts Peak Pulse Power per Line ($t_p=8/20\mu s$)
- Protects one I/O or power line (bidirectional)
- Low clamping voltage
- Working voltages: 24V
- Low leakage current
- AEC-Q101

IEC Compatibility

- IEC61000-4-2 (ESD) $\pm 30kV$ (air), $\pm 25kV$ (contact)
- IEC61000-4-4 (EFT) 40A (5/50ns)

Applications

- Cell Phone Handsets and Accessories
- Microprocessor based equipment
- Personal Digital Assistants(PDA's)
- Notebooks,Desktops,and Servers
- Portable Instrumentation
- Peripherals
- USB Interface

Mechanical Characteristics

- JEDEC SOD-323 Package
- Molding Compound Flammability Rating:UL 94V-O
- Weight 5 Milligrams(Approximate)
- Quantity Per Reel:3000pcs
- Reel Size:7 inch
- Lead Finish:Lead Free

Maximum Ratings($T_A=25^{\circ}\text{C}$ unless otherwise noted)

Parameter	Symbol	Value	Units
Peak Pulse Power($t_p=8/20\mu\text{s}$)	P_{PP}	350	Watts
Lead Soldering Temperature	T_L	260(10 sec.)	$^{\circ}\text{C}$
Operating Temperature Range	T_J	-55~150	$^{\circ}\text{C}$
Storage Temperature Range	T_{STG}	-55~150	$^{\circ}\text{C}$

Electrical Characteristics($T_A=25^{\circ}\text{C}$ unless otherwise specified)

AUSD24FB(Marking:HC)

Parameter	Symbol	Conditions	Min.	Max.	Units
Reverse Stand-off Voltage	V_{RWM}			24	V
Breakdown Voltage	V_{BR}	$I_T=1\text{mA}$	26.7		V
Clamping Voltage	V_C	$I_{PP}=1\text{A}, t_p=8/20\mu\text{s}$		43	V
		$I_{PP}=3\text{A}, t_p=8/20\mu\text{s}$		56	V
Reverse Leakage Current	I_R	@ V_{RWM}		1	μA
Junction Capacitance	$C_{I/O}$	0Vdc, $f=1\text{MHz}$ Between I/O Pins and GND		1.5	pF

Ratings and Characteristic Curves

Fig.1 Pulse Waveform

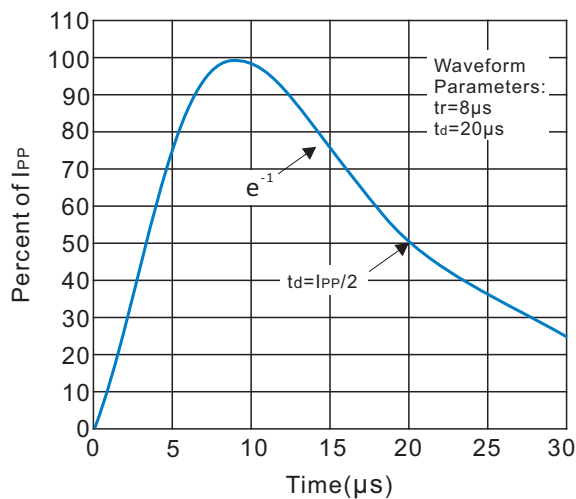
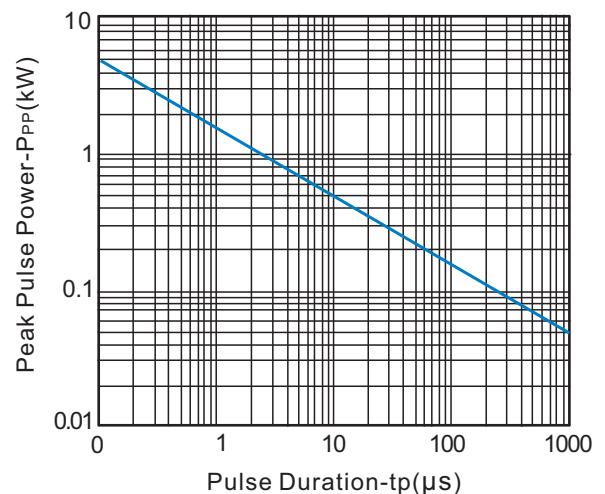
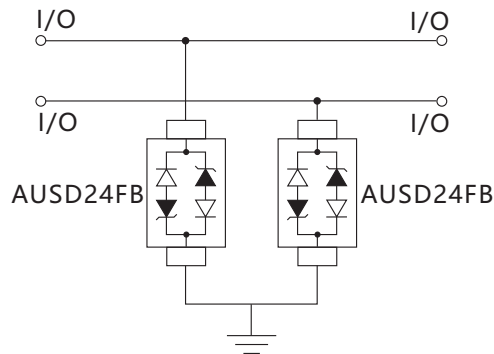

Fig.2 Non-Repetitive Pulse Power vs.Pulse Time



Application Information

I/O Protection



PCB Layout Recommendations

The location and circuit board layout is critical to maximize the effectiveness of the I/O protection circuit. The following guidelines are recommended:

- Locate the protection devices as close as possible to the I/O connector. This allows the protection devices to absorb the energy of the transient voltage before it can be coupled into the adjacent traces on the PCB.
- Minimize the loop area for the high-speed data lines, power and ground lines to reduce the radiated emissions.
- Avoid running protection conductors in parallel with unprotected conductors
- Use ground planes wherever possible to reduce the parasitic capacitance and inductance of the PCB that degrades the effectiveness of a filter device.
- Using shared transient return paths to a common ground point.

Dimensions(SOD-323)

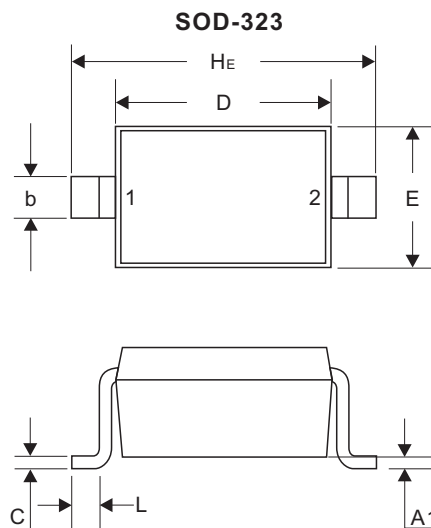

DIM	Millimeters		Inches	
	Min	Max	Min	Max
A	0.80	1.00	0.031	0.040
A1	0.00	0.10	0.000	0.004
A3	0.15REF		0.006REF	
b	0.25	0.40	0.010	0.016
C	0.089	0.177	0.003	0.007
D	1.60	1.80	0.062	0.070
E	1.15	1.35	0.045	0.053
L	0.08		0.003	
HE	2.30	2.70	0.090	0.105

Recommended Mounting Pad Layout

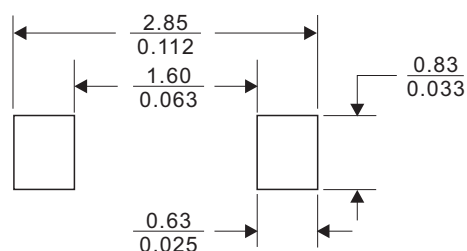

Dimensions in ($\frac{\text{millimeters}}{\text{inches}}$)