

### 1. PART NO. EXPRESSION :

HWI 252018 - 2R2 KF - □□  
 (a) (b) (c) (d)(e) (f)

(a) Series code

(b) Dimension code

(c) Inductance code : 2R2 = 2.2uH

(d) Tolerance code : J = ±5%, K = ±10%, M = ±20%

(e) F : RoHS Compliant

(f) 11 ~ 99 : Internal controlled number

### 2. CONFIGURATION & DIMENSIONS :

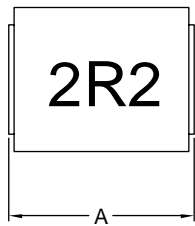

Weight: 25mg

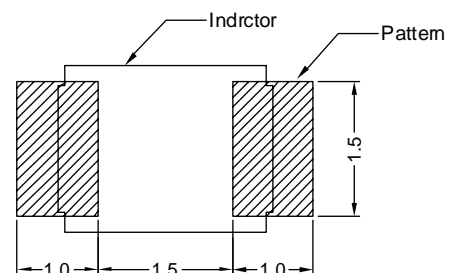
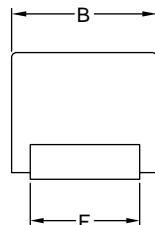
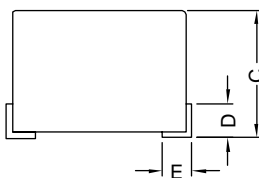

Unit:m/m

A	B	C	D	E	F
2.5±0.3	2.0±0.2	1.8±0.2	0.4	0.4±0.2	1.4±0.1

INDUCTOR PATTERN

### 3. SCHEMATIC :

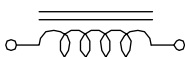

### 4. MATERIALS :

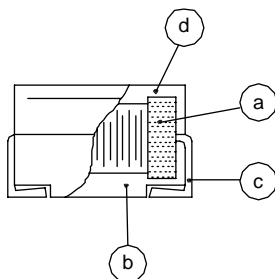

(a) Core : DR Ferrite Core

(b) Wire : Enamelled Copper Wire

(c) Terminal : Tinned Copper Flat

(d) Capsulate : Epoxy Novolac Molding Compound



RoHS Compliant

NOTE : Specifications subject to change without notice. Please check our website for latest information.

30.10.2012



SUPERWORLD ELECTRONICS (S) PTE LTD

PG. 1

### 5. GENERAL SPECIFICATION :

- a) Temp. rise : 20° C Max.
- b) Ambient temp. : 100° C Max.
- c) Storage temp. : -40° C to +125° C
- d) Operating temp. : -40° C to +125° C
- e) Terminal strength : 0.5Kg Min.
- f) Rated current : Current cause inductance drop within 10%
- g) Resistance to solder heat : 260° C for 10secs
- h) Resistance to solvent : Per MIL-STD-202F

### 6. RECOMMENDED REFLOW SOLDERING PROFILE :

6-1: Reflow soldering

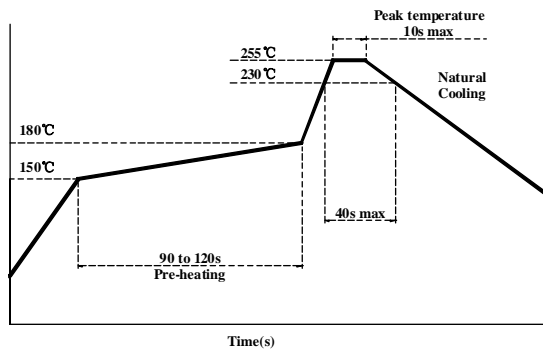

6-2: Flow soldering

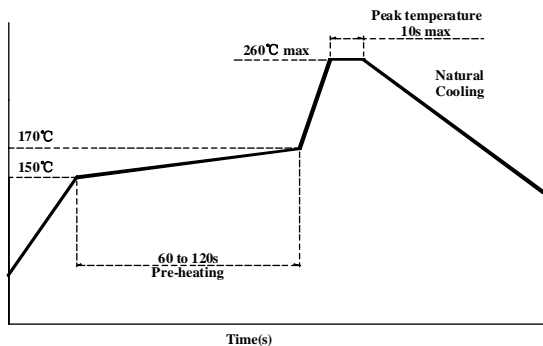

Tip temperature	300~350° C
Heating time	3 sec/soldering
Soldering rod specifications	Output: 30W Tip diameter: 1mm



**RoHS Compliant**

NOTE : Specifications subject to change without notice. Please check our website for latest information.

30.10.2012



**SUPERWORLD ELECTRONICS (S) PTE LTD**

# MOLDED WIREWOUND CHIP INDUCTORS

HWI252018 SERIES

## 7. ELECTRICAL CHARACTERISTICS :

Part No.	Inductance ( $\mu$ H)	Q Min.	Test Frequency ( MHz )	SRF ( MHz ) Min.	RDC ( $\Omega$ ) Max.	IDC ( mA ) Max.
HWI252018-1R0 $\square$ F	1.00	20	7.96	200	0.34	475
HWI252018-1R5 $\square$ F	1.50	20	7.96	165	0.42	435
HWI252018-2R2 $\square$ F	2.20	20	7.96	75	0.50	390
HWI252018-3R3 $\square$ F	3.30	20	7.96	55	0.85	340
HWI252018-4R7 $\square$ F	4.70	20	7.96	43	1.04	285
HWI252018-6R8 $\square$ F	6.80	20	7.96	39	1.25	275
HWI252018-100 $\square$ F	10.00	20	2.52	30	1.69	210
HWI252018-150 $\square$ F	15.00	25	2.52	21	2.40	175
HWI252018-220 $\square$ F	22.00	25	2.52	18	3.00	160
HWI252018-330 $\square$ F	33.00	25	2.52	16	5.50	120

Inductance tolerance : J :  $\pm$  5%

K :  $\pm$  10%

M :  $\pm$  20%

NOTE : Specifications subject to change without notice. Please check our website for latest information.

30.10.2012



SUPERWORLD ELECTRONICS (S) PTE LTD

PG. 3

### 8. PACKAGING INFORMATION :

#### ( 1 ) Reel Specifications

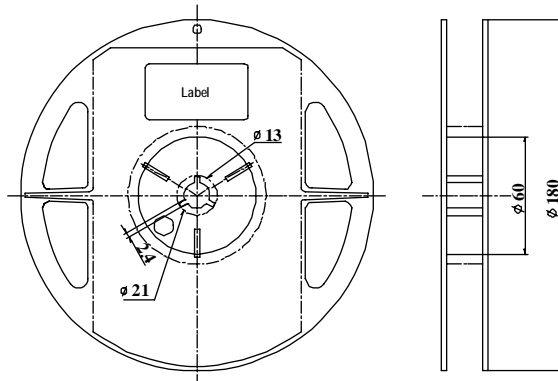

	Type	Size(mm)	Q'ty
1	7" Plastic reel	Ø180*11	2000 pcs
2	Box	185*195*35	2 Reels
3	Box	185*195*60	4 Reels
4	Box	185*195*80	5 Reels
5	Box	185*195*155	10 Reels

#### ( 2 ) Taping specifications

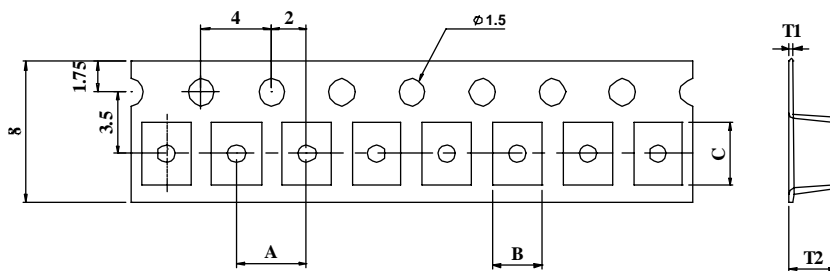

Product	Products thickness (mm)	A(mm)	B(mm)	C(mm)	T1(mm)	T2(mm)	QTY
HWI252018	2.2±0.2	4.0	2.3	2.7	0.3	2.1	2000pcs/reel

#### ( 2 ) Terminal part and leader part tape

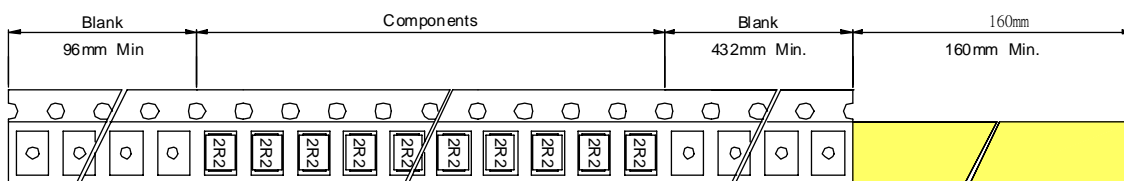

Drawing direction →



**RoHS Compliant**

NOTE : Specifications subject to change without notice. Please check our website for latest information.

30.10.2012



**SUPERWORLD ELECTRONICS (S) PTE LTD**

### 9. RELIABILITY TEST :

TEST ITEM	SPECIFICATION	TEST CONDITION / TEST METHOD
● ELECTRICAL PERFORMANCE TEST		
INDUCTANCE L	REFER TO STANDARD ELECTRICAL CHARACTERISTIC LIST	Q-METER : HP4342A, HP4194A, HPE4991A
Q		IMPEDANCE ANALYZER : HP4194A, HPE4991A
SELF RESONANCE FREQUENCY SRF		WHEATSTONE BRIDGE : YEW-2755 DIGITAL MULTIMETER : 502BC
DC RESISTANCE RDC		APPLIED THE CURRENT TO COILS, THE INDUCTANCE CHANGE SHALL BE LESS THAN 10% TO INITIAL VALUE & TEMPERATURE RISE SHALL NOT BE MORE THAN 20° C
RATED CURRENT IDC		
TEMPERATURE RISE TEST	20° C MAX	1. APPLIED THE ALLOWED DC CURRENT FOR 10 MINUTES 2. TEMPERATURE MEASURE BY DIGITAL SURFACE THERMOMETER
OVER LOAD TEST	AFTER TEST, INDUCTORS SHALL BE NO EVIDENCE OF ELECTRICAL AND MECHANICAL DAMAGE	APPLIED 2 TIMES OF RATED ALLOWED DC CURRENT TO INDUCTOR FOR A PERIOD OF 5 MINUTES
WITHSTANDING VOLTAGE TEST	AFTER TEST, INDUCTORS SHALL BE NO EVIDENCE OF ELECTRICAL AND MECHANICAL DAMAGE	AC VOLTAGE OF 1000VAC APPLIED BETWEEN INDUCTORS TERMINAL AND CASE FOR 1 MINUTE
INSULATION RESISTANCE TEST	1000 MOHM MIN.	100 VDC APPLIED BETWEEN INDUCTOR TERMINAL AND CASE
● MECHANICAL PERFORMANCE TEST		
VIBRATION TEST ( LOW FREQUENCY )	1. INDUCTORS SHALL BE NO EVIDENCE OF ELECTRICAL AND MECHANICAL DAMAGE	1. AMPLITUDE :1.5 m/m 2. FREQUENCY :10 -- 55 -- 10 HZ / 1MIN 3. DIRECTION :X, Y, Z 4. DURATION :2 HRS /X, Y, Z
SHOCK TEST	2. INDUCTANCE SHALL NOT CHANGE MORE THAN ±5%	INDUCTORS SHALL BE DROPPED 10 TIMES FROM A HEIGHT OF 1m ONTO 3cm WOODEN BOARD
RESISTANCE TO SOLDERING HEAT	3. Q SHALL NOT CHANGE MORE THAN ±20%	TEMP :260±5° C TIME :10± 1.0 SEC



**RoHS Compliant**

NOTE : Specifications subject to change without notice. Please check our website for latest information.

30.10.2012



**SUPERWORLD ELECTRONICS (S) PTE LTD**

### 9. RELIABILITY TEST :

TERMINAL STRENGTH-PULL TEST	TERMINAL SHALL NOT BE LOOSENED OR RUPTURED	A 1KG LOAD SHALL BE APPLIED TO BOTH TERMINALS IN THE AXIS DIRECTION FOR 1 MINUTE. ( 0.5KG FOR WI252018 SERIES )
SOLDERABILITY TEST	THE TERMINAL SHALL BE AT LEAST 90% COVERED WITH SOLDER	AFTER FLUXING, INDUCTOR SHALL BE DIPPED IN A MELTED SOLDER BATH AT $240 \pm 5^\circ \text{C}$ FOR 5 SECONDS.
RESISTANCE TO SOLVENT TEST	THERE SHALL BE NO CASE DEFORMATION CHANGE IN APPEARANCE OR OBLITERATION OF MARKING	MIL-STD-202F, METHOD 215D
● CLIMATIC TEST		
TEMPERATURE CHARACTERISTIC	1. INDUCTORS SHALL BE NO EVIDENCE OF ELECTRICAL AND MECHANICAL DAMAGE  2. INDUCTANCE SHALL NOT CHANGE MORE THAN $\pm 10\%$  3. Q SHALL NOT CHANGE MORE THAN $\pm 20\%$	$-40^\circ \text{C}$ ----- $+125^\circ \text{C}$
HUMIDITY TEST		1. TEMP : $40 \pm 2^\circ \text{C}$ 2. R.H. : 90 ----- 95% 3. TIME : $96 \pm 2$ HOURS
COLD TEST		1. TEMP : $-25 \pm 2^\circ \text{C}$ 2. TIME : $96 \pm 2$ HOURS
THERMAL SHOCK TEST		<p style="text-align: center;">TOTAL : 5 CYCLES</p>
DRY HEAT TEST		1. TEMP : $85 \pm 2^\circ \text{C}$ 2. TIME : $96 \pm 2$ HOURS
HIGH TEMPERATURE LOAD LIFE TEST	THERE SHALL BE NO EVIDENCE OF SHORT OR OPEN CIRCUITING	1. TEMP : $85 \pm 2^\circ \text{C}$ 2. TIME : $1000 \pm 12$ HOURS 3. LOAD : ALLOWED DC CURRENT
HUMIDITY LOAD LIFE		1. TEMP : $40 \pm 2^\circ \text{C}$ 2. R.H. : 90 ----- 95% 3. TIME : $1000 \pm 12$ HOURS 4. LOAD : ALLOWED DC CURRENT

● **Note :**

Unless otherwise specified, allow the specimen to stand at room temperature for 1 hour or more but more than 2 hours, measure the electrical and mechanical performances



**RoHS Compliant**

NOTE : Specifications subject to change without notice. Please check our website for latest information.

30.10.2012



**SUPERWORLD ELECTRONICS (S) PTE LTD**

**10. UL CARD**

OBMW2 August 27, 1999  
 Magnet Wire-Component  
 ELEKTRISOLA (MALAYSIA) SDN BHD E143312  
 IALAN DAMN SATU IANDA BAIK 28750 BENTONG, PAHANG  
 DARUL MAKMUR MALAYSIA

Mtl Dsg	Mark Dsg	Coating Type		ANSI Typ	Temp Class
		BC	OC		
Estersol 160	E180	Polyesterimide (solderable)	----	MW-77	180
Amldester 200	A200	Polyesterimide	----	MW-74	200
Polysol-N 155	PN155	Polyurethane	Nylon	MW-80, MW-28	155, 100
Polysol 155	P155	Polyurethane	----	MW-79, MW-79	155, 130
Polysol 155g	Pg155	Polyurethane	----	MW-79	130
Polysol 155p	Pp155,Gp155	Polyurethane	----	MW-79	155
Polysol 160	P160	Polyurethane	----	MW-79	155
Polysol 180	P180	Polyurethane	----	MW-79	155
Polysol 170	P170 or G170	Polyurethane	----	MW-79	156
Polysol-N 180	PN180	Polyurethane	Nylon	----	180

Marking: Company name/material designation or marked designation and factory identification on package ok reel

See General Information preceding These Recognitions  
 For use only in equipment where the acceptability of the combination is determined by Underwriters Laboratories Inc.

OMFZ2 March 4, 1994  
**Component-Plastics**  
 CHANG CHUN PLASTICS CO LTD E59481 (S)  
**( F1-cont. from F card )**

BM-21	ALL	0.79	94HB	50	50	50	—	—	—	—	—
BM-22	ALL	0.79	94HB	50	50	50	—	—	—	—	—
BM-23	ALL	0.79	94V-0	50	50	50	—	—	—	—	—
EME-1100	BK	0.84	94V-0	130	130	130	—	—	—	—	—
	BK	6.4	94V-0	130	130	130	—	—	—	—	—
EME-1200	BK	0.84	94V-0	130	130	130	—	—	—	—	—
	BK	6.4	94V-0	130	130	130	—	—	—	—	—
EME-5961C	BK	0.3	94V-0	130	130	130	—	—	—	—	—
	BK	3.1	94V-0	130	130	130	—	—	—	—	—

Reports: January 19, 1988; January 19, 1988; January 19, 1988; June 2, 1988; June 2, 1998; June 2, 1988.

**Replaces E59481C dated February 7, 1989.** **(Cont. on C1 card)**  
**262854001 N7047 Underwriters Laboratories Inc.®** **D11/0018965**



**RoHS Compliant**

NOTE : Specifications subject to change without notice. Please check our website for latest information.

30.10.2012