

M52749FP

BUS CONTROLLED 3CH VIDEO PRE-AMP FOR CRT DISPLAY MONITOR

DISCRIPTION

M52749FP is Semiconductor Integrated Circuit for CRT Display Monitor. It includes OSD Blanking, OSD Mixing, Retrace Blanking, Wide Band Amplifier, Brightness Control. Main/Sub Contrast and OSD Adjust Function .

FEATURES

- Frequency Band Width: RGB 180MHz(3Vp-p at -3dB)
OSD 80MHz
- Input : RGB 0.7Vp-p(Typ)
OSD 3Vp-p minimum(positive)
BLK(for OSD) 3Vp-p minimum(positive)
Retrace BLK 3Vp-p minimum(positive)
- Output : RGB 5.5Vp-p(maximum)
OSD 3.5Vp-p(maximum)
- Main Contrast , Sub Contrast , OSD Adjust and 5ch D/A OUT can be controlled by I2C Bus.

PIN CONFIGURATION

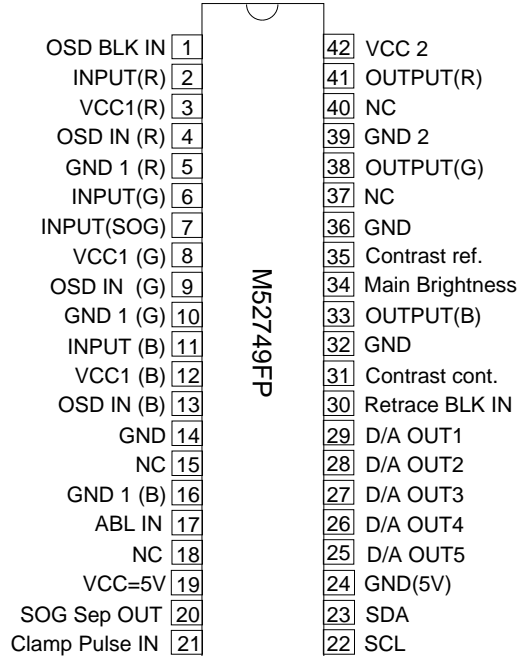

Package:42P9R

STRUCTURE

Bipolar Silicon Monolithic IC

APPLICATION

CRT Display Monitor

RECOMMENDED OPERATING CONDITIONS

Supply Voltage Range	11.5V~12.5V(V3,V8,V12,V42) 4.5V~5.5V(V19)
Rated Supply Voltage	12.0V(V3,V8,V12,V42) 5.0V(V19)

MAJOR SPECIFICATION

Bus Controlled 3ch Video Pre-Amp with OSD Mixing Function and Retrace Blanking Function

M52749FP

BUS CONTROLLED 3CH VIDEO PRE-AMP FOR CRT DISPLAY MONITOR

Fig. 1 Block Diagram

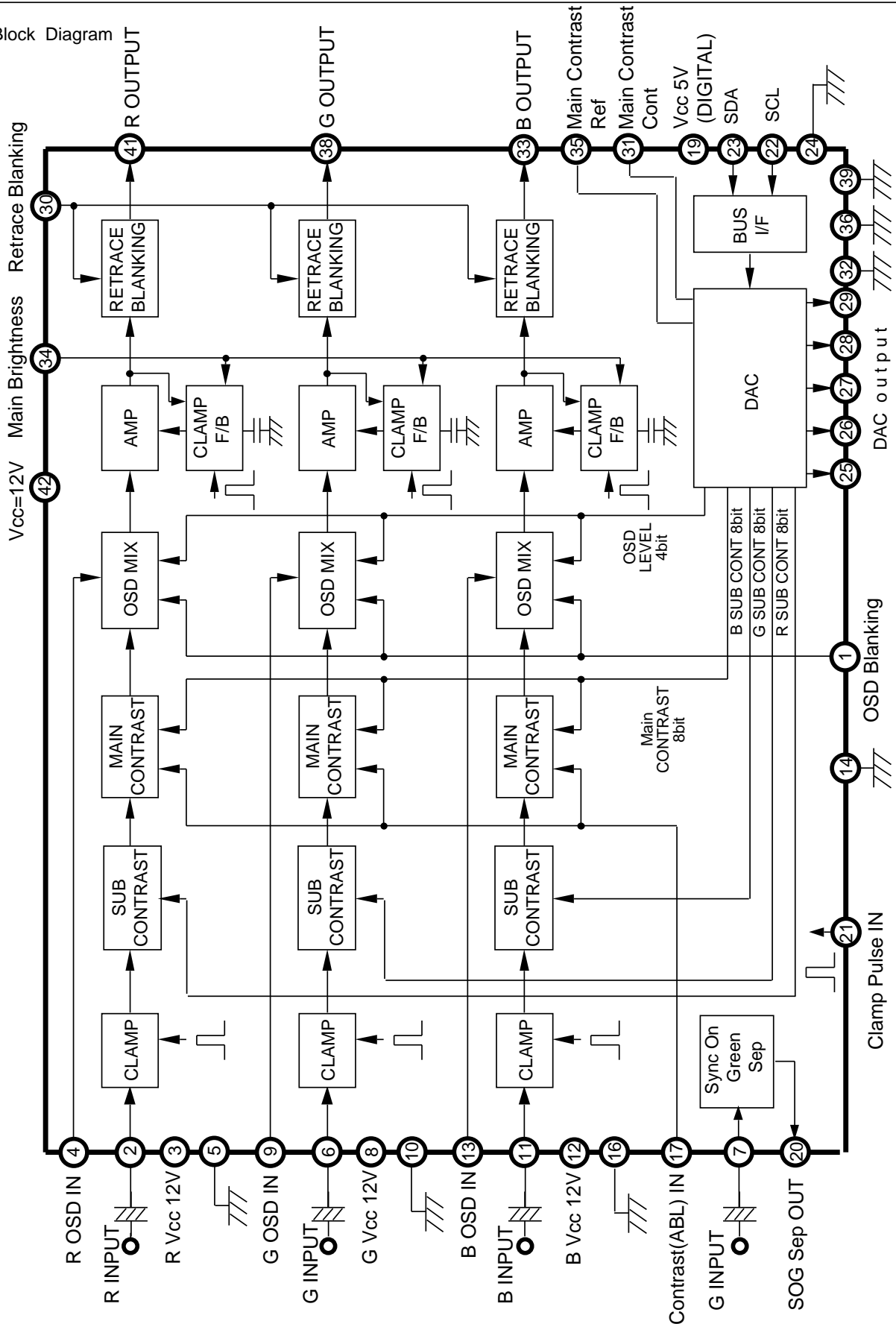

Absolute Maximum Rating (Ambient temperature: 25 °C)

Parameter	Symbol	Rating	Unit
Supply voltage(PIN3,8,12,42)	Vcc 12	13.0	V
Supply voltage(PIN19)	Vcc 5	6.0	V
Power dissipation	Pd	2900	mW
Ambient temperature	Topr	-20~+75	°C
Storage temperature	Tstg	-40~+150	°C
Recommended supply12	Vopr12	12.0	V
Recommended supply5	Vopr5	5.0	V
voltage range12	Vopr'12	11.5~12.5 (TYP 12.0)	V
voltage range5	Vopr'5	4.5~5.5 (TYP 5.0)	V

Thermal Derating Curve

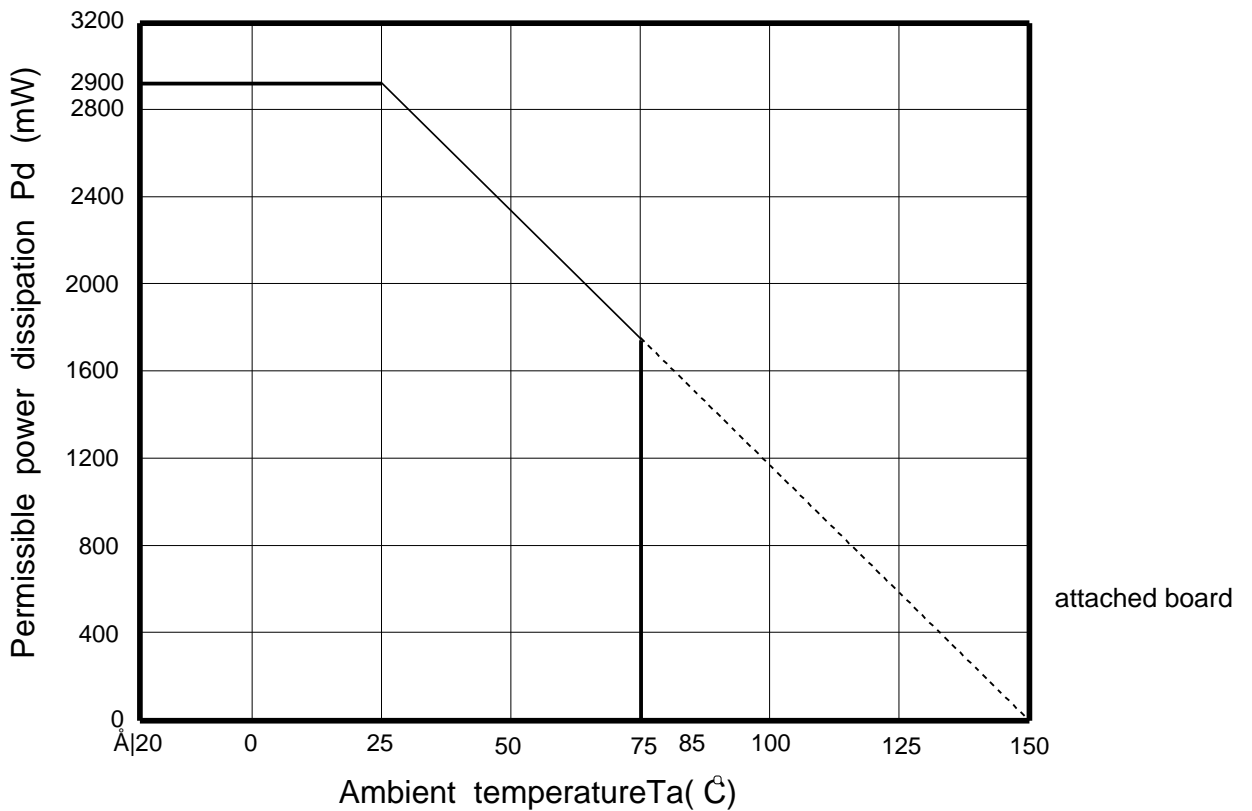

BUS CONTROL TABLE

(1) Slave address:

D7	D6	D5	D4	D3	D2	D1	R/W	
1	0	0	0	1	0	0	0	=88H

(2) Each function's sub address:

NO.	function	bit	sub add.	Data Byte(up:bit information down:preset)							
				D7	D6	D5	D4	D3	D2	D1	D0
1	Main contrast	8	00H	A07	A06	A05	A04	A03	A02	A01	A00
				0	1	0	0	0	0	0	0
2	Sub contrast R	8	01H	A17	A16	A15	A14	A13	A12	A11	A10
				1	0	0	0	0	0	0	0
3	Sub contrast G	8	02H	A27	A26	A25	A24	A23	A22	A21	A20
				1	0	0	0	0	0	0	0
4	Sub contrast B	8	03H	A37	A36	A35	A34	A33	A32	A31	A30
				1	0	0	0	0	0	0	0
5	OSD level	4	04H	-	-	-	-	A43	A42	A41	A40
				0	0	0	0	1	0	0	0
6	D/A OUT1	8	06H	A67	A66	A65	A64	A63	A62	A61	A60
				1	0	0	0	0	0	0	0
7	D/A OUT2	8	07H	A77	A76	A75	A74	A73	A72	A71	A70
				1	0	0	0	0	0	0	0
8	D/A OUT3	8	08H	A87	A86	A85	A84	A83	A82	A81	A80
				1	0	0	0	0	0	0	0
9	D/A OUT4	8	09H	A97	A96	A95	A94	A93	A92	A91	A90
				1	0	0	0	0	0	0	0
10	D/A OUT5	8	0AH	AA7	AA6	AA5	AA4	AA3	AA2	AA1	AA0
				1	0	0	0	0	0	0	0

I²C BUS CONTROL SECTION

SDA,SCL CHARACTERISTICS

parameter	symbol	MIN	MAX	unit
min. input LOW voltage.	V _{IL}	-0.5	1.5	V
max. input HIGH voltage.	V _{IH}	3.0	5.5	V
SCL clock frequency.	f _{SCL}	0	400	KHz
Time the bus must be free before a new transmission can start.	t _{BUF}	1.3	-	us
Hold time start condition.After this period the first clock pulse is generated.	t _{HD:STA}	0.6	-	us
The LOW period of the clock.	t _{LOW}	1.3	-	us
The HIGH period of the clock.	t _{HIGH}	0.6	-	us
Set up time for start condition. (Only relevant for a repeated start condition.)	t _{SU:STA}	0.6	-	us
Hold time DATA.	t _{HD:DAT}	0.1	-	us
Set-up time DATA.	t _{SU:DAT}	100	-	ns
Rise time of both SDA and SCL lines.	t _R	-	300	ns
Fall time of both SDA and SCL lines.	t _F	-	300	ns
Set-up time for stop condition.	t _{SU:STO}	0.6	-	us

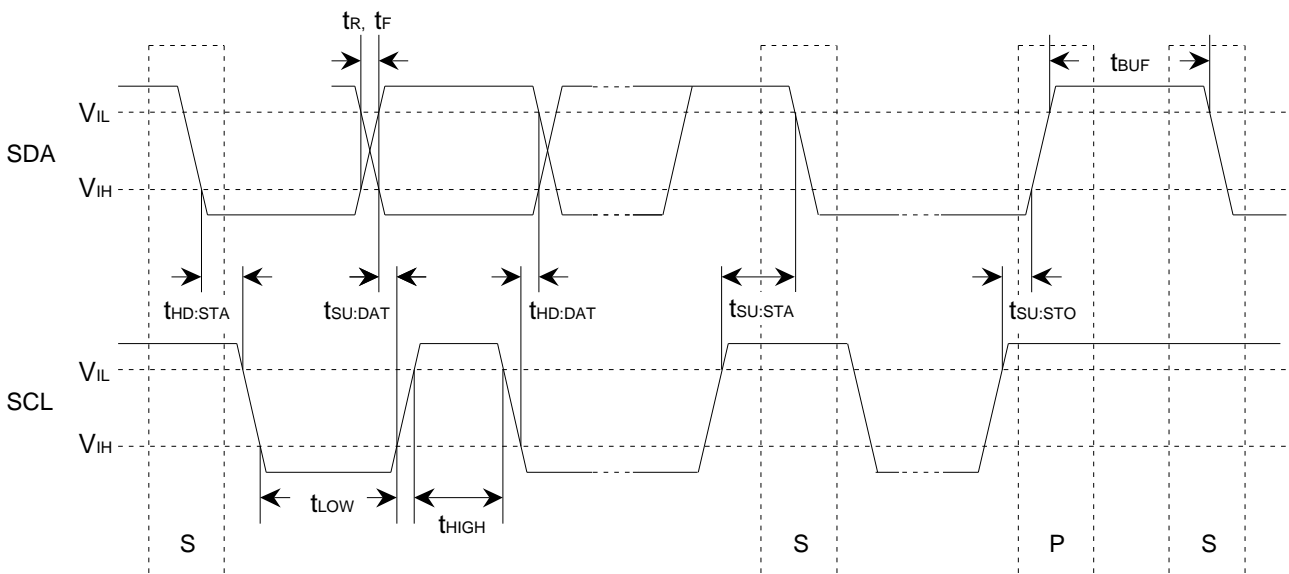

M52749FP

BUS CONTROLLED 3CH VIDEO PRE-AMP FOR CRT DISPLAY MONITOR

Supplementary Table1 Electrical Characteristics (Vcc = 12V,5V; Ta = 25°C unless otherwise specified)

No	parameter	Symbol	Test Point(s)	Input							CTL voltage		BUS CTL (H)										Standard			Unit	Re-mark
				(2)(6)(11) RGB In	(1) OSD BLK	(4)(9)(13) OSD In	(21) CP In	(30) ReT BLK	(7) SOG In	(34) Bright	(17) ABL	00H Main cont	01H Sub cont 1	02H Sub cont 2	03H Sub cont 3	04H OSD Adj	06H D/A OUT1	07H D/A OUT2	08H D/A OUT3	09H D/A OUT4	10AH D/A OUT5	MIN	TYP	MAX			
1	Circuit current1	Icc1	IA	a	a	a	a	a	a	a	a	4.0	5.0	FFH 255	FFH 255	FFH 255	FFH 255	FFH 255	FFH 255	-	110	130	mA	Note1			
2	Circuit current2	Icc2	IB	a	a	a	a	a	a	a	a	4.0	5.0	FFH 255	FFH 255	FFH 255	FFH 255	FFH 255	FFH 255	-	18	22	mA	Note2			
3	Output dynamic range	Vomax	OUT	b SG2	a	a	b SG5	a	a	a	Variable	5.0	5.0	FFH 255	FFH 255	FFH 255	FFH 255	FFH 255	FFH 255	6.0	8.0	-	Vp-p	Note3			
4	Maximum input	Vimax	IN OUT	b SG2 Variable	a	a	b SG5	a	a	a	2.0	5.0	64H 100	FFH 255	FFH 255	FFH 255	FFH 255	FFH 255	FFH 255	1.6	-	-	Vp-p	Note4			
5	Maximum gain	Gv	OUT	b SG1	a	a	b SG5	a	a	a	2.0	5.0	FFH 255	FFH 255	FFH 255	FFH 255	FFH 255	FFH 255	16.5	17.7	19.4	dB	Note5				
6	Relative maximum gain	ΔGv	-	-	-	-	-	-	-	-	-	-	-	-	-	-	-	-	-	0.8	1.0	1.2	-	Note6			
7	Main contrast control characteristics 1	VC1	OUT	b SG1	a	a	b SG5	a	a	a	2.0	5.0	C8H 200	FFH 255	FFH 255	FFH 255	FFH 255	FFH 255	15.5	17.0	18.5	dB	Note7				
8	Main contrast control relative characteristics 1	ΔVC1	-	-	-	-	-	-	-	-	-	-	-	-	-	-	-	-	-	0.8	1.0	1.2	-	Note8			
9	Main contrast control characteristics 2	VC2	OUT	b SG1	a	a	b SG5	a	a	a	2.0	5.0	64H 100	FFH 255	FFH 255	FFH 255	FFH 255	FFH 255	9.0	10.5	12.0	dB	Note9				
10	Main contrast control relative characteristics 2	ΔVC2	-	-	-	-	-	-	-	-	-	-	-	-	-	-	-	-	-	0.8	1.0	1.2	-	Note10			
11	Main contrast control characteristics 3	VC3	OUT	b SG1	a	a	b SG5	a	a	a	2.0	5.0	14H 20	FFH 255	FFH 255	FFH 255	FFH 255	FFH 255	0.2	0.4	0.6	Vp-p	Note11				
12	Main contrast control relative characteristics 3	ΔVC3	-	-	-	-	-	-	-	-	-	-	-	-	-	-	-	-	-	0.8	1.0	1.2	-	Note12			
13	Sub contrast control characteristics 1	VSC1	OUT	b SG1	a	a	b SG5	a	a	a	2.0	5.0	FFH 255	C8H 200	C8H 200	C8H 200	C8H 200	C8H 200	15.5	17.0	18.5	dB	Note13				
14	Sub contrast control relative characteristics 1	ΔVSC1	-	-	-	-	-	-	-	-	-	-	-	-	-	-	-	-	-	0.8	1.0	1.2	-	Note14			
15	Sub contrast control characteristics 2	VSC2	OUT	b SG1	a	a	b SG5	a	a	a	2.0	5.0	FFH 255	64H 100	64H 100	64H 100	64H 100	64H 100	10.5	12.0	13.5	dB	Note15				
16	Sub contrast control relative characteristics 2	ΔVSC2	-	-	-	-	-	-	-	-	-	-	-	-	-	-	-	-	-	0.8	1.0	1.2	-	Note16			

M52749FP

BUS CONTROLLED 3CH VIDEO PRE-AMP FOR CRT DISPLAY MONITOR

No	parameter	Symbol	Test Point(s)	Input							CTL voltage		BUS CTL (H)												Standard			Unit	Re-mark
				(2)(6)(11) RGB In	(1) OSD BLK In	(4)(9)(13) OSD In	(21) CP In	(30) ReT BLK In	(7) SOG In	(34) Bright	(17) ABL	00H Main cont	01H Sub cont 1	02H Sub cont 2	03H Sub cont 3	04H OSD Adj	06H D/A OUT1	07H D/A OUT2	08H D/A OUT3	09H D/A OUT4	10AH D/A OUT5	MIN	TYP	MAX					
17	Sub contrast control characteristics 3	VSC3	OUT	b SG1	a	a	b SG5	a	a	a	2.0	5.0	FFH 255	14H 20	14H 20	14H 20	00H 0	FFH 255	FFH 255	FFH 255	0.7	1.2	1.5	Vp-p	Note17				
18	Sub contrast control relative characteristics 3	ΔVSC3	-	-	-	-	-	-	-	-	-	-	-	-	-	-	-	-	-	-	0.8	1.0	1.2	-	Note18				
19	Main/sub contrast control characteristics	VMSC	OUT	b SG1	a	a	b SG5	a	a	a	2.0	5.0	C8H 200	C8H 200	C8H 200	C8H 200	00H 200	FFH 255	FFH 255	FFH 255	3.4	4.0	4.6	Vp-p	Note19				
20	Main/sub contrast control relative characteristics	ΔVMSC	-	-	-	-	-	-	-	-	-	-	-	-	-	-	-	-	-	-	0.8	1.0	1.2	-	Note20				
21	ABL control characteristics 1	ABL1	OUT	b SG1	a	a	b SG5	a	a	a	2.0	4.0	FFH 255	FFH 255	FFH 255	FFH 255	00H 255	FFH 255	FFH 255	FFH 255	4.6	5.4	6.2	Vp-p	Note21				
22	ABL control relative characteristics 1	ΔABL1	-	-	-	-	-	-	-	-	-	-	-	-	-	-	-	-	-	-	0.8	1.0	1.2	-	Note22				
23	ABL control characteristics 2	ABL2	OUT	b SG1	a	a	b SG5	a	a	a	2.0	2.0	-	-	-	-	-	-	-	-	2.3	2.8	3.3	Vp-p	Note23				
24	ABL control relative characteristics 2	ΔABL2	-	-	-	-	-	-	-	-	-	-	-	-	-	-	-	-	-	-	0.8	1.0	1.2	-	Note24				
25	Brightness control characteristics 1	VB1	OUT	a	a	a	b SG5	a	a	a	4.0	5.0	-	-	-	-	-	-	-	-	3.6	4.0	4.4	V	Note25				
26	Brightness control relative characteristics 1	ΔVB1	-	-	-	-	-	-	-	-	-	-	-	-	-	-	-	-	-	-	-0.3	0	0.3	V	Note26				
27	Brightness control characteristics 2	VB2	OUT	a	a	a	b SG5	a	a	a	2.0	5.0	-	-	-	-	-	-	-	-	1.8	2.1	2.4	V	Note27				
28	Brightness control relative characteristics 2	ΔVB2	-	-	-	-	-	-	-	-	-	-	-	-	-	-	-	-	-	-	-0.3	0	0.3	V	Note28				
29	Brightness control characteristics 3	VB3	OUT	a	a	a	b SG5	a	a	a	1.0	5.0	-	-	-	-	-	-	-	-	0.9	1.1	1.3	V	Note29				
30	Brightness control relative characteristics 3	ΔVB3	-	-	-	-	-	-	-	-	-	-	-	-	-	-	-	-	-	-	-0.3	0	0.3	V	Note30				
31	Frequency characteristics 1 (f=50MHz)	FC1	OUT	b SG3	a	a	a	a	a	a	Variable	5.0	-	-	-	-	-	-	-	-	-2.0	0	2.5	dB	Note31				
32	Frequency relative characteristics 1 (f=50MHz)	ΔFC1	-	-	-	-	-	-	-	-	-	-	-	-	-	-	-	-	-	-	-1.0	0	1.0	dB	Note32				

M52749FP

BUS CONTROLLED 3CH VIDEO PRE-AMP FOR CRT DISPLAY MONITOR

No	parameter	Symbol	Test Point(s)	Input							CTL voltage		BUS CTL (H)												Standard			Unit	Re-mark										
				①	②⑥⑪	④⑨⑬	⑫	⑭	⑮	⑯	⑰	⑳	㉑	㉒	㉓	㉔	㉕	㉖	㉗	㉘	㉙	㉚	㉛	㉜	MIN	TYP	MAX												
33	Frequency characteristics 1 (f=180MHz)	FC1'	OUT	a	b SG3	a	a	a	a	a	a	5V	a	Bright	5.0	Variable	5.0	00H Main cont	00H Sub cont 1	01H Sub cont 2	02H Sub cont 3	03H Sub cont 4	04H OSD Adj	06H D/A OUT1	07H D/A OUT2	08H D/A OUT3	09H D/A OUT4	0AH D/A OUT5	FFH 255	FFH 255	FFH 255	FFH 255	0	0	3.0	dB	Note33		
34	Frequency relative characteristics 1 (f=180MHz)	△FC1'	-	-	-	-	-	-	-	-	-	-	-	-	-	-	-	-	-	-	-	-	-	-	-	-	-	-	-	-	-	-	-	-	-	-	-	dB	Note34
35	Frequency characteristics 2 (f=180MHz)	FC2	OUT	a	b SG3	a	a	a	a	a	a	5V	a	Variable	5.0	Variable	5.0	-	-	-	-	-	-	-	-	-	-	-	-	-	-	-	-	-	-	-	-	dB	Note35
36	Frequency relative characteristics 2 (f=180MHz)	△FC2	-	-	-	-	-	-	-	-	-	-	-	-	-	-	-	-	-	-	-	-	-	-	-	-	-	-	-	-	-	-	-	-	-	-	dB	Note36	
37	Crosstalk 1 (f=50MHz)	CT1	OUT(33) OUT(38)	a	2 b SG3 6 a 11a	a	a	a	a	a	a	5V	a	Variable	5.0	Variable	5.0	FFH 255	-	-	-	-	-	-	-	-	-	-	-	-	-	-	-	-	-	-	-	dB	Note37
38	Crosstalk 1 (f=180MHz)	CT1'	OUT(33) OUT(38)	a	2 b SG3 6 a 11a	a	a	a	a	a	a	5V	a	Variable	5.0	Variable	5.0	-	-	-	-	-	-	-	-	-	-	-	-	-	-	-	-	-	-	-	-	dB	Note38
39	Crosstalk 2 (f=50MHz)	CT2	OUT(33) OUT(41)	a	2 a 6 b SG3 11a	a	a	a	a	a	a	5V	a	Variable	5.0	Variable	5.0	-	-	-	-	-	-	-	-	-	-	-	-	-	-	-	-	-	-	-	-	dB	Note39
40	Crosstalk 2 (f=180MHz)	CT2'	OUT(33) OUT(41)	a	2 a 6 b SG3 11a	a	a	a	a	a	a	5V	a	Variable	5.0	Variable	5.0	-	-	-	-	-	-	-	-	-	-	-	-	-	-	-	-	-	-	-	-	dB	Note40
41	Crosstalk 3 (f=50MHz)	CT3	OUT(38) OUT(41)	a	2 a 6 a 11b SG3	a	a	a	a	a	a	5V	a	Variable	5.0	Variable	5.0	-	-	-	-	-	-	-	-	-	-	-	-	-	-	-	-	-	-	-	-	dB	Note41
42	Crosstalk 3 (f=180MHz)	CT3'	OUT(38) OUT(41)	a	2 a 6 a 11b SG3	a	a	a	a	a	a	5V	a	Variable	5.0	Variable	5.0	-	-	-	-	-	-	-	-	-	-	-	-	-	-	-	-	-	-	-	-	dB	Note42
43	Pulse characteristics 1 (3Vp-p)	Tr	OUT	a	b SG1	a	a	a	a	a	a	SG5	a	Variable	5.0	Variable	5.0	Variable	-	-	-	-	-	-	-	-	-	-	-	-	-	-	-	-	-	-	nS	Note43	
44	Pulse characteristics 2 (3Vp-p)	Tf	OUT	a	b SG1	a	a	a	a	a	a	SG5	a	Variable	5.0	Variable	5.0	Variable	-	-	-	-	-	-	-	-	-	-	-	-	-	-	-	-	-	-	nS	Note44	
45	Clamp pulse threshold voltage	VthCP	OUT	a	b SG1	a	a	a	a	a	a	SG5 Variable	a	2.0	5.0	5.0	FFH 255	-	-	-	-	-	-	-	-	-	-	-	-	-	-	-	-	-	-	-	V	Note45	
46	Clamp pulse minimum width	WCP	OUT	a	b SG1	a	a	a	a	a	a	SG5 Variable	a	2.0	5.0	5.0	FFH 255	-	-	-	-	-	-	-	-	-	-	-	-	-	-	-	-	-	-	-	-	uS	Note46

M52749FP

BUS CONTROLLED 3CH VIDEO PRE-AMP FOR CRT DISPLAY MONITOR

No	parameter	Symbol	Test Point(s)	Input							CTL voltage		BUS CTL (H)										Standard			Unit	Re-mark
				(2)(6)(11) RGB In	(1) OSD BLK	(4)(9)(13) OSD In	(21) CP In	(30) ReT BLK	(7) SOG In	(34) Bright	(17) ABL	00H Main cont	01H Sub cont 1	02H Sub cont 2	03H Sub cont 3	04H OSD Adj	06H D/A OUT1	07H D/A OUT2	08H D/A OUT3	09H D/A OUT4	10AH D/A OUT5	MIN	TYP	MAX			
47	OSD pulse characteristics 1	OTr	OUT	a	a	b SG6	b SG5	a	a	a	2.0	5.0	FFH 255	FFH 255	FFH 255	FFH 255	FFH 255	FFH 255	FFH 255	-	3.0	6.0	ns	Note47			
48	OSD pulse characteristics 2	OTf	OUT	a	a	b SG6	b SG5	a	a	a	2.0	5.0	08H 8							-	3.0	6.0	ns	Note48			
49	OSD adjust control characteristics 1	Oaj1	OUT	a	b SG6	b SG6	b SG5	a	a	a	2.0	5.0	0FH 15							2.8	3.5	4.2	Vp-p	Note49			
50	OSD adjust control relative characteristics 1	△Oaj1	-	-	-	-	-	-	-	-	-	-	-	-	-	-	-	-	-	0.8	1.0	1.2	-	Note50			
51	OSD adjust control characteristics 2	Oaj2	OUT	a	b SG6	b SG6	b SG5	a	a	a	2.0	5.0	08H 8							2.25	2.8	3.35	Vp-p	Note51			
52	OSD adjust control relative characteristics 2	△Oaj2	-	-	-	-	-	-	-	-	-	-	-	-	-	-	-	-	-	0.8	1.0	1.2	-	Note52			
53	OSD adjust control characteristics 3	Oaj3	OUT	a	b SG6	b SG6	b SG5	a	a	a	2.0	5.0	00H 0							1.2	1.5	1.8	Vp-p	Note53			
54	OSD adjust control relative characteristics 3	△Oaj3	-	-	-	-	-	-	-	-	-	-	-	-	-	-	-	-	-	0.8	1.0	1.2	-	Note54			
55	OSD input threshold voltage	VthOSD	OUT	a	b SG6	b SG6 Variable	b SG5	a	a	a	2.0	5.0	08H 8							2.2	2.7	3.2	V	Note55			
56	OSD BLK input threshold voltage	VthBLK	OUT	b SG1	b SG6 Variable	a	b SG5	a	a	a	2.0	5.0	00H 0							2.2	2.7	3.2	V	Note56			
57	Retrace BLK characteristics 1	HBLK1	OUT	a	a	a	b SG5	b SG7	a	a	2.0	5.0								-	0.3	0.6	V	Note57			
60	Retrace BLK input threshold voltage	VthRET	OUT	a	a	a	b SG5	b SG7 Variable	a	a	2.0	5.0								1.0	1.5	2.0	V	Note60			
61	SOG input maximum noise voltage	SS - NV	SonG IN SyncOUT	a	a	a	a	a	a	b SG4 Variable	2.0	5.0								-	-	0.03	Vp-p	Note61			
62	SOG minimum input voltage	SS - SV	SonG IN SyncOUT	a	a	a	a	a	a	b SG4 Variable	2.0	5.0								0.2	-	-	Vp-p	Note62			

M52749FP

BUS CONTROLLED 3CH VIDEO PRE-AMP FOR CRT DISPLAY MONITOR

- Note1) Measuring conditions are as listed in supplementary Table. Measured with a current meter at test point IA.
- Note2) Measuring conditions are as listed in supplementary Table. Measured with a current meter at test point IB.
- Note3) Decrease V34 gradually, and measure the voltage when the bottom of waveform output is distorted. The voltage is called VOL.
Next, increase V34 gradually, and measure the voltage when the top of waveform output is distorted. The voltage is called VOH.
Voltage Vomax is calculated by the equation below:

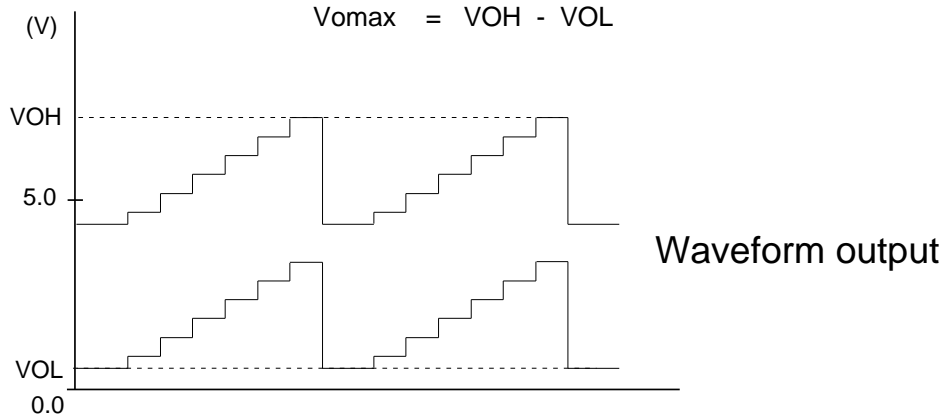

- Note4) Increase the input signal(SG2) amplitude gradually, starting from 700mVp-p. Measure the amplitude of the input signal when the output signal starts becoming distorted.
- Note5) Input SG1, and read the amplitude output at OUT(33,38,41). The amplitude is called VOUT(33,38,41).Maximum gain GV is calculated by the equation below:
$$GV=20 \text{ LOG } \frac{V_{OUT}}{0.7} \text{ (dB)}$$
- Note6) Relative maximum gain ΔGV is calculated by the equation below:
$$\Delta GV=V_{OUT}(33)/V_{OUT}(38), V_{OUT}(38)/V_{OUT}(41), V_{OUT}(41)/V_{OUT}(33)$$
- Note7) Measuring the amplitude output at OUT(33,38,41). The measured value is called VOUT(33,38,41). Main contrast control characteristics VC1 is calculated by the equation below:
$$VC1=20 \text{ LOG } \frac{V_{OUT}}{0.7} \text{ (dB)}$$
- Note8) Relative characteristics $\Delta VC1$ is calculated by the equation below:
$$\Delta VC1=V_{OUT}(33)/V_{OUT}(38) , V_{OUT}(38)/V_{OUT}(41) , V_{OUT}(41)/V_{OUT}(33)$$
- Note9) Measuring condition and procedure are the same as described in Note7.
- Note10) Measuring condition and procedure are the same as described in Note8.
- Note11) Measuring the amplitude output at OUT(33,38,41). The measured value is called VOUT(33,38,41).
- Note12) Measuring condition and procedure are the same as described in Note8.

Note13) Measure the amplitude output at OUT(33,38,41). The measured value is called VOUT(33,38,41). Sub contrast control characteristics VSC1 is calculated by the equation below:

$$VSC1=20 \text{ LOG } \frac{VOUT}{0.7} \quad (\text{dB})$$

Note14) Relative characteristics $\Delta VSC1$ is calculated by the equation below:

$$\Delta VSC1=VOUT(33)/VOUT(38) , VOUT(38)/VOUT(41) , VOUT(41)/VOUT(33)$$

Note15) Measuring condition and procedure are the same as described in Note13.

Note16) Measuring condition and procedure are the same as described in Note14.

Note17) Measure the amplitude output at OUT(33,38,41). The measured value is called VOUT(33,38,41).

Note18) Measuring condition and procedure are the same as described in Note14.

Note19) Measure the amplitude output at OUT(33,38,41). The measured value is called VMSC.

Note20) Relative characteristics $\Delta VMSC$ is calculated by the equation below:

$$\Delta VMSC=VOUT(33)/VOUT(38) , VOUT(38)/VOUT(41) , VOUT(41)/VOUT(33)$$

Note21) Measure the amplitude output at OUT(33,38,41). The measured value is called VOUT(33,38,41), and is treated as ABL1.

Note22) Relative characteristics ABL1 is calculated by the equation below:

$$ABL1=VOUT(33)/VOUT(38) , VOUT(38)/VOUT(41) , VOUT(41)/VOUT(33)$$

Note23) Measuring condition and procedure are the same as described in Note21.

Note24) Measuring condition and procedure are the same as described in Note22.

Note25) Measure the DC voltage at OUT(33,38,41) with a voltmeter. The measured value is called VOUT(33,38,41), and is treated as VB1.

Note26) Relative characteristics $\Delta VB1$ is calculated by the difference in the output between the channels.

$$\Delta VB1=VOUT(33)\text{Å}VOUT(38) , VOUT(38)\text{Å}VOUT(41) , VOUT(41)\text{Å}VOUT(33)$$

Note27) Measuring condition and procedure are the same as described in Note25.

Note28) Measuring condition and procedure are the same as described in Note26.

Note29) Measuring condition and procedure are the same as described in Note25.

Note30) Measuring condition and procedure are the same as described in Note26.

M52749FP

BUS CONTROLLED 3CH VIDEO PRE-AMP FOR CRT DISPLAY MONITOR

Note31) First, SG3 to 1MHz is as input signal. Input a resistor that is about 2KOhm to offer the voltage at input pins(2,6,11) in order that the bottom of input signal is 2.5V.
Control the main contrast in order that the amplitude of sine wave output is 4.0Vp-p.
Control the brightness in order that the bottom of sine wave output is 2.0Vp-p.
By the same way, measure the output amplitude when SG3 to 50MHz is as input signal.
The measured value is called VOUT(33,38,41).
Frequency characteristics FC1(33,38,41) is calculated by the equation below:

$$FC1=20 \text{ LOG } \frac{VOUT \text{ Vp-p}}{\text{output amplitude when inputted SG3(1MHz) : 4.0Vp-p}} \text{ (dB)}$$

Note32) Relative characteristics $\Delta FC1$ is calculated by the difference in the output between the channels.

Note33) Measuring condition and procedure are the same as described in Note31,except SG3 to 180MHz.

Note34) Relative characteristics $\Delta FC1'$ is calculated by the difference in the output between the channels.

Note35) SG3 to 1MHz is as input signal. Control the main contrast in order that the amplitude of sine wave output is 1.0Vp-p.
By the same way, measure the output amplitude when SG3 to 150MHz is as input signal.
The measured value is called VOUT(33,38,41).
Frequency characteristics FC2(33,38,41) is calculated by the equation below:

$$FC2=20 \text{ LOG } \frac{VOUT \text{ Vp-p}}{\text{output amplitude when inputted SG3(1MHz) : 4.0Vp-p}} \text{ (dB)}$$

Note36) Relative characteristics $\Delta FC2$ is calculated by the difference in the output between the channels.

Note37) Input SG3 (50MHz) to pin2 only, and then measure the waveform amplitude output at OUT(33,38,41).The measured value is called VOUT(33,38,41).
Crosstalk CT1 is calculated by the equation below:

$$CT1=20 \text{ LOG } \frac{VOUT(33,38)}{VOUT(41)} \text{ (dB)}$$

Note38) Measuring condition and procedure are the same as described in Note37,except SG3 to 180MHz.

Note39) Input SG3 (50MHz) to pin6 only, and then measure the waveform amplitude output at OUT(33,38,41).The measured value is called VOUT(33,38,41).
Crosstalk CT2 is calculated by the equation below:

$$CT2=20 \text{ LOG } \frac{VOUT(33,41)}{VOUT(38)} \text{ (dB)}$$

Note40) Measuring condition and procedure are the same as described in Note39,except SG3 to 180MHz.

Note41) Input SG3 (50MHz) to pin11 only, and then measure the waveform amplitude output at OUT(33,38,41).The measured value is called VOUT(33,38,41).
Crosstalk CT2 is calculated by the equation below:

$$CT3=20 \text{ LOG } \frac{VOUT(38,41)}{VOUT(33)} \text{ (dB)}$$

Note42) Measuring condition and procedure are the same as described in Note41,except SG3 to 180MHz.

- Note43) Control the main contrast (00H) in order that the amplitude of output signal is 3.0Vp-p.
Control the brightness (V34) in order that the Black level of output signal is 2.0V.
Measure the time needed for the input pulse to rise from 10% to 90% (Tr1) and for the output pulse to rise from 10% to 90% (Tr2) with an active probe.
Pulse characteristics Tr is calculated by the equations below :

$$Tr = \sqrt{(Tr2)^2 - (Tr1)^2} \text{ (nsec)}$$

- Note44) Measure the time needed for the input pulse to fall from 90% to 10% (Tf1) and for the output pulse to fall from 90% to 10% (Tf2) with an active probe.
Pulse characteristics Tf is calculated by the equations below :

$$Tf = \sqrt{(Tf2)^2 - (Tf1)^2} \text{ (nsec)}$$

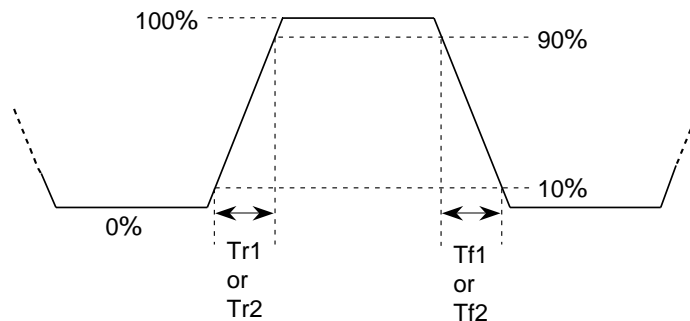

- Note45) Turn down the SG5 input level gradually from 5.0Vp-p, monitoring the waveform output. Measure the top level of input pulse when the output pedestal voltage turn decrease with unstable.
- Note46) Decrease the SG5 pulse width gradually from 0.5us, monitoring the output. Measure the SG5 pulse width (a point of 1.5V) when the output pedestal voltage turn decrease with unstable.

M52749FP

BUS CONTROLLED 3CH VIDEO PRE-AMP FOR CRT DISPLAY MONITOR

- Note47) Measure the time needed for the output pulse to rise from 10% to 90% (OTr) with an active probe.
- Note48) Measure the time needed for the output pulse to fall from 90% to 10% (OTf) with an active probe.
- Note49) Measure the amplitude output at OUT(33,38,41). The measured value is called VOUT(33,38,41), and is treated as Oaj1.
- Note50) Relative characteristics $\Delta Oaj1$ is calculated by the equation below:

$$\Delta Oaj1 = \frac{VOUT(33)}{VOUT(38)} \cdot \frac{VOUT(38)}{VOUT(41)} \cdot \frac{VOUT(41)}{VOUT(33)}$$
- Note51) Measuring condition and procedure are the same as described in Note49.
- Note52) Measuring condition and procedure are the same as described in Note50.
- Note53) Measuring condition and procedure are the same as described in Note49.
- Note54) Measuring condition and procedure are the same as described in Note50.
- Note55) Reduce the SG6 input level gradually, monitoring output.
 Measure the SG6 level when the output reaches 0V. The measured value is called VthOSD.
- Note56) Confirm that output signal is being blanked by the SG6 at the time.
 Monitoring to output signal, decreasing the level of SG6. Measure the top level of SG6 when the blanking period is disappeared. The measured value is called VthBLK.
- Note57) Measure the amplitude output is blanked by the SG7 at OUT(33,38,41). The measured value is called VOUT(33,38,41), and is treated as HBLK1.
- Note60) Confirm that output signal is being blanked by the SG7 at the time.
 Monitoring to output signal, decreasing the level of SG7. Measure the top level of SG7 when the blanking period is disappeared. The measured value is called VthRET.

M52749FP

BUS CONTROLLED 3CH VIDEO PRE-AMP FOR CRT DISPLAY MONITOR

- Note61) The sync's amplitude of SG4 be changed all white into all black, increase from 0Vp-p to 0.02Vp-p. No pulse output permitted.
- Note62) The sync's amplitude of SG4 be changed all white or all black, decrease from 0.3Vp-p to 0.2Vp-p. Confirm no malfunction produced by noise.
- Note63) Measure the high voltage at SyncOUT. The measured value is treated as VSH.
- Note64) Measure the low voltage at SyncOUT. The measured value is treated as VSL.
- Note65) SyncOUT becomes High with sink part of SG4.
Measure the time needed for the rear edge of SG4 sink to fall from 50% and for SyncOUT to rise from 50% with an active prove. The measured value is treated as TDS-F ,less than 90nsec.
- Note66) Measure the time needed for the rear edge of SG4 sink to rise from 50% and for SyncOUT to fall from 50% with an active prove. The measured value is treated as TDS-R ,less than 90nsec.

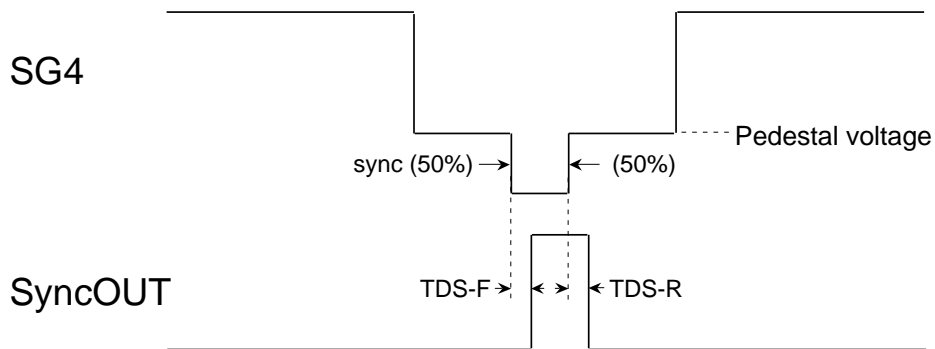

- Note67) Measure the DC voltage at D/AOUT. The measured value is treated as VOH.
- Note68) Measure the DC voltage at D/AOUT. The measured value is treated as VOL.
- Note69) IA- is minimum input-current when input 1Vdc to D/AOUT.

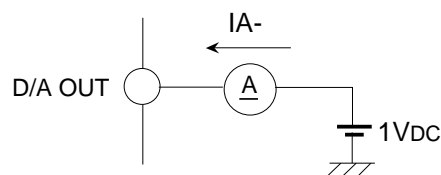

- Note69a) IA+ is maximum output-current from D/AOUT.
- Note70) The difference of differential non- linearity of D/AOUT must be less than ± 1.0 LSB.

M52749FP

BUS CONTROLLED 3CH VIDEO PRE-AMP FOR CRT DISPLAY MONITOR

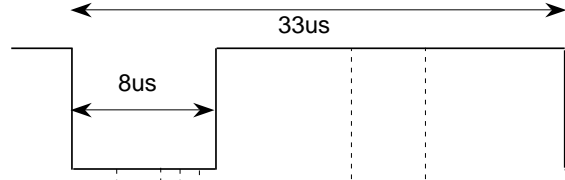
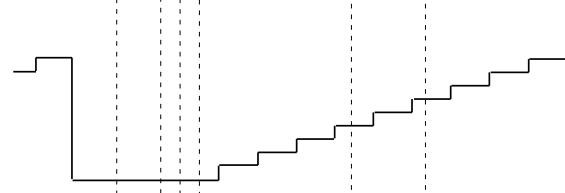
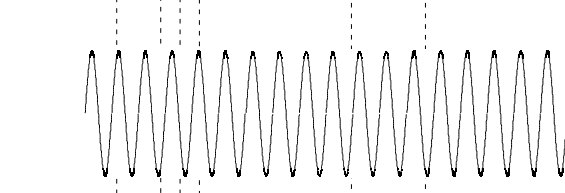
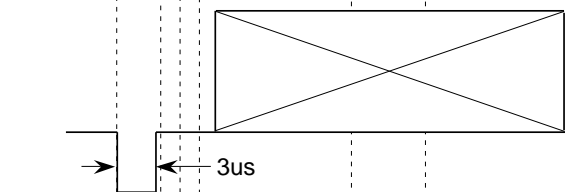
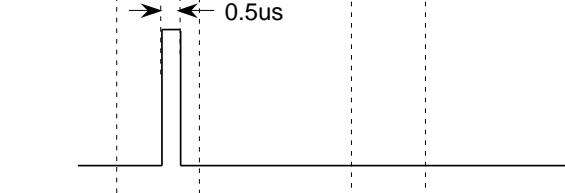
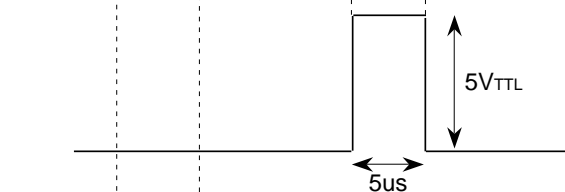
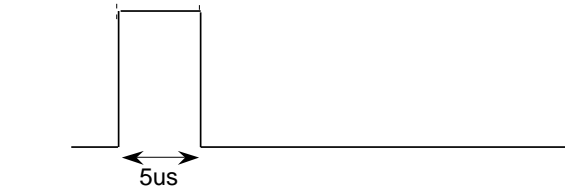
SG No.	INPUT SIGNAL
<p>SG1 Video signal (all white)</p>	 <p>Pulse with amplitude of 0.7Vp-p (f=30KHz). Video width of 25us. (75%) 0.7V_{PP}</p>
<p>SG2 Video signal (step wave)</p>	 <p>0.7V_{P-P} (Amplitude is variable.)</p>
<p>SG3 Sine wave (for freq. char.)</p>	 <p>Sine wave amplitude of 0.7Vp-p. f=1MHz,50MHz,180MHz(variable)</p>
<p>SG4 Videosignal (all white,all black)</p>	 <p>Video width of 25us. (75%) 0.7V_{PP} all white or all black variable. 0.3V_{PP} Sync's amplitude is variable.</p>
<p>SG5 Clamp pulse</p>	 <p>0.5us Pulse width and amplitude are variable. 5V_{TTL}</p>
<p>SG6 OSD pulse</p>	 <p>5us 5V_{TTL} Amplitude is variable.</p>
<p>SG7 BLK pulse</p>	 <p>5us 5V_{TTL} Amplitude is variable.</p>

f=30KHz

M52749FP

BUS CONTROLLED 3CH VIDEO PRE-AMP FOR CRT DISPLAY MONITOR

TEST CIRCUIT

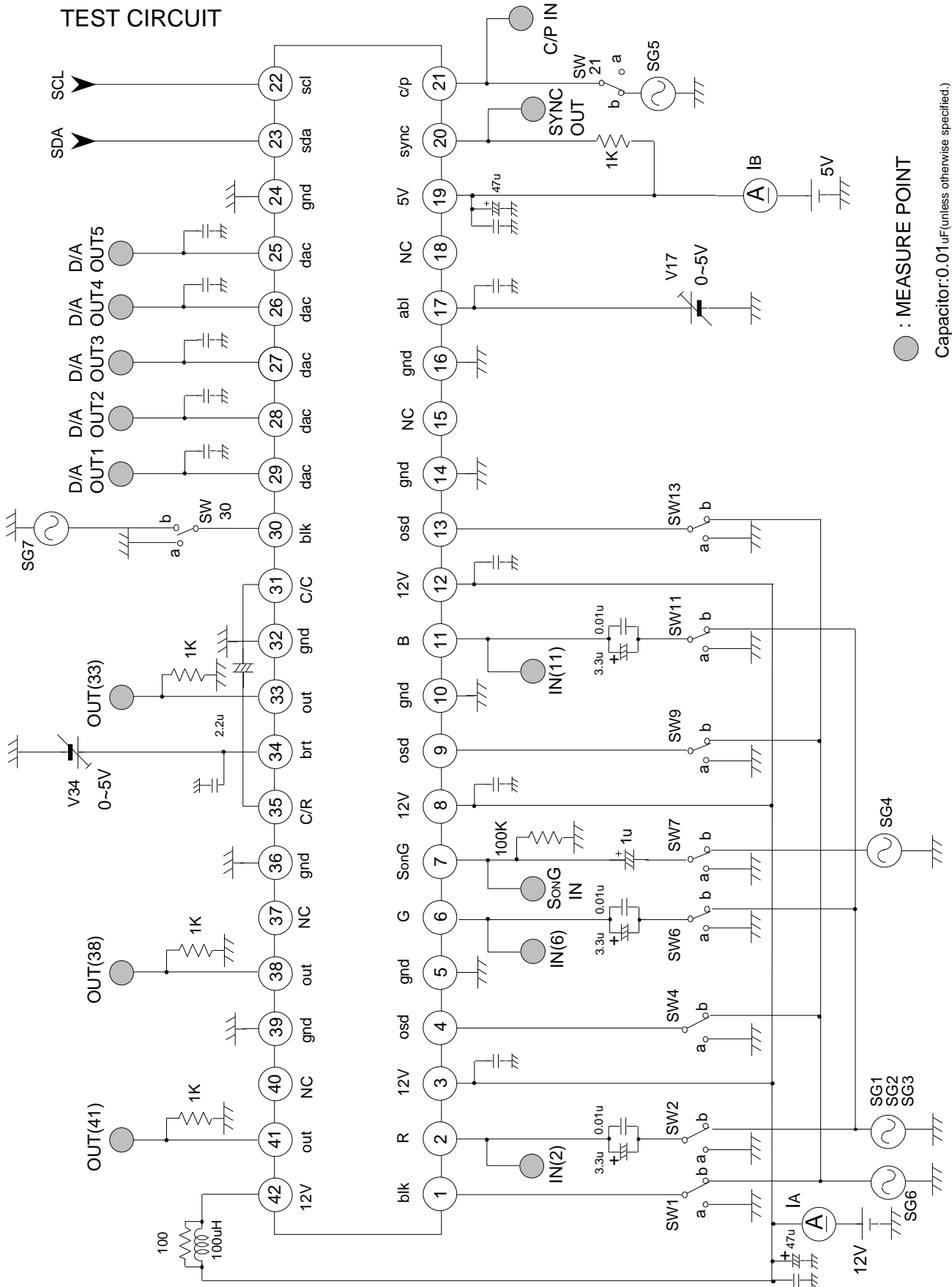

● : MEASURE POINT

Capacitor: 0.01 uF (unless otherwise specified.)

M52749FP

BUS CONTROLLED 3CH VIDEO PRE-AMP FOR CRT DISPLAY MONITOR

Terminal Description

No.	Name	DC Voltage (V)	peripheral Circuit	Remark
1	OSD BLK IN	—		<ul style="list-style-type: none"> Input pulses <ul style="list-style-type: none"> Connected to GND if not used.
2 6 11	INPUT (R) INPUT (G) INPUT (B)	2.5		<ul style="list-style-type: none"> Clamped to about 2.5 V due to clamp pulses from pin 21. Input at low impedance.
3 8 12	VCC 1(R) VCC 1(G) VCC 1(B)	12		<ul style="list-style-type: none"> Apply equivalent voltage to 3 channels.
4 9 13	OSD IN (R) OSD IN (G) OSD IN (B)	—		<ul style="list-style-type: none"> Input pulses <ul style="list-style-type: none"> Connected to GND if not used.
5 10 14 16 24 32 36 39	GND1(R) GND1(G) GND GND1(B) GND(5V) GND GND GND 2	GND		

M52749FP

BUS CONTROLLED 3CH VIDEO PRE-AMP FOR CRT DISPLAY MONITOR

No.	Name	DC Voltage (V)	peripheral Circuit	Remark
7	INPUT (S on G)	When open 2.5V		<p>SYNC ON VIDEO input pin . Sync is negative . input signal at Pin7 , compare with the reference voltage of internal circuit in order to separate sync signal from Sync on Green signal .</p>
17	ABL IN	When open 2.5V		<p>ABL(AutomaticBeamLimiter) input pin. Recommended voltage range is 0 to 5V. When ABL function is not used, set to 5V.</p>
15 18 37 40	NC	—	_____	_____
19	VCC(5V)	5	_____	_____
20	SonG Sep OUT	—		<p>Sync signal output pin, Being of open collector output type.</p>

M52749FP

BUS CONTROLLED 3CH VIDEO PRE-AMP FOR CRT DISPLAY MONITOR

No.	Name	DC Voltage (V)	peripheral Circuit	Remark
21	Clamp Pulse IN	—		<p>Input pulses</p> <p>Input at low impedance.</p>
22	SCL	—		<p>SCL of I²CBUS (Serialclockline) V_{TH}=2.3V</p>
23	SDA	—		<p>SDA of I²CBUS (Serialdataline) V_{TH}=2.3V</p>
25 26 27 28 29	D/A OUT	—		<p>D/A output pin. Output voltage range is 0~5V. Min input current is 0.18mA when D/A output pin is 1V. Max output current is 1.0mA.</p>

M52749FP

BUS CONTROLLED 3CH VIDEO PRE-AMP FOR CRT DISPLAY MONITOR

No.	Name	DC Voltage (V)	peripheral Circuit	Remark	
30	Retrace BLK IN	—		<p>Input pulses</p> <p>Connected to GND if not used.</p>	
31	Main Contrast Cont	3.5-5.5		<ul style="list-style-type: none"> Non-polar capacitance is required between pin31 and pin35. 	
35	Main Contrast Ref	4.5			
33	OUTPUT (B)	Variable		<p>A resistor is needed on the GND side. Set discretionally to maximum 15 mA, depending on the required driving capacity.</p>	
38	OUTPUT (G)				<p>Used to supply power to output emitter follower only.</p>
41	OUTPUT (R)				
42	VCC 2	12			
34	Main Brightness	—		<p>It is recommended that the IC be used between pedestal voltage 2V and 3V.</p>	

Electrical Characteristics

Main Contrast Control Characteristics

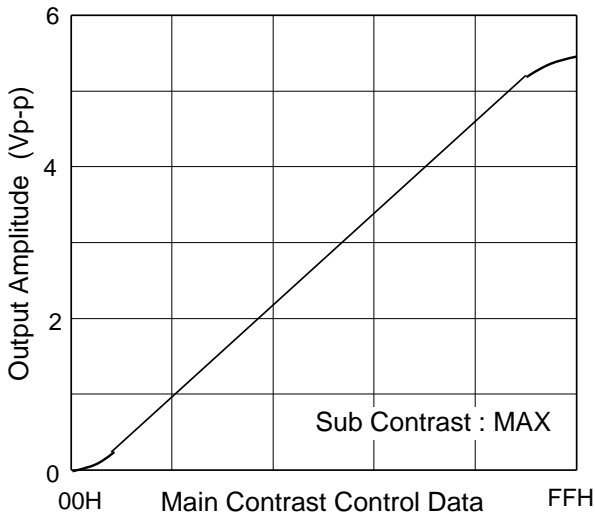

Sub Contrast Control Characteristics

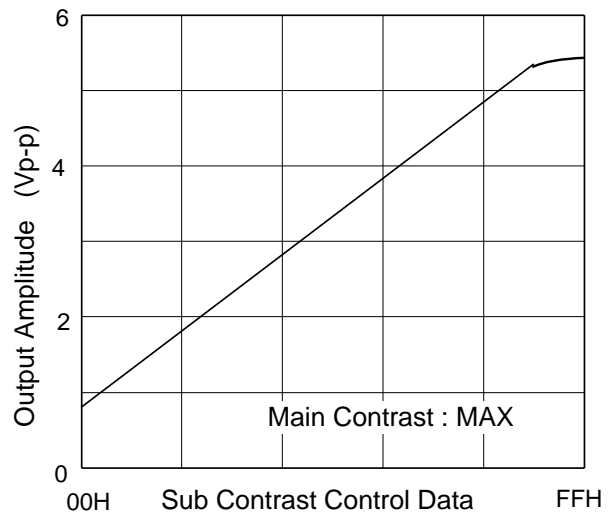

Brightness Control Characteristics

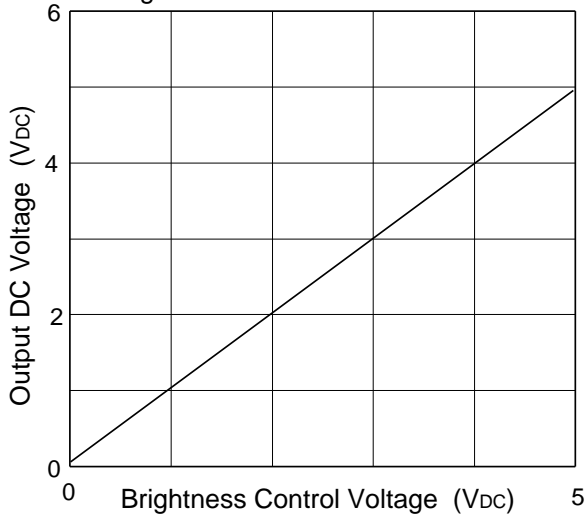

ABL Characteristics

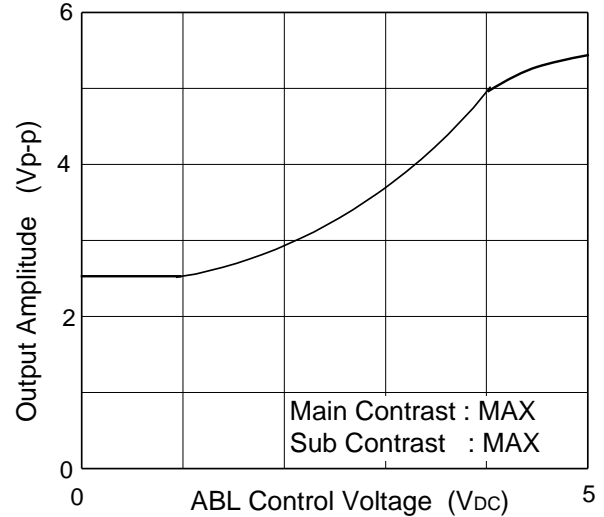

OSD Adjust Control Characteristics

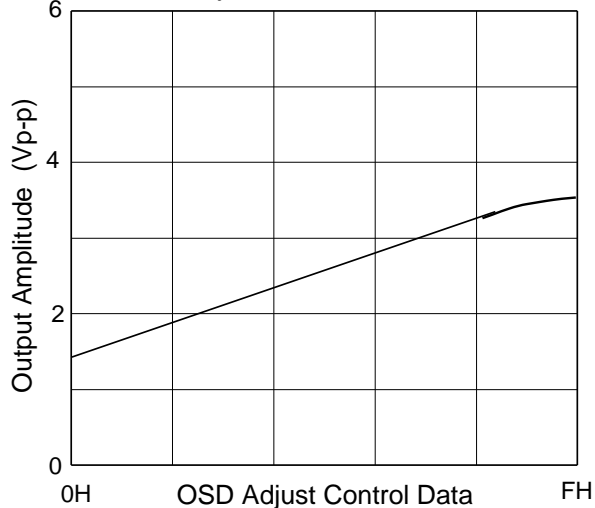

Sync separate input min sync width

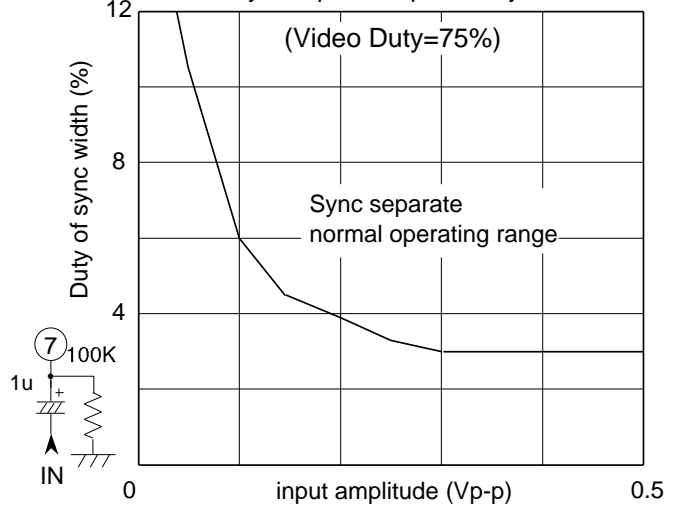

Application Method for M52749SP

CLAMP PULSE INPUT

Clamp pulse width is recommended

- above 15 KHz, 1.0 usec
- above 30 KHz, 0.5 usec
- above 64 KHz, 0.3 usec .

The clamp pulse circuit in ordinary set is a long round about way, and beside high voltage, sometimes connected to external terminal, it is very easy affected by large surge. Therefore, the Fig. shown right is recommended.

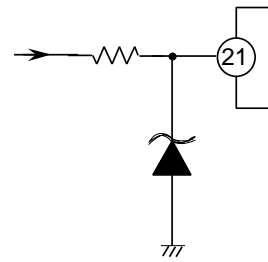

Notice of application

Make the nearest distance between output pin and pull down resistor.
Recommended pedestal voltage of IC output signal is 2V.

M52749FP

BUS CONTROLLED 3CH VIDEO PRE-AMP FOR CRT DISPLAY MONITOR

APPLICATION EXAMPLE

