



PC Card (PCMCIA) Interface Switch—12-V Suspend Capability

FEATURES

- Programmable V_{CC} Ramp
- Smart Switching
- 12-V Sleepmode Compatible
- Extremely Low R_{ON}
- Reverse Blocking Switches
- V_{PP} Programmable to 0, 12-V or V_{CC}
- Safe Power-Up
- Low Power Consumption
- PC Card 3-V/5-V Compatible
- Logic Compatible Inputs
- Single SO-16 Package

DESCRIPTION

The Si9712 combines low on-resistance with slow ramp time and smart switching for overall best performance in integrated PC Card interface switches.

The Si9712 operates off the 5-V supply and has built-in level shifting for gate drive. Internal logic protects against an external control input error that would short 5 V to the 3.3-V supply. This protection logic also allows the Si9712 to be configured for positive or negative control logic for compatibility with a variety of PC Card controllers. These control inputs are CMOS logic compatible and can be driven to 3.3 V or 5 V.

The Si9712 complies with the release of the PC Card standard by supplying 0 V, 12 V, and V_{CC} to the V_{PP} output and 0 V, 3.3 V, and 5 V to the V_{CC} output. The V_{CC} ramp time is user programmable with an external capacitor connected to the SR pin.

The PC Card switch is packaged in a narrow body SO-16 package and is rated over the industrial temperature range -40 to 85°C .

The Si9712 is available in both standard and lead (Pb)-free packages.

FUNCTIONAL BLOCK DIAGRAM

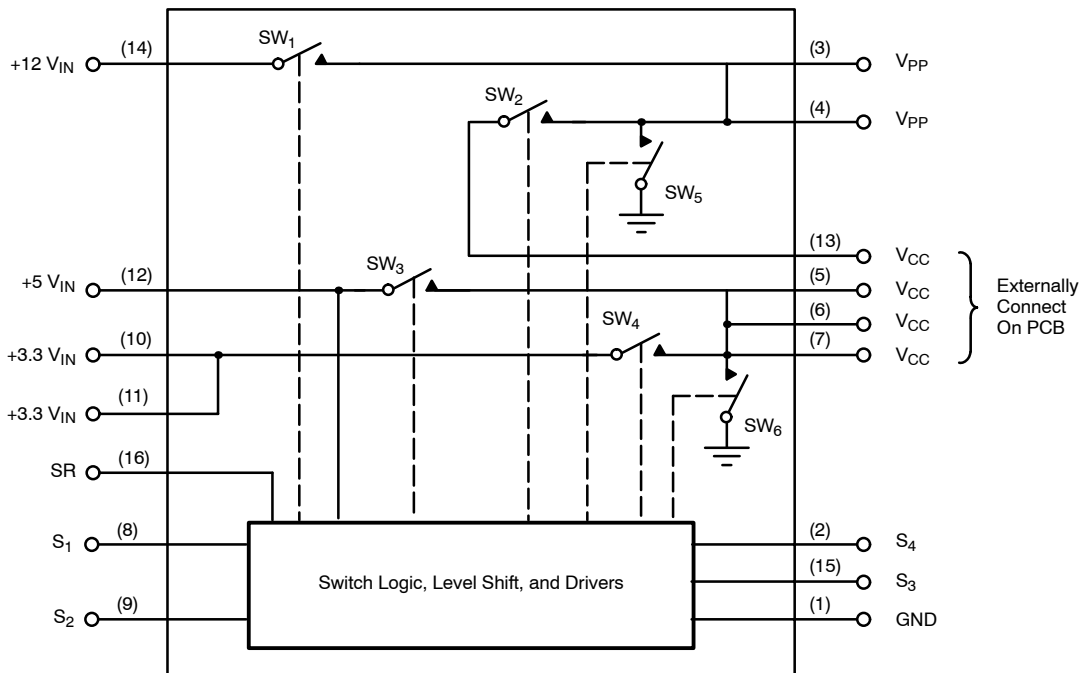



ABSOLUTE MAXIMUM RATINGS

Voltages Referenced to Ground	
+12 V _{IN}	15 V
+5 V _{IN}	7 V
+3.3 V _{IN} ^c	7 V
S ₁ through S ₄ (CMOS Inputs)	7 V
I _{OUT} V _{PP} ^a	300 mA
All Pins	-0.5 V
I _{OUT} V _{CC} ^b	4 A

PD Max: (T _A = 25°C)	2.5 W
(T _A = 85°C)	1.0 W
Junction Temperature	125°C
Thermal Rating—R _{ΘJA}	40 °C/W

Notes

- Pins 3, 4 connected together externally.
- Pins 5, 6, 7, 13 connected together externally.
- Pins 10, 11 connected together externally.

RECOMMENDED OPERATING CONDITIONS

+12 V _{IN}	0 or 12 V ± 10%
+5 V _{IN} (must be present)	5 V ± 10%
+3.3 V _{IN} ^c	3.3 V ± 10%
C _{SR}	33 nF
I _{OUT} V _{PP} ^a	150 mA
I _{OUT} V _{CC} ^b	2 A

V _{PP} Load Capacitance	10 μF Max
V _{CC} Load Capacitance	150 μF Max

Notes

- Pins 3, 4 connected together externally.
- Pins 5, 6, 7, 13 connected together externally.
- Pins 10, 11 connected together externally.

SPECIFICATIONS							
Parameter	Symbol	Test Conditions Unless Otherwise Specified		Limits -40 to 85°C			Unit
		C _{SR} = 33 nF, +12 V _{IN} = 12 V, +5 V _{IN} = 5 V +3.3 V _{IN} = 3.3 V, Low ≤ 0.8 V, High ≥ 2.2 V		Min ^a	Typ ^b	Max ^a	
Switch 1							
On-Resistance	R _{ON}	I = 120 mA, +12 V _{IN} = 11.4 V S ₃ = S ₁ = High S ₂ = S ₄ = Low	T _A = 25°C			120	mΩ
			T _A = 85°C			145	
Off Current (+12 V _{IN})	I _{OFF}	+12 V _{IN} = 12.6 V S ₁ = Low	T _A = 25°C			1	μA
			T _A = 85°C			10	
Switching Time	t _{SW1(on)}	S ₂ = S ₄ = Low, See Figure 1 S ₃ = High		50	200	350	μs
	t _{SW1(off)}				1.0	10	
Delay Time	t _{d(on)}	See Figure 3 S ₂ = S ₄ = Low		1.0	6	20	ms
	t _{d(off)}			0.1	2.9	10	
Rise Time	t _{SW1(on)}	S ₂ = S ₄ = Low, S ₃ = High, See Figure 2		50	150	300	μs
Switch 2							
On-Resistance	R _{ON}	I = 120 mA, S ₂ = S ₃ = High S ₁ = S ₄ = Low	T _A = 25°C			150	mΩ
			T _A = 85°C			180	
Switching Time	t _{SW2(on)}	S ₁ = S ₄ = Low, S ₃ = High, See Figure 1		50	200	350	μs
	t _{SW2(off)}				1.0	10	
Delay Time	t _{d(on)}	S ₁ = S ₄ = Low, See Figure 3		1.0	6	20	ms
	t _{d(off)}			0.1	1.7	10	
Rise Time	t _{SW2(on)}	S ₁ = S ₄ = Low, S ₃ = High, See Figure 2		50	150	300	μs
Switch 3							
On-Resistance	R _{ON}	I = 500 mA, S ₃ = High S ₁ = S ₂ = S ₄ = Low	T _A = 25°C			70	mΩ
			T _A = 85°C			95	
Off Current (V _{CC})	I _{OFF}	+5 V _{IN} = 5.5 V, V _{CC} = 0 V S ₁ = S ₂ = S ₃ = Low S ₄ = High +3.3 V _{IN} = Open Circuit	T _A = 25°C			1	μA
			T _A = 85°C			10	
Rise Time	t _{SW3(on)}	S ₁ = S ₂ = S ₄ = Low, See Figure 2		0.1	1.7	10	ms
Fall Time	t _{SW3(off)}			3	30	50	



SPECIFICATIONS							
Parameter	Symbol	Test Conditions Unless Otherwise Specified $C_{SR} = 33 \text{ nF}$, $+12 \text{ V}_{IN} = 12 \text{ V}$, $+5 \text{ V}_{IN} = 5 \text{ V}$ $+3.3 \text{ V}_{IN} = 3.3 \text{ V}$, Low $\leq 0.8 \text{ V}$, High $\geq 2.2 \text{ V}$		Limits -40 to 85°C			Unit
				Min ^a	Typ ^b	Max ^a	
Switch 4							
On-Resistance	R_{ON}	$I = 500 \text{ mA}$, $S_4 = \text{High}$ $S_1 = S_2 = S_3 = \text{Low}$	$T_A = 25^\circ\text{C}$			50	mΩ
			$T_A = 85^\circ\text{C}$			70	
Off Current (+3.3 V _{IN})	I_{OFF}	$+3.3 \text{ V}_{IN} = 3.6 \text{ V}$, $S_1 = S_2 = S_3 = S_4 = \text{Low}$	$T_A = 25^\circ\text{C}$			1	μA
			$T_A = 85^\circ\text{C}$			10	
Rise Time	$t_{SW4(on)}$	$S_1 = S_2 = S_3 = \text{Low}$, See Figure 2		0.1	0.9	10	ms
Fall Time	$t_{SW4(off)}$			3	20	40	
Switch 5							
On-Resistance	R_{ON}	$I = 2 \text{ mA}$, $S_1 = S_2 = \text{Low}$	$T_A = 25^\circ\text{C}$		235	400	Ω
			$T_A = 85^\circ\text{C}$		325	550	
Switch 6							
On-Resistance	R_{ON}	$I = 2 \text{ mA}$, $S_3 = S_4 = \text{Low}$	$T_A = 25^\circ\text{C}$		140	400	Ω
			$T_A = 85^\circ\text{C}$		200	500	
Power Supply							
+5 V _{IN} Current Input (on)	$I_{+5VIN(1)}$	$S_1 = S_4 = 0 \text{ V}$, $S_2 = S_3 = 3 \text{ V}$			20	50	μA
	$I_{+5VIN(2)}$	$S_1 = S_4 = 3 \text{ V}$, $S_2 = S_3 = 0 \text{ V}$			20	50	
+5 V _{IN} Current Input (off)	$I_{+5VIN(3)}$	$S_1 = S_2 = S_3 = S_4 = 0 \text{ V}$			<1	10	
Switch Control Inputs							
Input Voltage High	$V_{I(H)}$	$+5 \text{ V}_{IN} = 5.5 \text{ V}$		2.2	1.8		V
		$+5 \text{ V}_{IN} = 4.5 \text{ V}$		2.2	1.6		
Input Voltage Low	$V_{I(L)}$	$+5 \text{ V}_{IN} = 5.5 \text{ V}$			1.6	0.8	
		$+5 \text{ V}_{IN} = 4.5 \text{ V}$			1.4	0.8	
Input Current High	$I_{I(H)}$	S_1 through $S_4 = 5 \text{ V}$				1.0	μA
Input Current Low	$I_{I(L)}$	S_1 through $S_4 = \text{GND}$		-1.0			

Notes

- a. The algebraic convention whereby the most negative value is a minimum and the most positive a maximum.
- b. Typical values are for DESIGN AID ONLY, not guaranteed nor subject to production testing.

TIMING WAVEFORMS

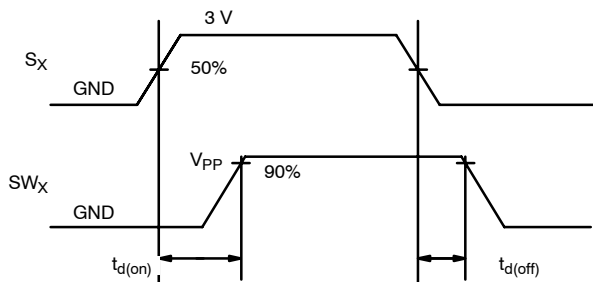

FIGURE 1. V_{PP} Switch Delay

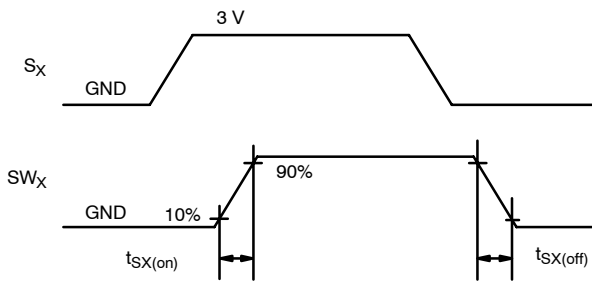

FIGURE 2. Switch Ramp

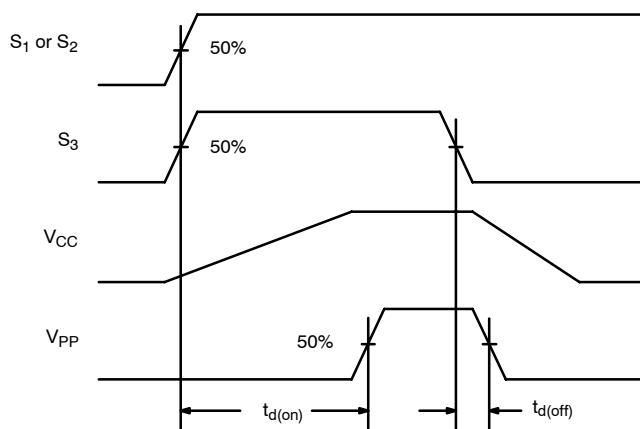
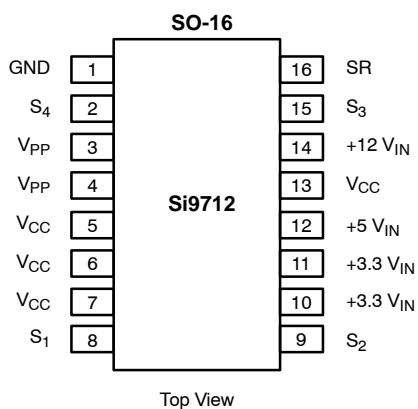

FIGURE 3. Delay from S_1 or S_2 to V_{PP} Power-up

PIN CONFIGURATION AND DESCRIPTION



Note: Pins 5, 6, 7, and 13 must be connected in the PCB for correct operation.

Pin Number	Function	Description
1.	GND	Ground connection.
2	S_4	Control input for selecting +3.3 V_{IN} to V_{CC} . The PC Card terminology for this pin is V_{CC_EN0} .
3, 4	V_{PP}	Program and peripheral voltage to PC Card slot.
5, 6, 7, 13	V_{CC}	Supply voltage to slot.
8	S_1	Control input for selecting +12 V_{IN} to V_{PP} . The PC Card terminology for this pin is V_{PP_EN1} .
9	S_2	Control input for selecting V_{CC} to V_{PP} . The PC Card terminology for this pin is V_{PP_EN0} .
10, 11	+3.3 V_{IN}	+3.3-V supply.
12	+5 V_{IN}	+5-V supply.
14	+12 V_{IN}	+12-V supply.
15	S_3	Control input for selecting +5 V_{IN} to V_{CC} . The PC Card terminology for this pin is V_{CC_EN1} .
16	SR	Slew rate control pin, capacitor to GND defines programmable ramp time.

ORDERING INFORMATION		
Part Number	Temperature Range	Package
Si9712DY	-40 to 85°C	SOIC-16
Si9712DY-T1		
Si9712DY-T1—E3		

TRUTH TABLE ^b									
S ₁	S ₂	S ₃	S ₄	Switch 1 ^a	Switch 2 ^a	Switch 3	Switch 4	Switch 5	Switch 6
0	0	0	0	Off	Off	Off	Off	On	On
0	0	0	1	Off	Off	Off	On	On	Off
0	0	1	0	Off	Off	On	Off	On	Off
0	0	1	1	Off	Off	Off	Off	On	On
0	1	0	0	Off	Off	Off	Off	On	On
0	1	0	1	Off	On	Off	On	Off	Off
0	1	1	0	Off	On	On	Off	Off	Off
0	1	1	1	Off	Off	Off	Off	On	On
1	0	0	0	Off	Off	Off	Off	On	On
1	0	0	1	On	Off	Off	On	Off	Off
1	0	1	0	On	Off	On	Off	Off	Off
1	0	1	1	Off	Off	Off	Off	On	On
1	1	0	0	Off	Off	Off	Off	On	On
1	1	0	1	On	Off	Off	On	Off	Off
1	1	1	0	On	Off	On	Off	Off	Off
1	1	1	1	Off	Off	Off	Off	On	On

Notes

- a. Turn on of switch 1 and 2 are internally delayed until after V_{CC} is valid. See Figure 3.
- b. Shaded lines are error conditions for PC Card applications, however, switches default to the states shown.

TIMING DIAGRAM

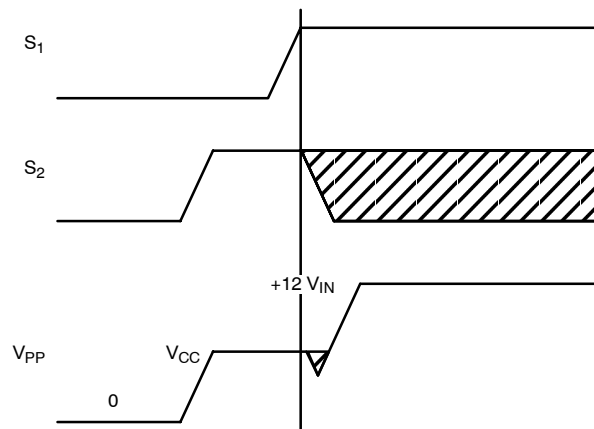
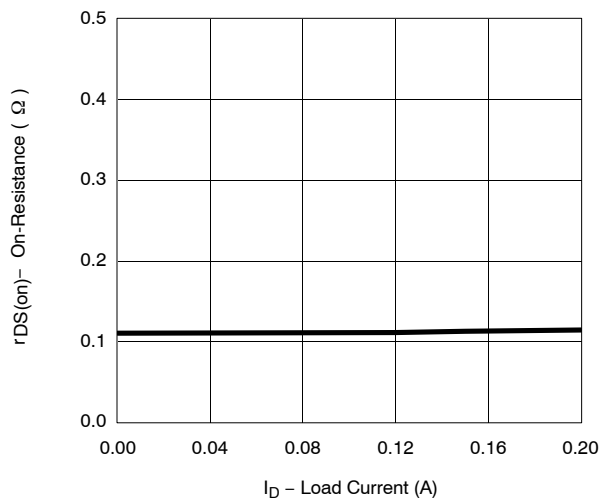

FIGURE 4. Break-Before-Make of SW₁ and SW₂



TYPICAL CHARACTERISTICS (25°C UNLESS OTHERWISE NOTED)

Switch 1—On-Resistance vs. Load Current



Switch 2—On-Resistance vs. Load Current

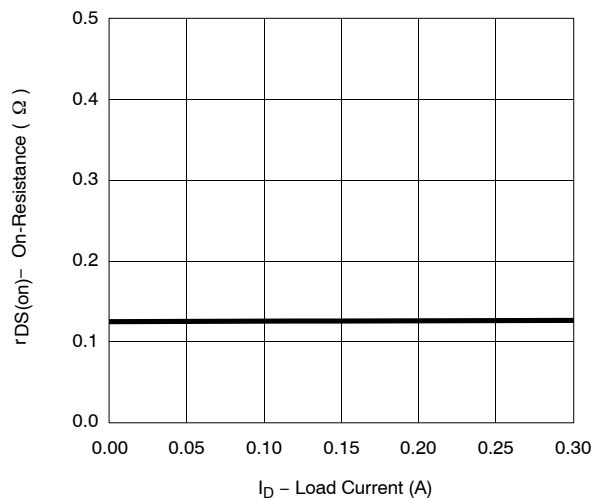

Switch 3—On-Resistance vs. Load Current

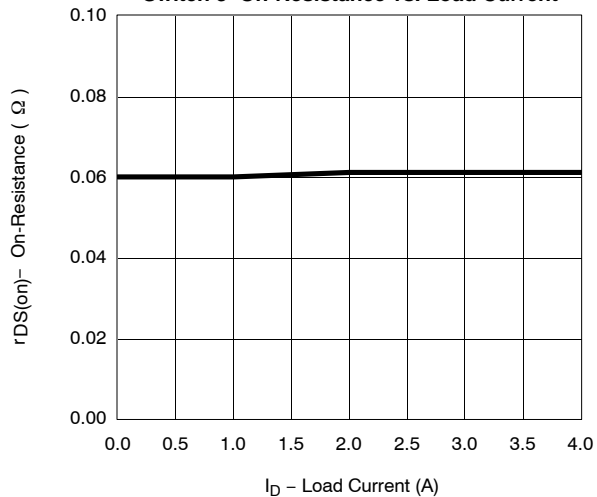

Switch 4—On-Resistance vs. Load Current

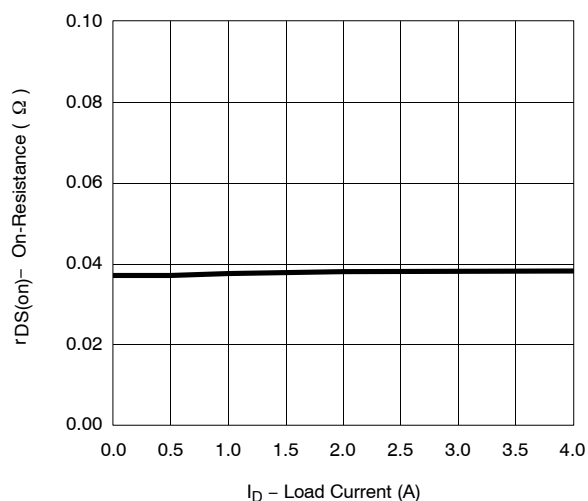

On-Resistance vs. Junction Temperature

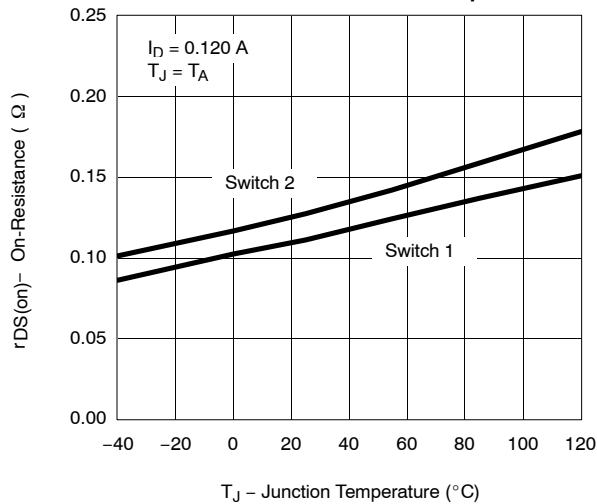

On-Resistance vs. Junction Temperature

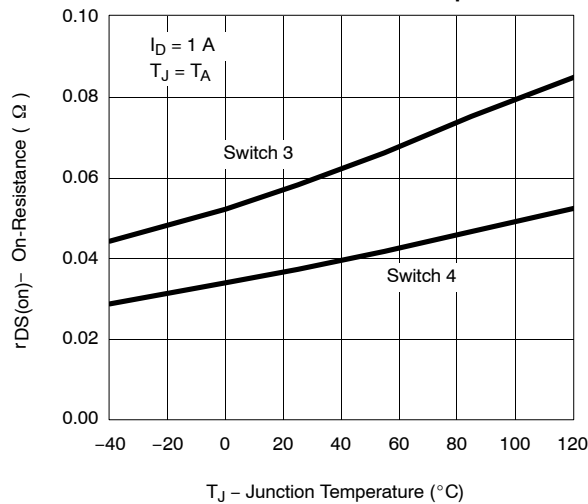



TYPICAL CHARACTERISTICS (25°C UNLESS OTHERWISE NOTED)

Rise Time vs. SR Capacitor Value

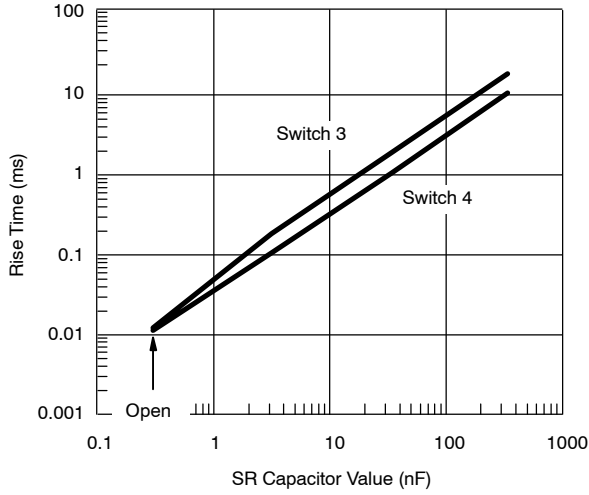

Fall Time vs. SR Capacitor Value

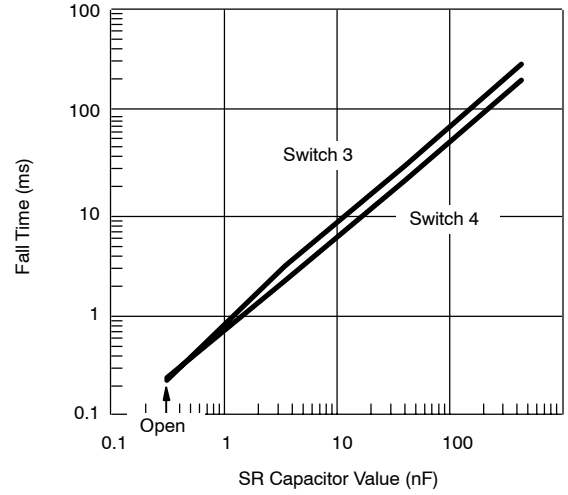

Switch 3
Rise Time vs. Load Capacitance

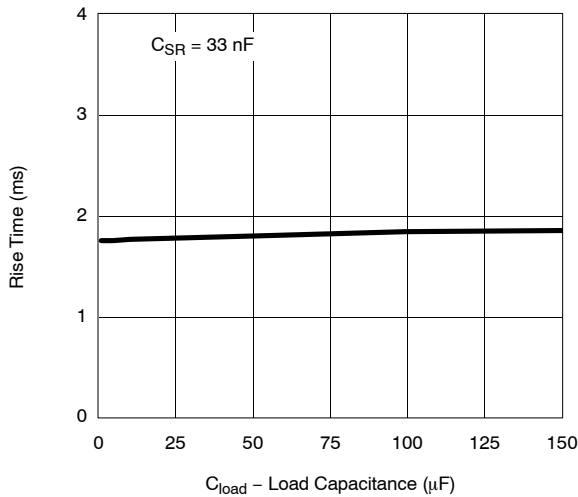

Switch 3
Fall Time vs. Load Capacitance

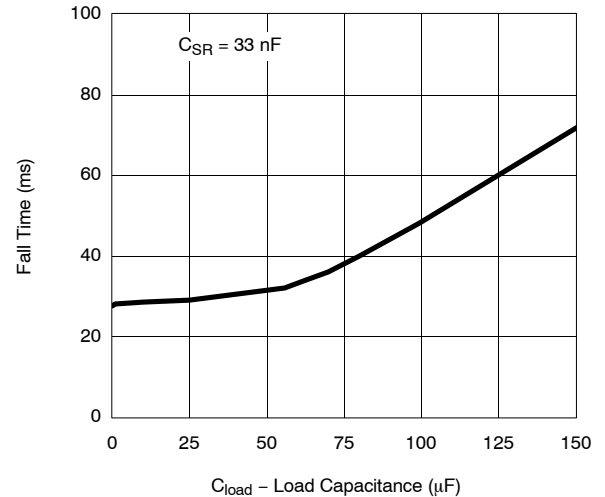

Switch 4
Rise Time vs. Load Capacitance

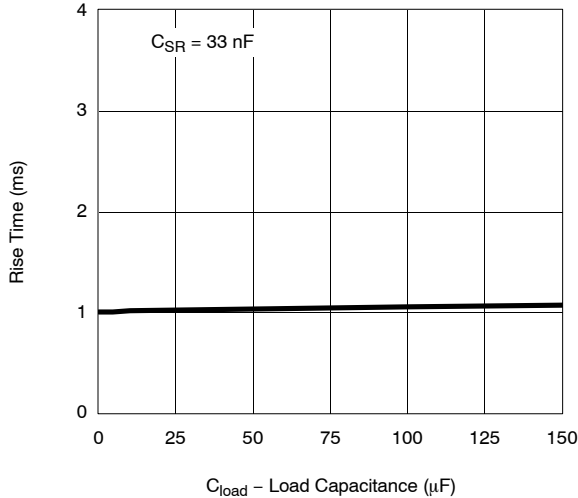

Switch 4
Fall Time vs. Load Capacitance

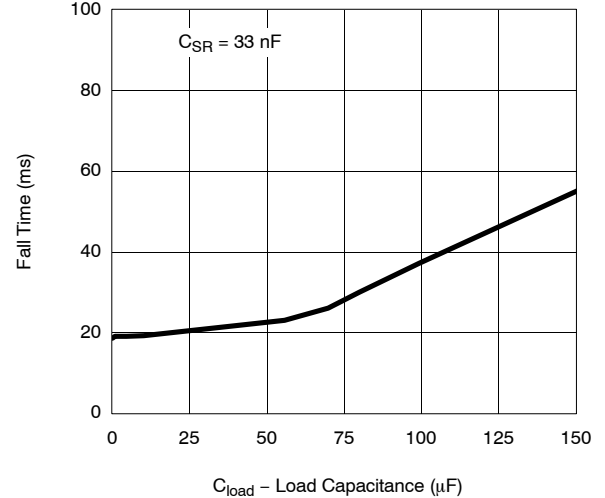



Disclaimer

All product specifications and data are subject to change without notice.

Vishay Intertechnology, Inc., its affiliates, agents, and employees, and all persons acting on its or their behalf (collectively, "Vishay"), disclaim any and all liability for any errors, inaccuracies or incompleteness contained herein or in any other disclosure relating to any product.

Vishay disclaims any and all liability arising out of the use or application of any product described herein or of any information provided herein to the maximum extent permitted by law. The product specifications do not expand or otherwise modify Vishay's terms and conditions of purchase, including but not limited to the warranty expressed therein, which apply to these products.

No license, express or implied, by estoppel or otherwise, to any intellectual property rights is granted by this document or by any conduct of Vishay.

The products shown herein are not designed for use in medical, life-saving, or life-sustaining applications unless otherwise expressly indicated. Customers using or selling Vishay products not expressly indicated for use in such applications do so entirely at their own risk and agree to fully indemnify Vishay for any damages arising or resulting from such use or sale. Please contact authorized Vishay personnel to obtain written terms and conditions regarding products designed for such applications.

Product names and markings noted herein may be trademarks of their respective owners.