

DETAILS

Product Number	CA12011_LAURA-SS-PIN
Family	Laura
Type	Assembly
Color	white
Diameter	21,6 x 21,6 mm
Height	13,1 mm
Style	square
Optic Material	PMMA
Holder Material	
Fastening	tape, pin
Status	production ready
ROHS Compliant	Yes
Date Updated	6/06/2017



OPTICAL PROPERTIES

LED	Viewing	Light	Effi-	cd/lm	Connector
	Angle	Beam	ciency		
XP-E	11 deg	Smooth spo...	.93 %	16.500	-
XP-G	12 deg	Smooth spo...	.94 %	-	-
XB-D	11 deg	Smooth spo...	.93 %	14.400	-
XP-E-HEW	12 deg	Smooth spo...	.92 %	11.700	-
LUXEON Rebel	11 deg	Smooth spo...	.92 %	16.000	-
LUXEON T	13 deg	Smooth spo...	.92 %	12.200	-
LUXEON Z ES	12 deg	Smooth spo...	.92 %	17.600	-
NCSxx19B	13 deg	Smooth spo...	.91 %	13.500	-
NF2x757D	14 deg	Smooth spo...	.91 %	11.700	-
SFH 4715S	sim: 12	Smooth spo...	-	-	-
Oslon Square PC	sim: 12	Smooth spo...	.89 %	15.870	-
Oslon SSL 80	11 deg	Smooth spo...	.91 %	13.500	-
Oslon SSL 150	11 deg	Smooth spo...	.91 %	12.500	-
Oslon Square EC	13 deg	Smooth spo...	.88 %	9.100	-
SFH 4725S	14 deg	Smooth spo...	-	-	-
Z5	10 deg	Smooth spo...	-	-	-

Relative intensity of CA12011_LAURA-SS-PIN_(Luxeon Z ES)

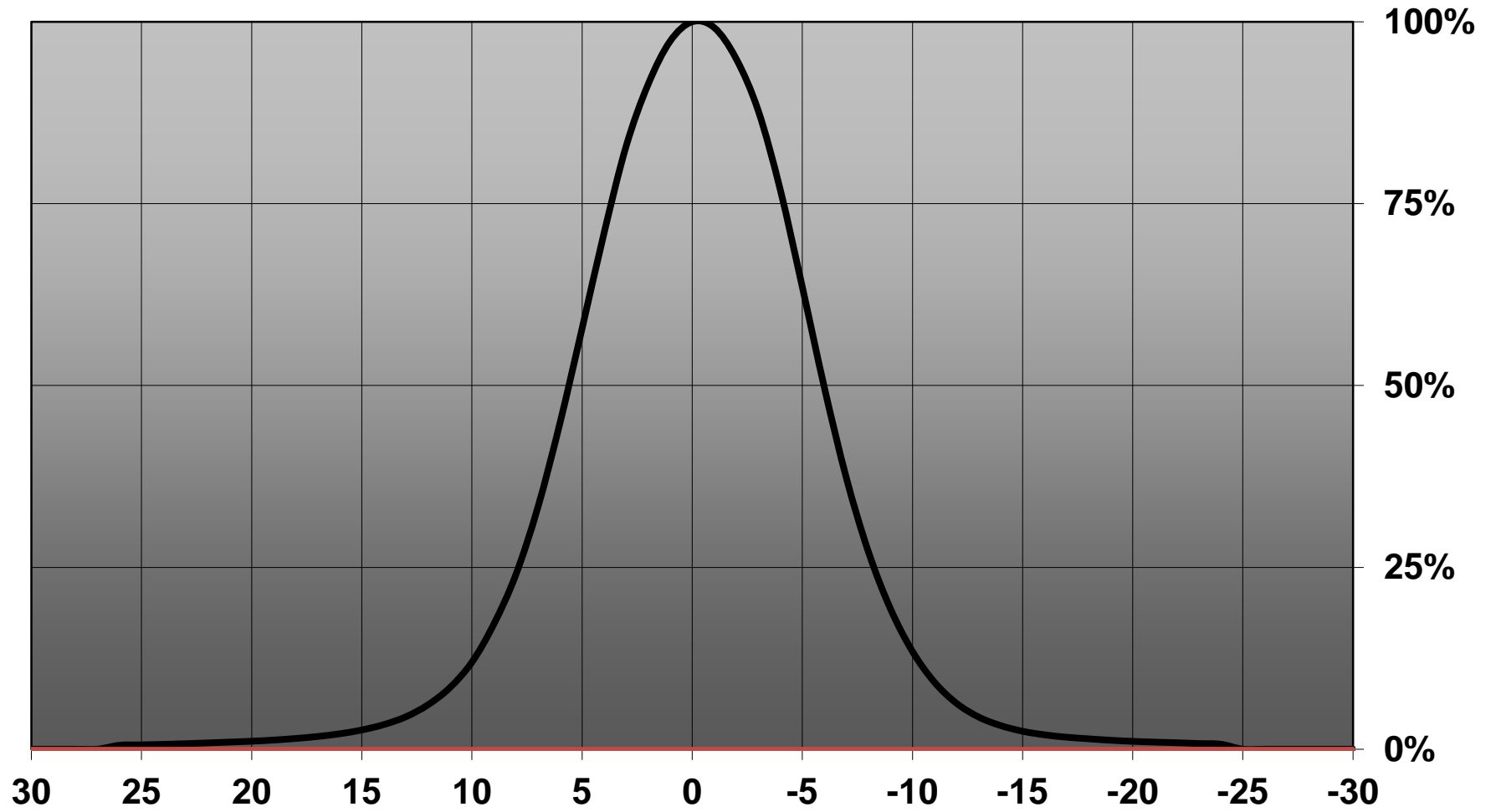

Relative intensity of CA12011_LAURA-SS-PIN_(SFH4725S)

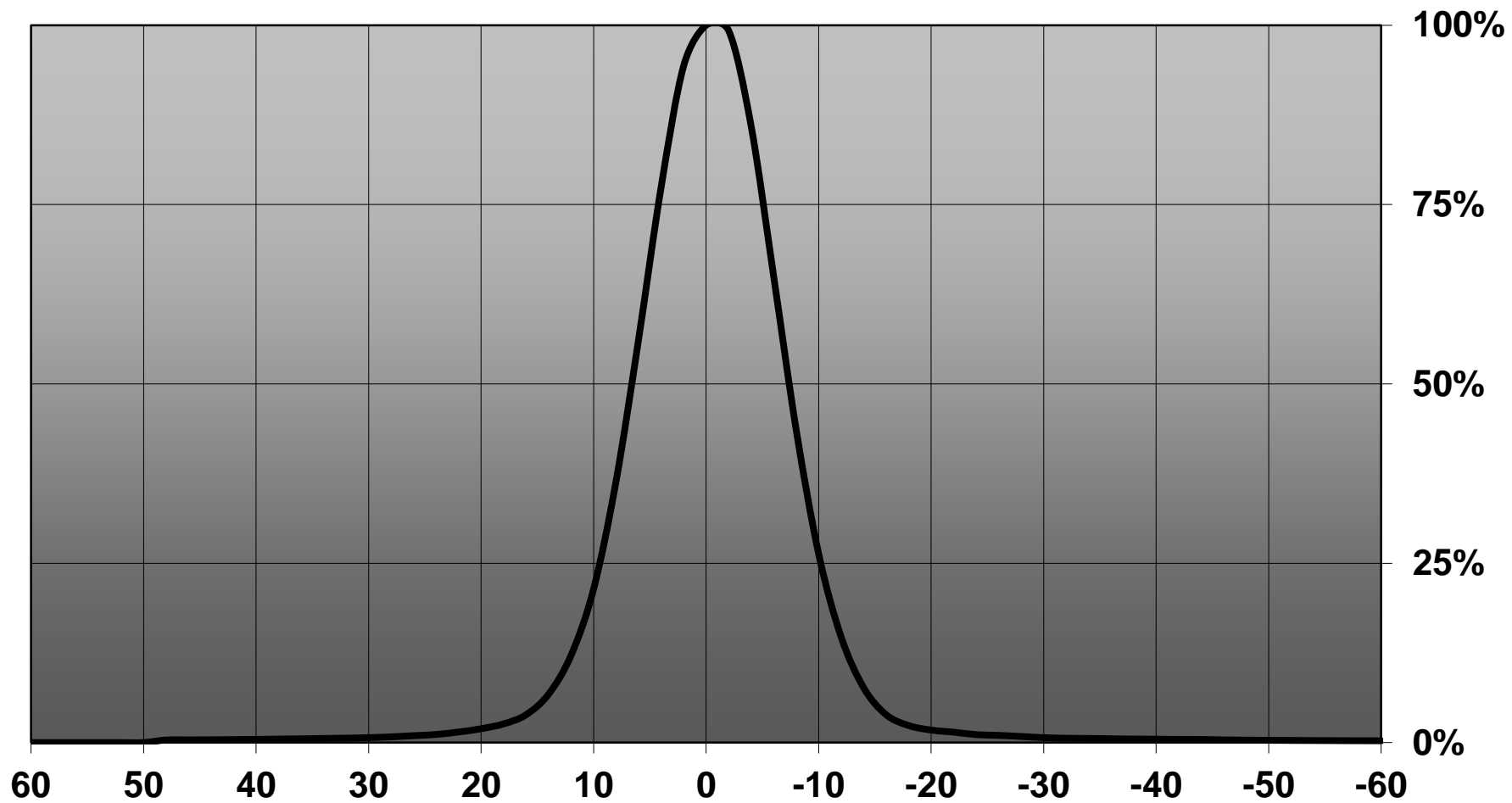

D

C

B

A

4

4

3

3

2

2

1

1

Bottom view

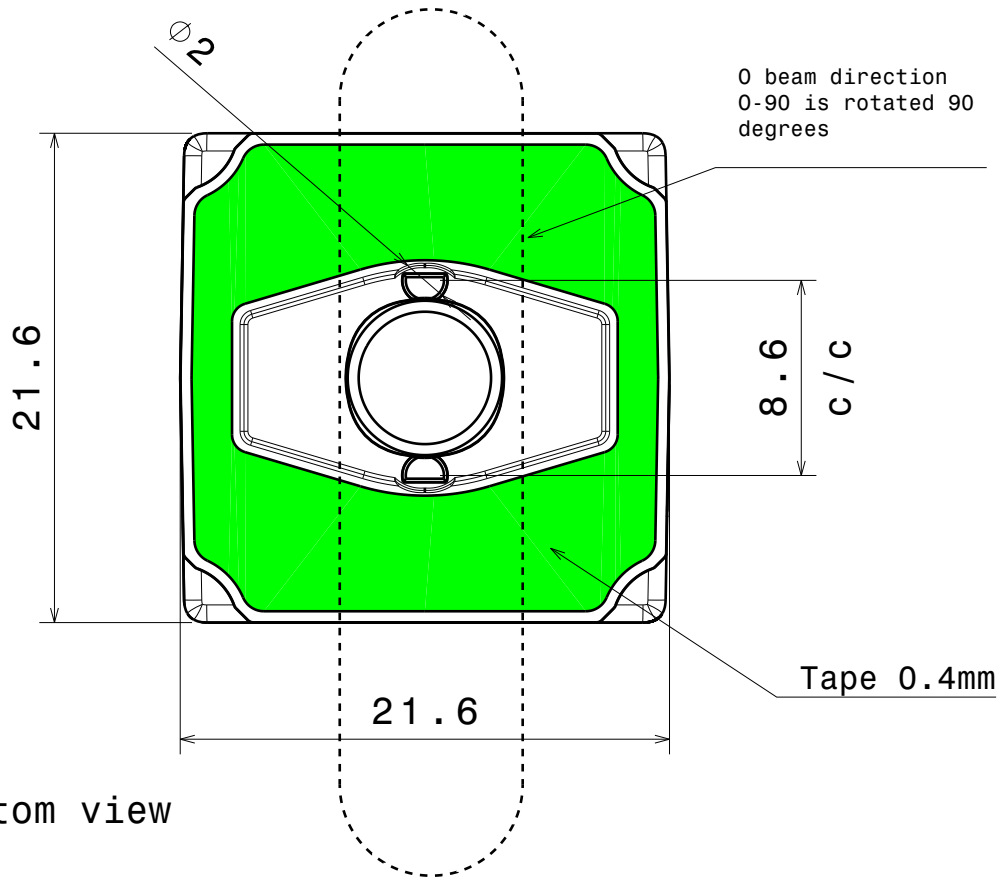

Front view

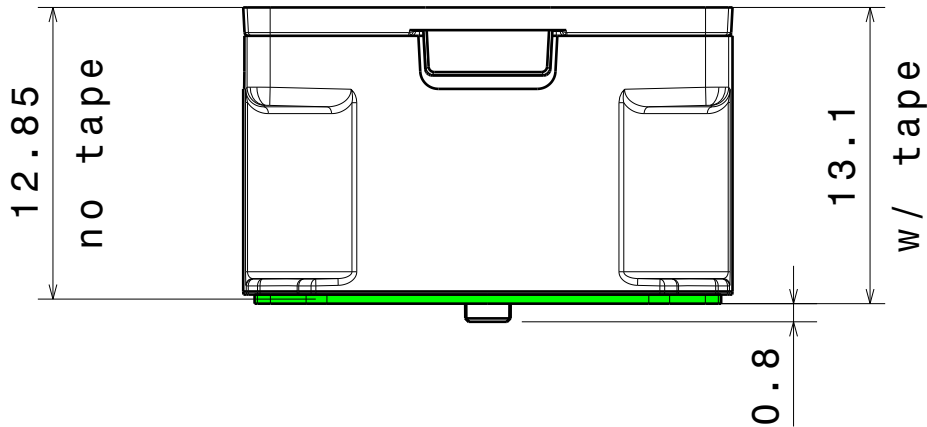

Note: Pinless versions also available

INDEX	DESCRIPTION	MATERIAL	COLOUR
1	LAURA-lens	PMMA	
2	LAURA-XP holder	PC	white/black

Tolerances if not otherwise shown
According to DIN ISO 2768-1
Linear measures:
up to 30mm class M, otherwise class C
According to DIN ISO 2768-2
Form and position: class L

LEDiL

Ledil Oy
Salorankatu 10
FIN 24240 SALO
Finland

THIRD ANGLE PROJECTION:

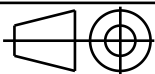

DRAWING TITLE

Laura-XP family datasheet

This drawing is the property
of LEDiL Oy. It may not be
reproduced, copied or
communicated without a written
agreement with LEDiL Oy.

SIZE PART NUMBER

A4

-

SCALE 1:1 WEIGHT

-

SHEET 1/1

D

A

Ledil Oy CA11643_Laura-SS-XP CA11643_Laura-SS-XP / LDC (Linear)

Luminaire: Ledil Oy CA11643_Laura-SS-XP CA11643_Laura-SS-XP
Lamps: 1 x Cree XP-E(white)

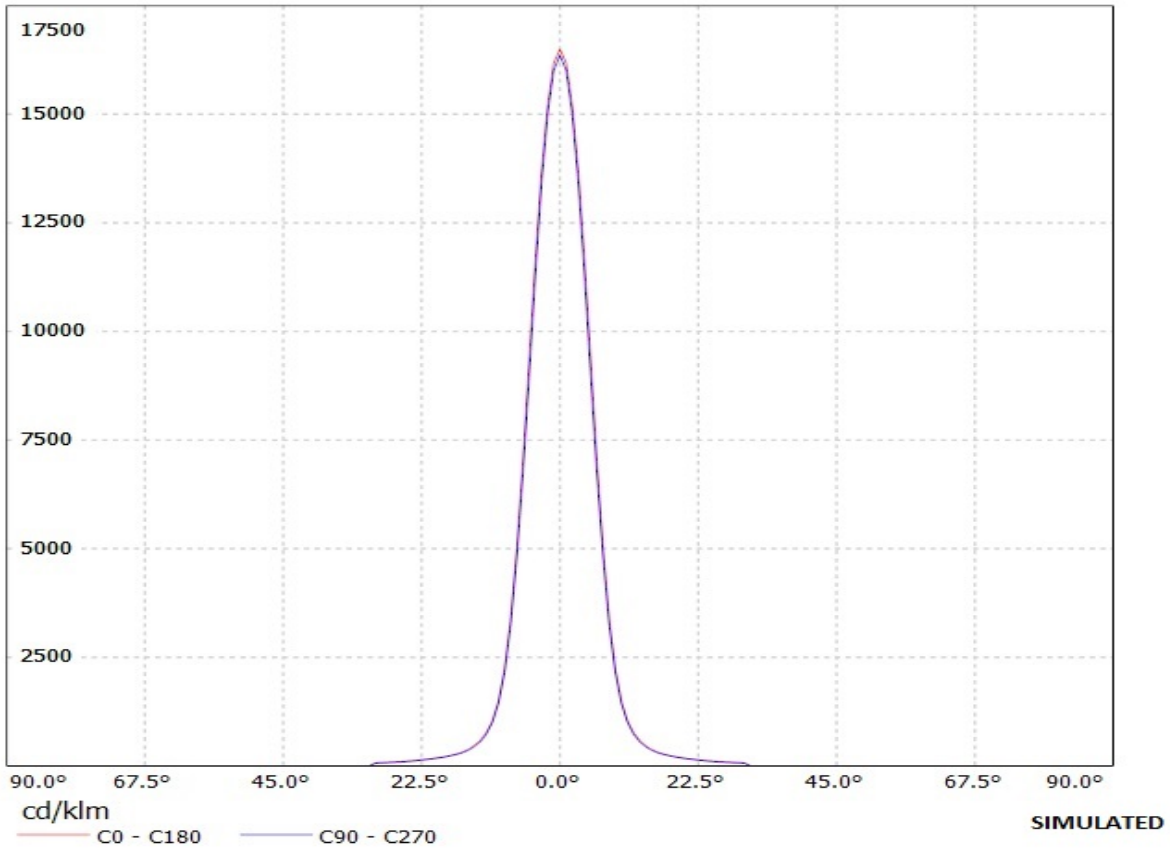

Ledil Oy CA11643_Laura-SS-XP-G-tape / LDC (Linear)

Luminaire: Ledil Oy CA11643_Laura-SS-XP-G-tape
Lamps: 1 x Cree XP-G 63,5lm 250mA Warm

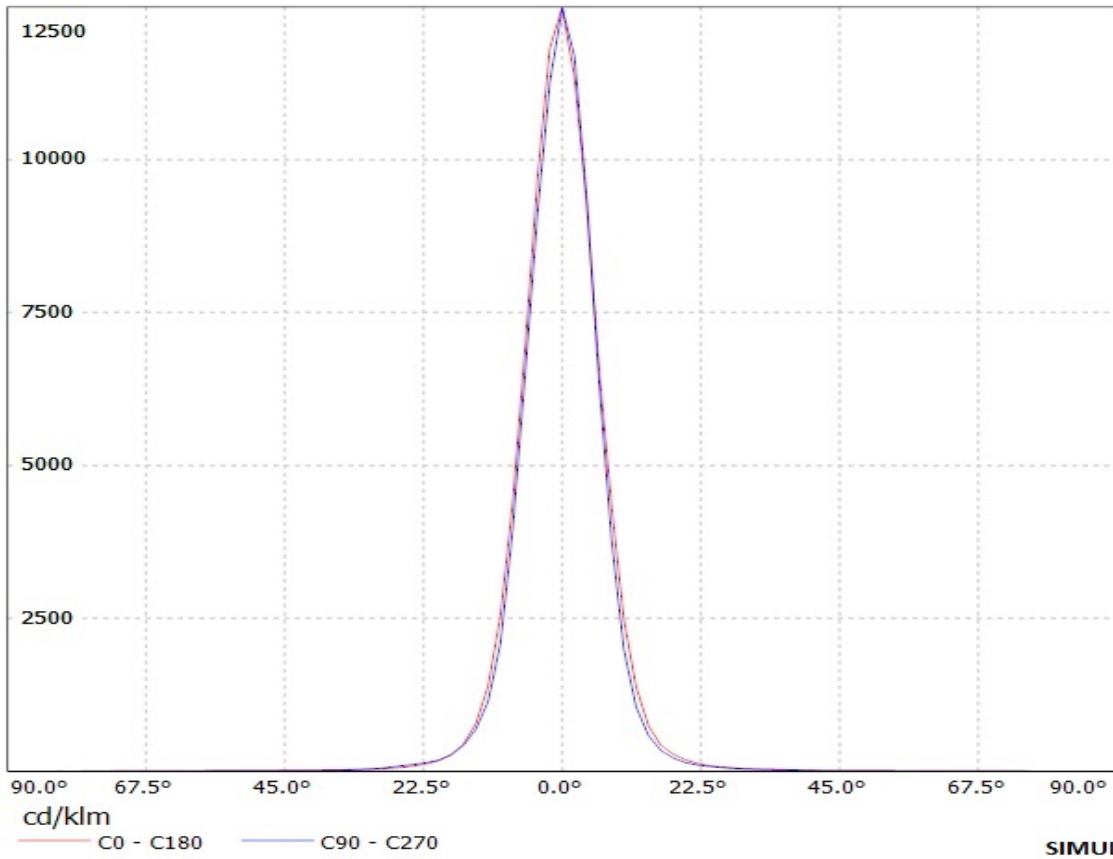

LEDiL Oy CA12011_LAURA-SS-PIN_(LUXEON_T)_1 Eff.92.4% / LDC (Linear)

Luminaire: LEDiL Oy CA12011_LAURA-SS-PIN_(LUXEON_T)_1 Eff.92.4%
Lamps: 1 x LUXEON T (74lm@250mA)

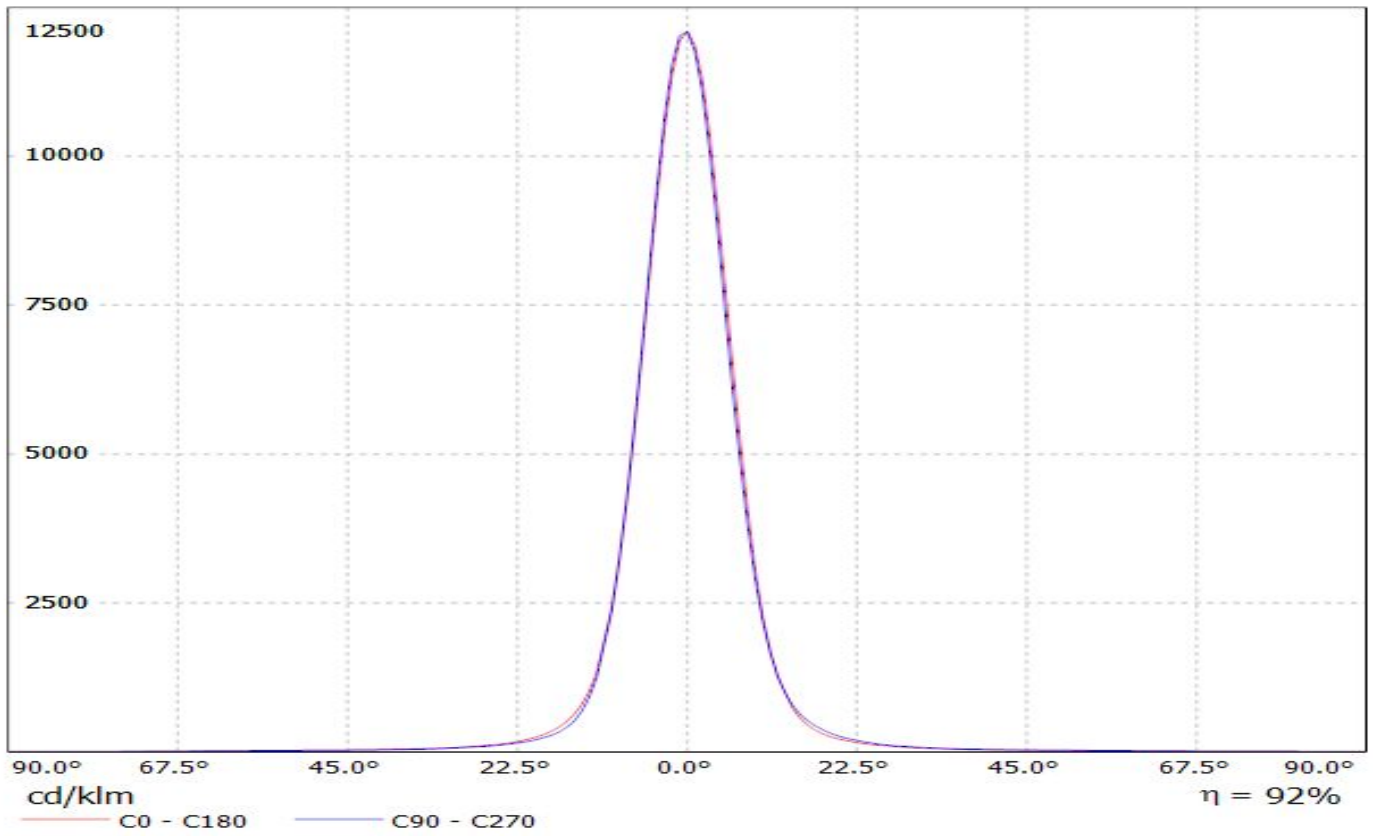

Luminaire: LEDil Oy CA12011_LAURA-SS-PIN_(NCSxx19B) Efficiency=91%
Lamps: 1 x Nichia NCSxx19B (NCSL119BE) 88.5lm @ 250mA CCT=3400K P=0.8W I=250mA

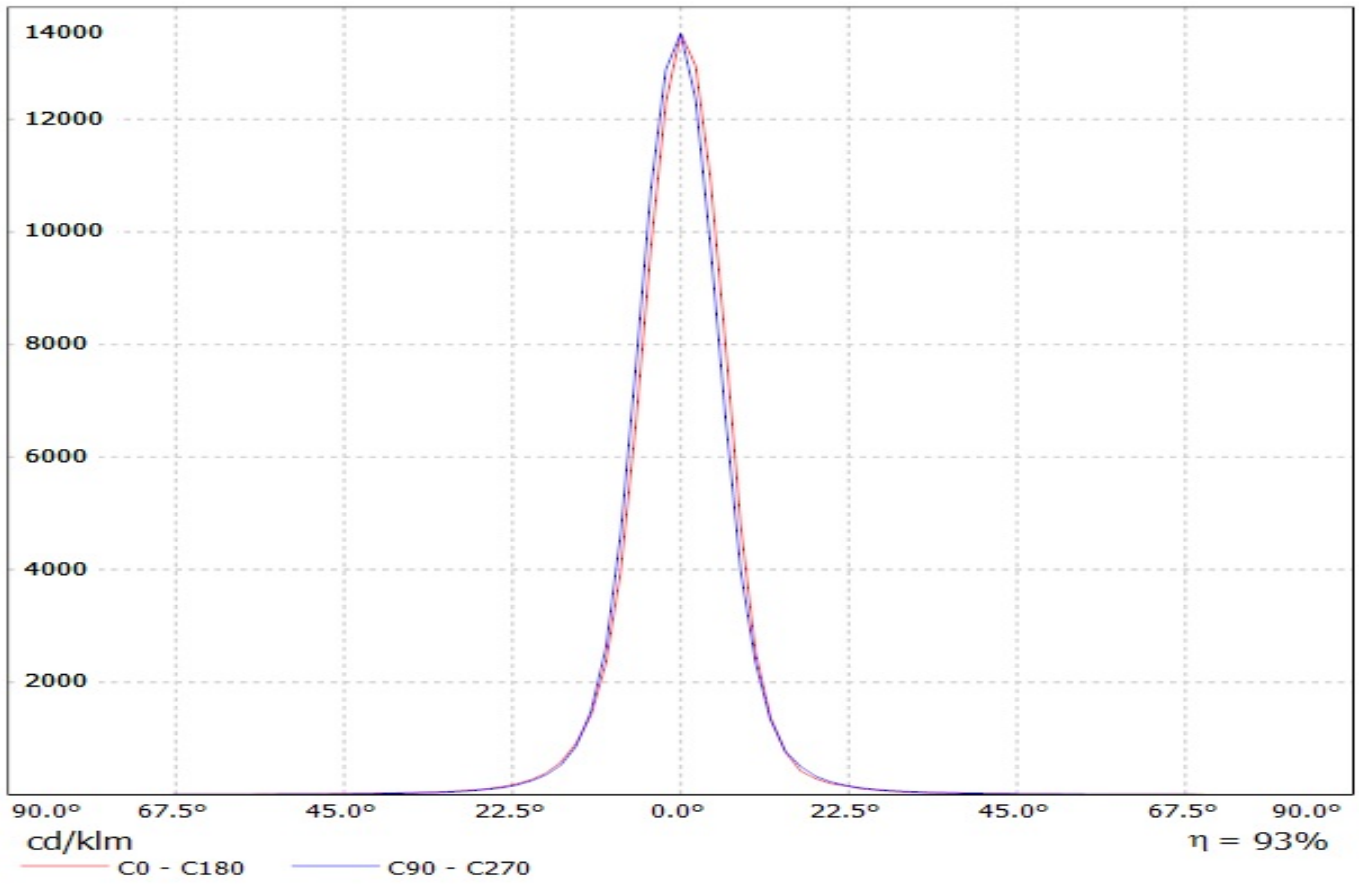

Luminaire: LEDil Oy CA12011_LAURA-SS-PIN_(NF2x757D)

Lamps: 1 x Nichia NF2x757D (NF2W757DRE) 51.43lm @ 65mA CCT=4987K P=0.4W I=65mA

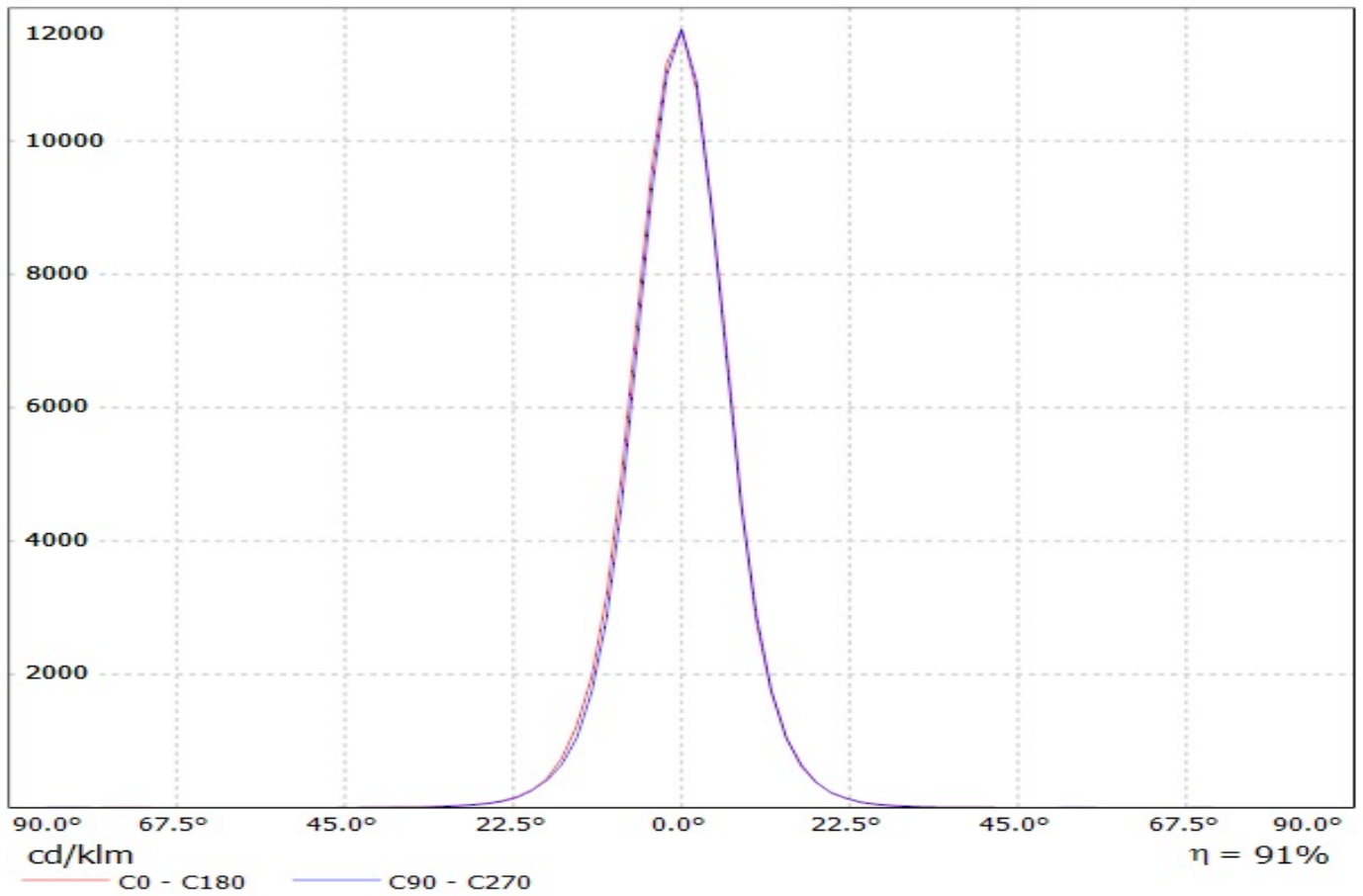

Ledil Oy CA11643_Laura-SS-XP CA11643_Laura-SS-XP / LDC (Polar)

Luminaire: Ledil Oy CA11643_Laura-SS-XP CA11643_Laura-SS-XP

Lamps: 1 x Cree XP-E(white)

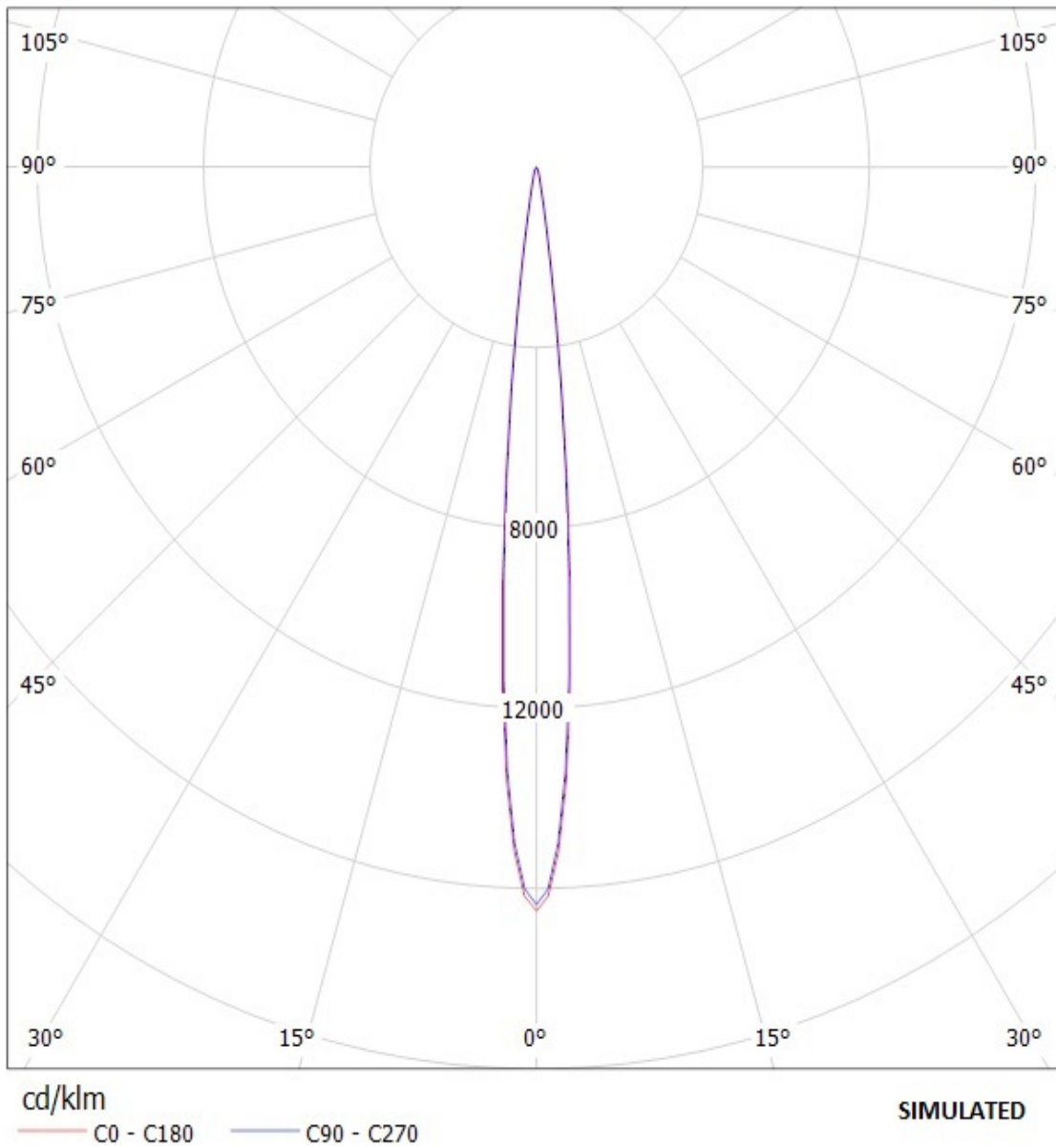

Ledil Oy CA11643_Laura-SS-XP-G-tape / LDC (Polar)

Luminaire: Ledil Oy CA11643_Laura-SS-XP-G-tape

Lamps: 1 x Cree XP-G 63,5lm 250mA Warm

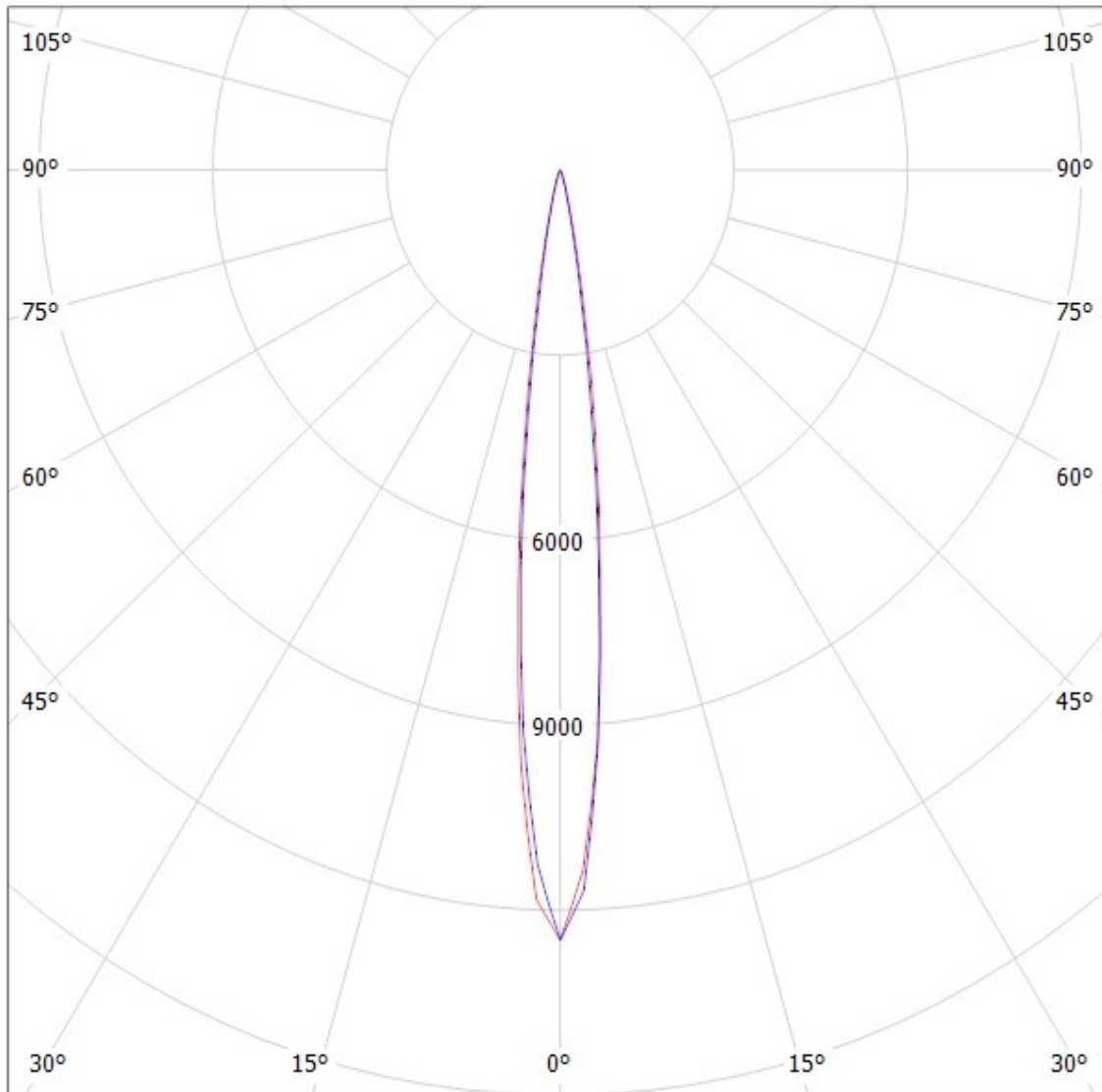

cd/klm

— C0 - C180

— C90 - C270

SIMULATED

LEDiL Oy CA12011_LAURA-SS-PIN_(LUXEON_T)_1 Eff.92.4% / LDC (Polar)

Luminaire: LEDiL Oy CA12011_LAURA-SS-PIN_(LUXEON_T)_1 Eff.92.4%

Lamps: 1 x LUXEON T (74lm@250mA)

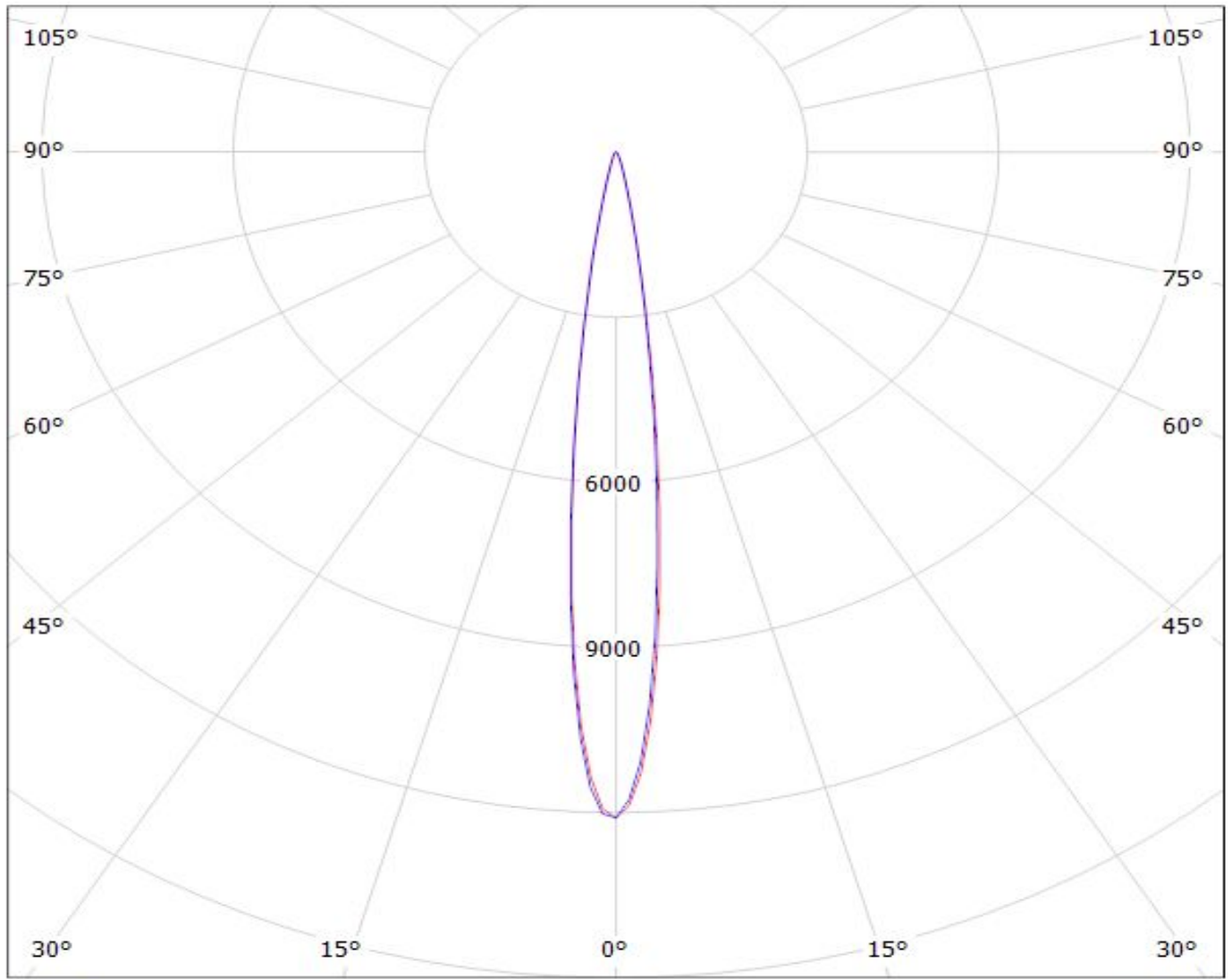

cd/klm

— C0 - C180

— C90 - C270

$\eta = 92\%$

Luminaire: LEDil Oy CA12011_LAURA-SS-PIN_(NCSxx19B) Efficiency=91%
Lamps: 1 x Nichia NCSxx19B (NCSL119BE) 88.5lm @ 250mA CCT=3400K P=0.8W I=250mA

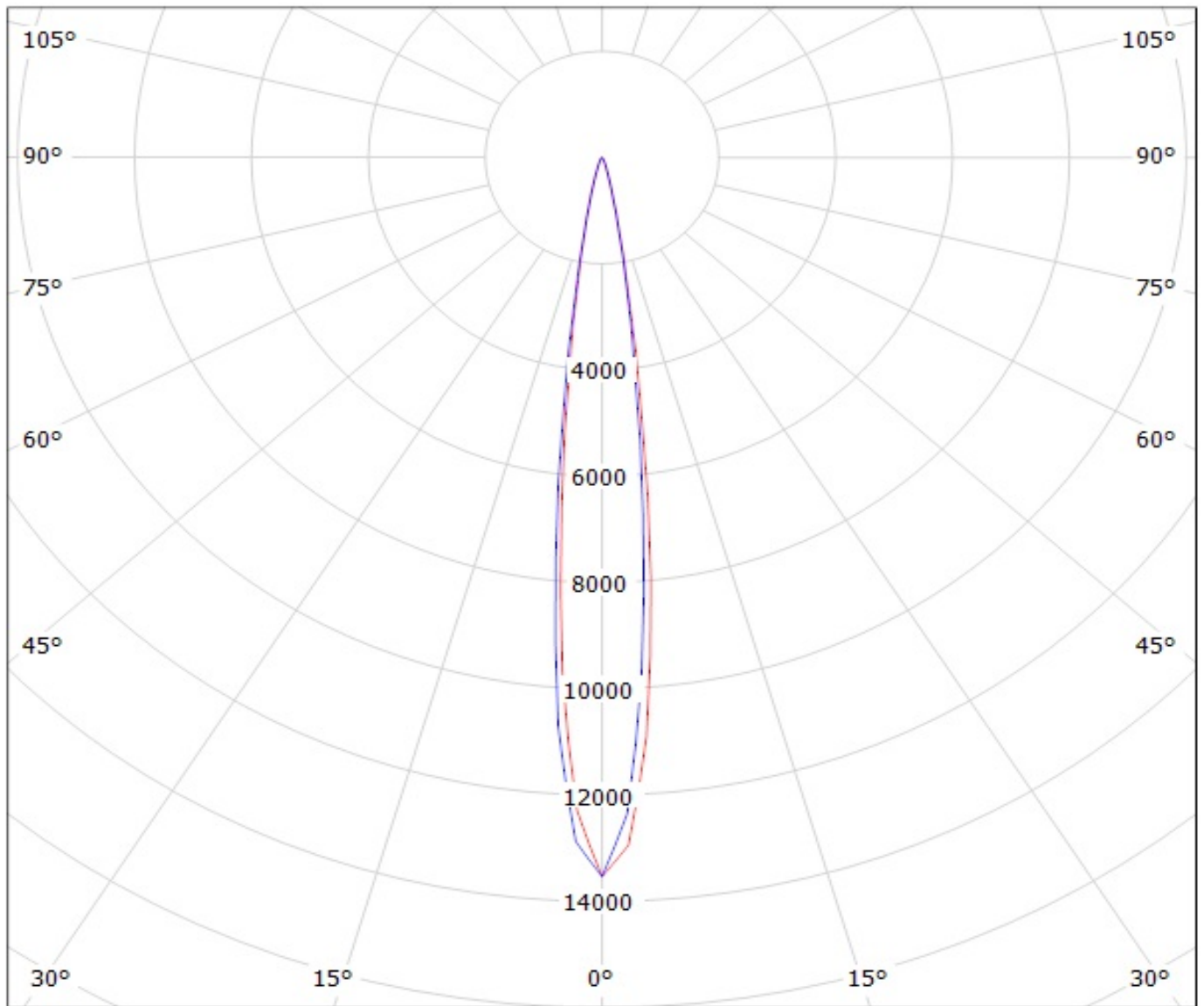

cd/klm

— C0 - C180

— C90 - C270

Luminaire: LEDil Oy CA12011_LAURA-SS-PIN_(NF2x757D)

Lamps: 1 x Nichia NF2x757D (NF2W757DRE) 51.43lm @ 65mA CCT=4987K P=0.4W I=65mA

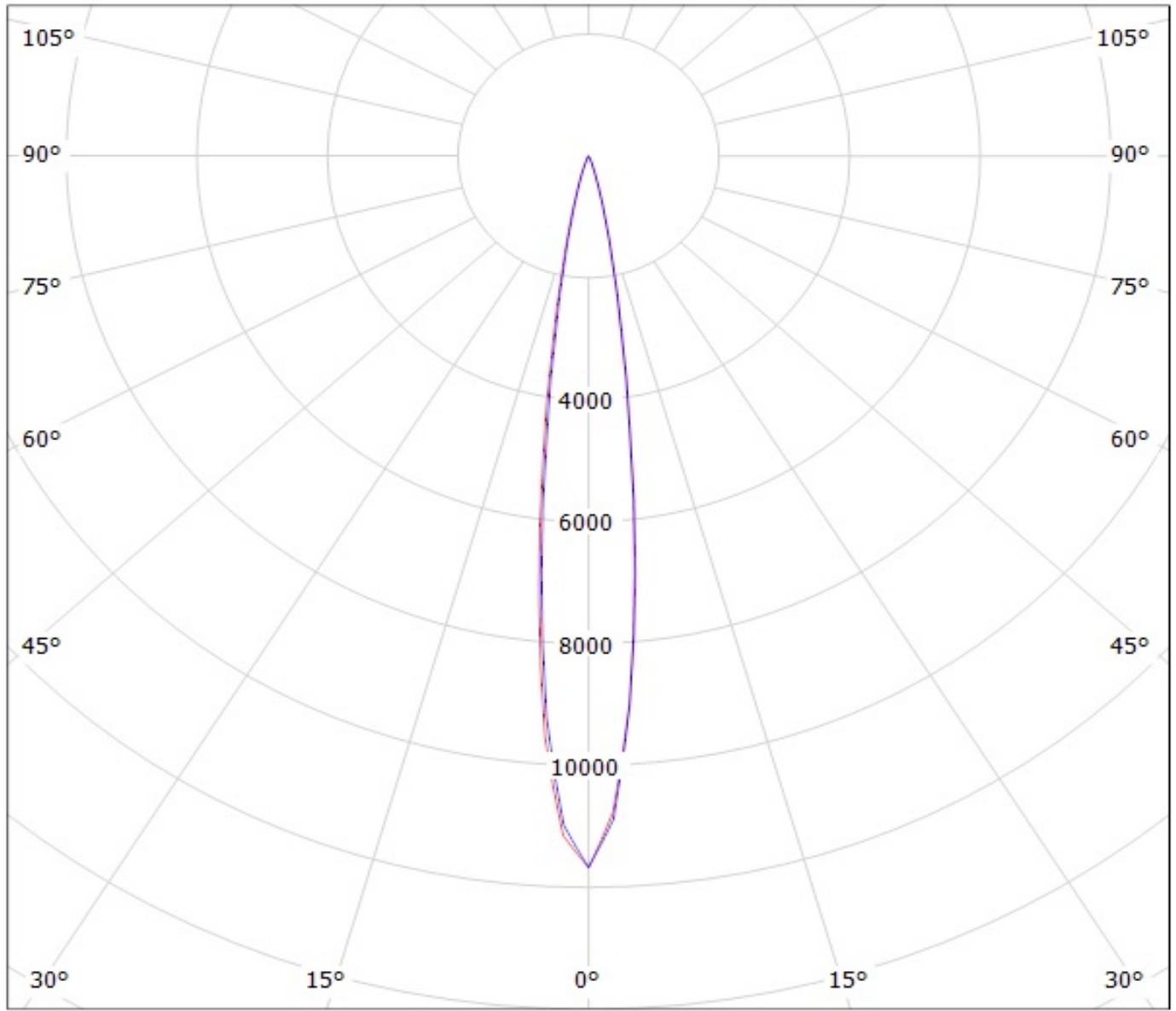

cd/klm

— C0 - C180

— C90 - C270

$\eta = 91\%$

NOTE: The typical divergence will be changed by different color, chip size and chip position tolerance. The typical total divergence is the full angle measured where the luminous intensity is half of the peak value.