



# SAW Components

## SAW Duplexer for Smallcell

Band 1 (3G/LTE)

<b>Series/type:</b>	<b>B8092</b>
<b>Ordering code:</b>	<b>B39212B8092P810</b>
<b>Date:</b>	<b>February 25, 2015</b>
<b>Version:</b>	<b>2.2</b>

© EPCOS AG 2015. Reproduction, publication and dissemination of this publication, enclosures hereto and the information contained therein without EPCOS' prior express consent is prohibited.

EPCOS AG is a TDK Group Company.

**DataSheet**

**Application**

- Low-loss SAW duplexer for 3G/LTE smallcell systems (Band 1)
- Low insertion attenuation
- Low amplitude ripple
- Usable passband 60 MHz
- High power durability
- Industrial qualification
- Rx = uplink = 1920-1980 MHz
- Tx = downlink = 2110-2170 MHz

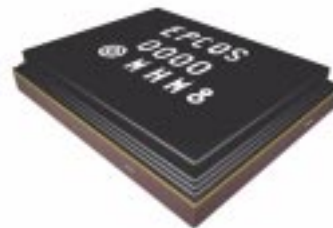
**Features**

- Package size 2.5 \* 2.0 mm<sup>2</sup>
- max. Package height 0.5 mm
- RoHS compatible
- Package for **Surface Mount Technology (SMT)**
- Ni, Au-plated terminals
- **Electrostatic Sensitive Device (ESD)**
- Moisture Sensitivity Level 3

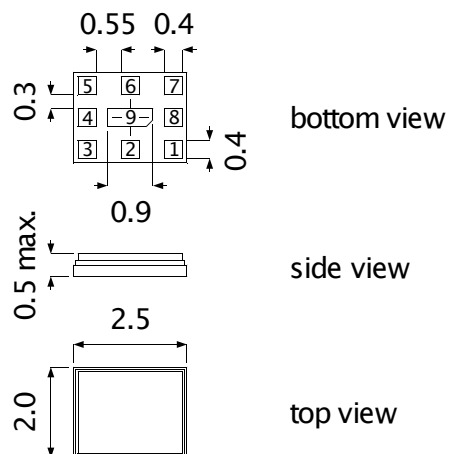
**Pin configuration**

- 3 Rx output
- 1 Tx input
- 6 Antenna
- 2, 4, 5, 7, 8, 9 To be grounded

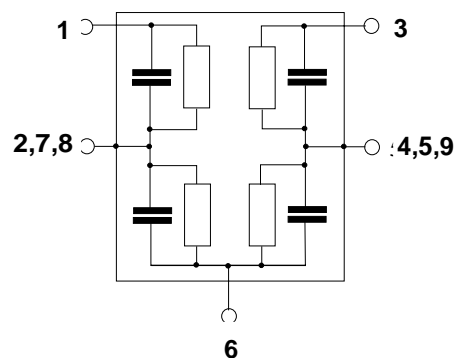

**DataSheet**

**Characteristics**

Temperature range for specification:	T = -10 °C to +85 °C
Antenna terminating impedance:	Z <sub>ANT</sub> = 50 Ω // 2.2 nH
RX terminating impedance:	Z <sub>RX</sub> = 50 Ω
TX terminating impedance:	Z <sub>TX</sub> = 50 Ω

Characteristics TX - ANT		min.	typ. @ 25 °C	max.	
<b>Center frequency</b>	f <sub>C</sub>		2140.0		MHz
<b>Maximum insertion attenuation</b> 2110.0 ... 2170.0 MHz	α <sub>max</sub>	-	2.0	2.5	dB
<b>Amplitude ripple (p-p)</b> 2110.0 ... 2170.0 MHz	Δα	-	0.8	1.6	dB
<b>Error Vector Magnitude</b> 2112.5 ... 2167.5 MHz	EVM <sup>1)</sup>	-	0.5	1.5	%
<b>Input VSWR (TX port)</b> 2110.0 ... 2170.0 MHz		-	1.7	2.0	
<b>Output VSWR (ANT port)</b> 2110.0 ... 2170.0 MHz		-	1.5	2.0	
<b>Attenuation</b>	α				
10.0 ... 1574.0 MHz		30	34	-	dB
843.0 ... 894.0 MHz		30	40	-	dB
1574.0 ... 1606.0 MHz		30	34	-	dB
1606.0 ... 1880.0 MHz		30	34	-	dB
1805.0 ... 1880.0 MHz		30	40	-	dB
1920.0 ... 1980.0 MHz		37	43	-	dB
2250.0 ... 2400.0 MHz		30	48	-	dB
2400.0 ... 2500.0 MHz		30	48	-	dB
2500.0 ... 2700.0 MHz		30	37	-	dB
2700.0 ... 3000.0 MHz		30	37	-	dB
2620.0 ... 2690.0 MHz		30	42	-	dB
3000.0 ... 3800.0 MHz		28	32	-	dB
3800.0 ... 4220.0 MHz		15	20	-	dB
4220.0 ... 4340.0 MHz		10	15	-	dB
4340.0 ... 5000.0 MHz		7	18	-	dB
5000.0 ... 6000.0 MHz		3	7	-	dB

<sup>1)</sup> Error Vector Magnitude (EVM) based on definition given in 3GPP TS 25.141

**DataSheet**

**Characteristics**

Temperature range for specification:	T = -10 °C to +85 °C
Antenna terminating impedance:	Z <sub>ANT</sub> = 50 Ω // 2.2 nH
RX terminating impedance:	Z <sub>RX</sub> = 50 Ω
TX terminating impedance:	Z <sub>TX</sub> = 50 Ω

Characterisitcs ANT - RX		min.	typ. @ 25 °C	max.	
<b>Center frequency</b>	f <sub>C</sub>		1950.0		MHz
<b>Maximum insertion attenuation</b> 1920.0 ... 1980.0 MHz	α <sub>max</sub>	-	2.3	3.7	dB
<b>Amplitude ripple (p-p)</b> 1920.0 ... 1980.0 MHz	Δα	-	0.9	2.2	dB
<b>Error Vector Magnitude</b> 1922.5 ... 1977.5 MHz	EVM <sup>1)</sup>	-	1.5	3.0	%
<b>Input VSWR (ANT port)</b> 1920.0 ... 1980.0 MHz		-	1.9	2.2	
<b>Output VSWR (RX port)</b> 1920.0 ... 1980.0 MHz		-	2.0	2.3	
<b>Attenuation</b>	α				
10.0 ... 1785.0 MHz		30	36	-	dB
1785.0 ... 1880.0 MHz		20	31	-	dB
1880.0 ... 1900.0 MHz		5	15	-	dB
2000.0 ... 2110.0 MHz		2.5	12	-	dB
2110.0 ... 2170.0 MHz		43	48	-	dB
2255.0 ... 2400.0 MHz		30	33	-	dB
2400.0 ... 2500.0 MHz		25	30	-	dB
2500.0 ... 3840.0 MHz		15	20	-	dB
3840.0 ... 3960.0 MHz		20	24	-	dB
3960.0 ... 5000.0 MHz		20	25	-	dB
5000.0 ... 5760.0 MHz		15	30	-	dB
5760.0 ... 5940.0 MHz		15	30	-	dB

<sup>1)</sup> Error Vector Magnitude (EVM) based on definition given in 3GPP TS 25.141

**DataSheet**

**Characteristics**

Temperature range for specification:	T = -10 °C to +85 °C
TX terminating impedance:	Z <sub>Tx</sub> = 50 Ω
ANT terminating impedance:	Z <sub>Ant</sub> = 50 Ω // 2.2 nH
RX terminating impedance:	Z <sub>Rx</sub> = 50 Ω

Characteristics Rx-Tx				min.	typ. @ 25 °C	max.	
<b>Attenuation</b>							
	1920.0 ... 1980.0	MHz	α	42	48	-	dB
	2110.0 ... 2170.0	MHz		47	52	-	dB

**Maximum Ratings**

Storage temperature range	T <sub>stg</sub>	-40/+85	°C	
DC voltage	V <sub>DC</sub>	0	V	
ESD voltage	V <sub>ESD</sub>	50 <sup>1)</sup>	V	
Input power at pin 1				machine model, 1 pulse source and load impedance 50 Ω Pin 28dBm average - 39 dBm peak } LTE 5 MHz downlink T = 55 °C, 100.000 h
2110.0 ...2170.0 MHz	P <sub>in</sub>	28 <sup>2)</sup>	dBm	
elsewhere	P <sub>in</sub>	10	dBm	
Operating lifetime with Output power at antenna				source and load impedance 50 Ω
2110.0 ...2170.0 MHz	P <sub>out</sub>	24 <sup>3)</sup>	dBm	Continuous wave T=55 °C, 100khrs

<sup>1)</sup> According to JESD22-A115A (machine model), 1 negative and 1 positive pulses.

<sup>2)</sup> Time to failure (TTDF) according to accelerated power durability tests, and wear out models.

<sup>3)</sup> according to accelerated High Temperature Operating Life (HTOL) test.

DataSheet



**Frequency Response TX-ANT**

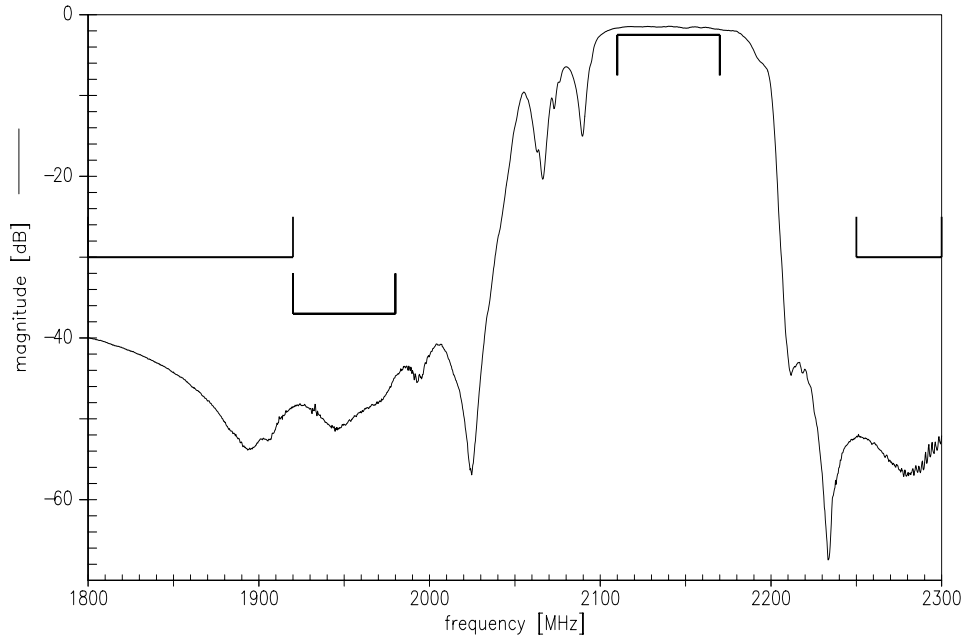

**Frequency Response TX-ANT**

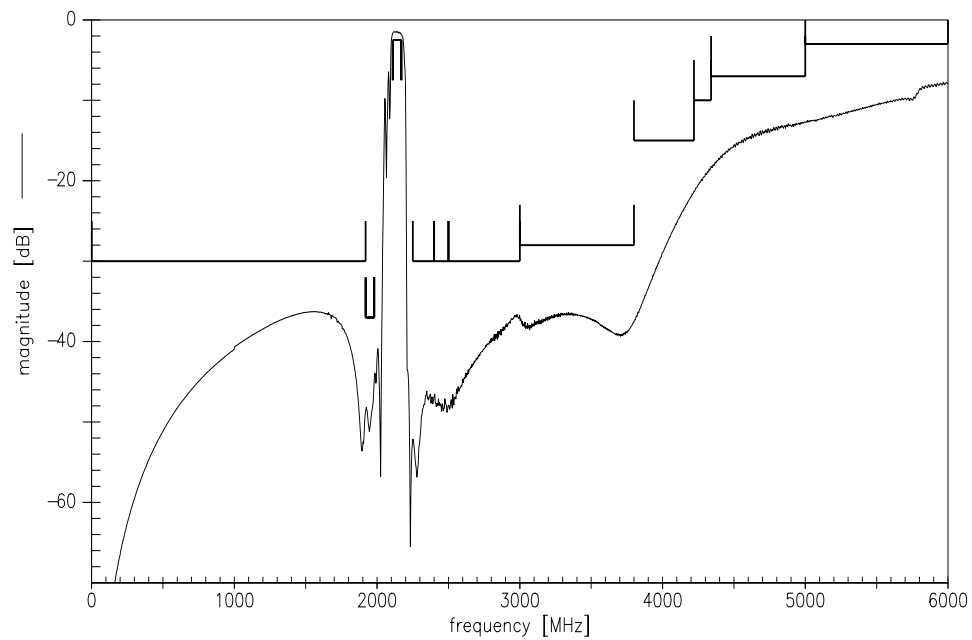

Please read *cautions and warnings* and *important notes* at the end of this document.



Frequency Response ANT-RX

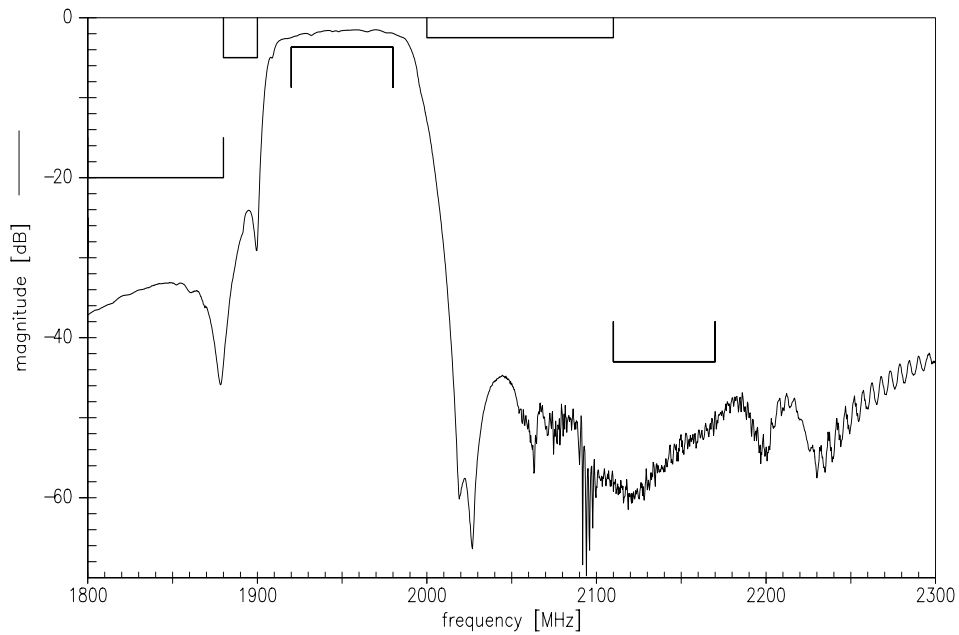

Frequency Response ANT-RX

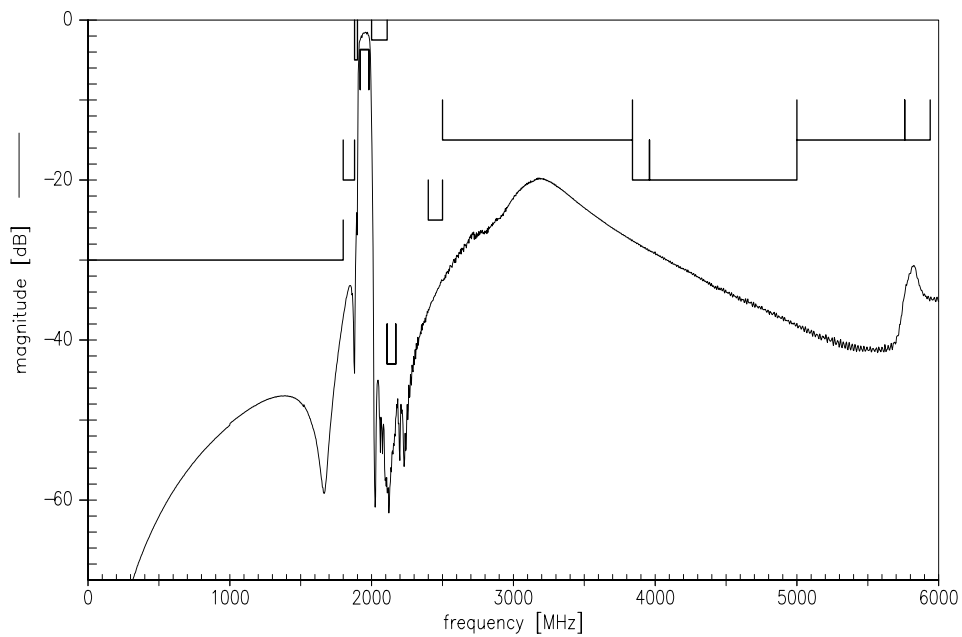



**Frequency Response TX-RX**

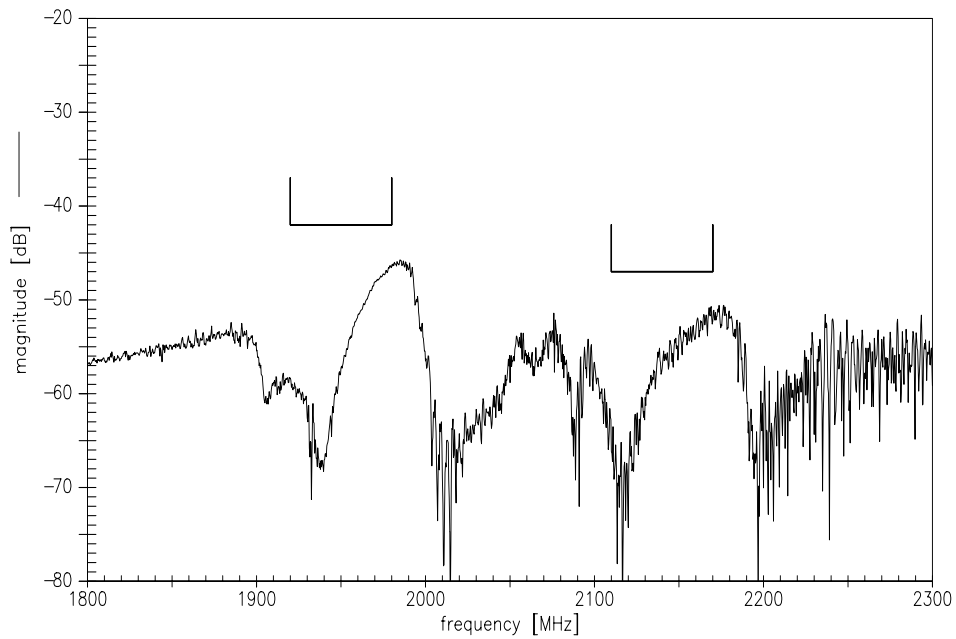

**Frequency Response TX-RX**

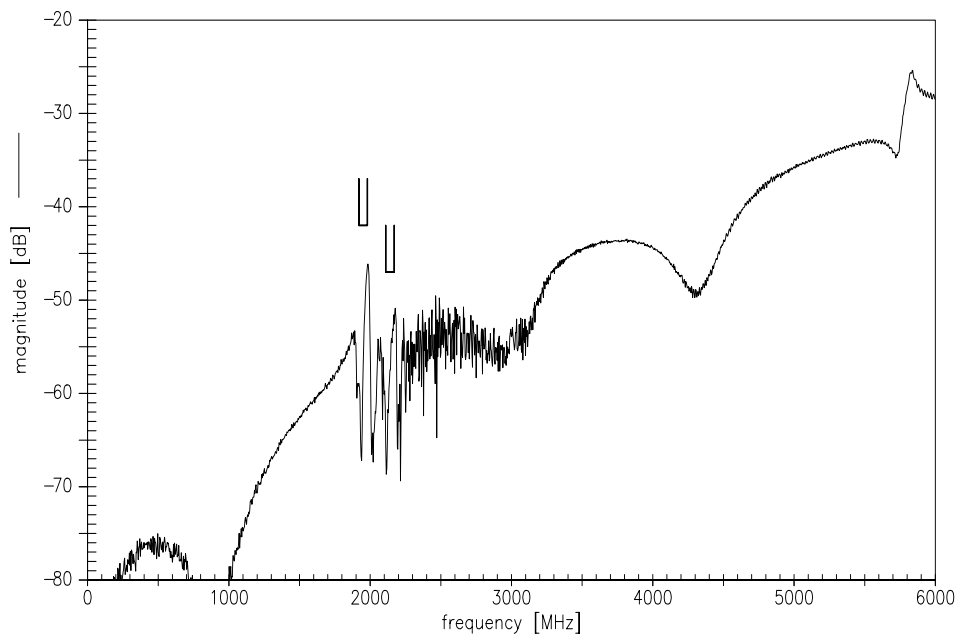

Please read *cautions and warnings* and *important notes* at the end of this document.



**DataSheet**



**S11 VSWR (TX)**

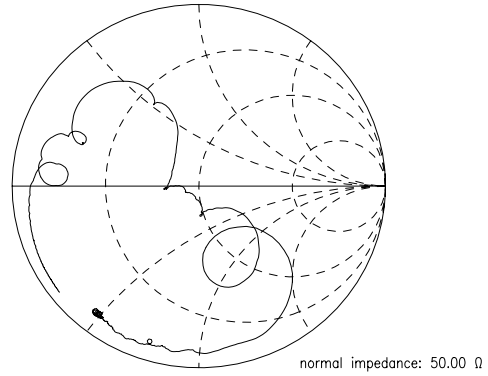
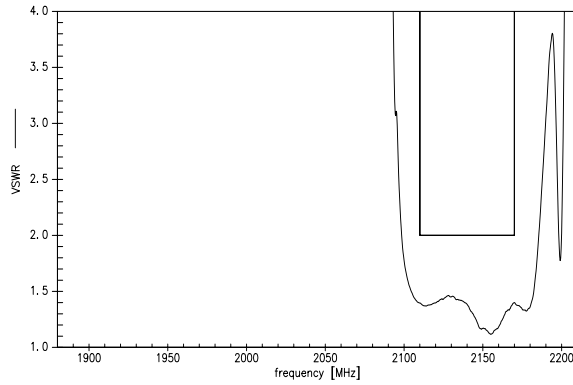

**S22 VSWR (ANT)**

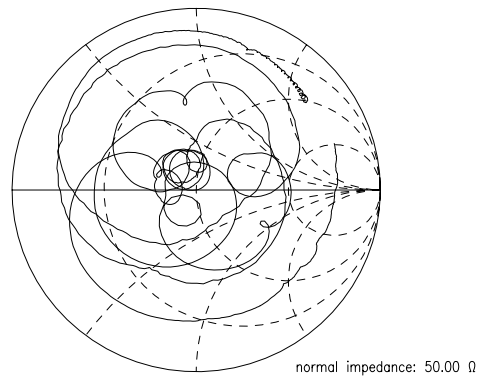
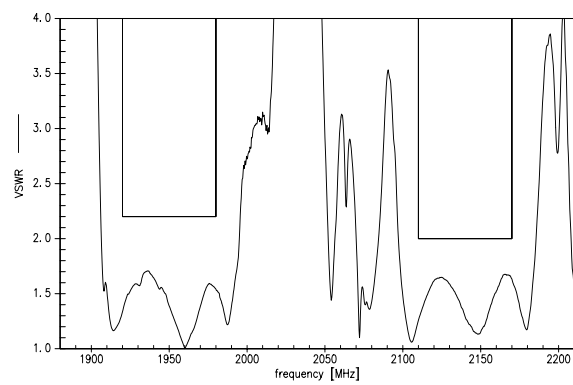

**S33 VSWR (RX)**

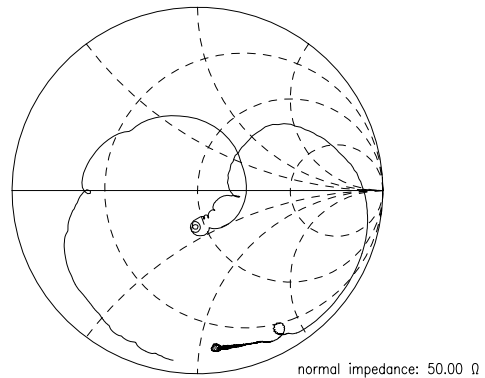
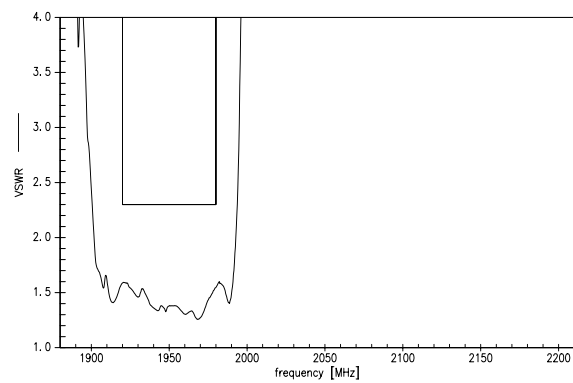

DataSheet



**EVM Rx**

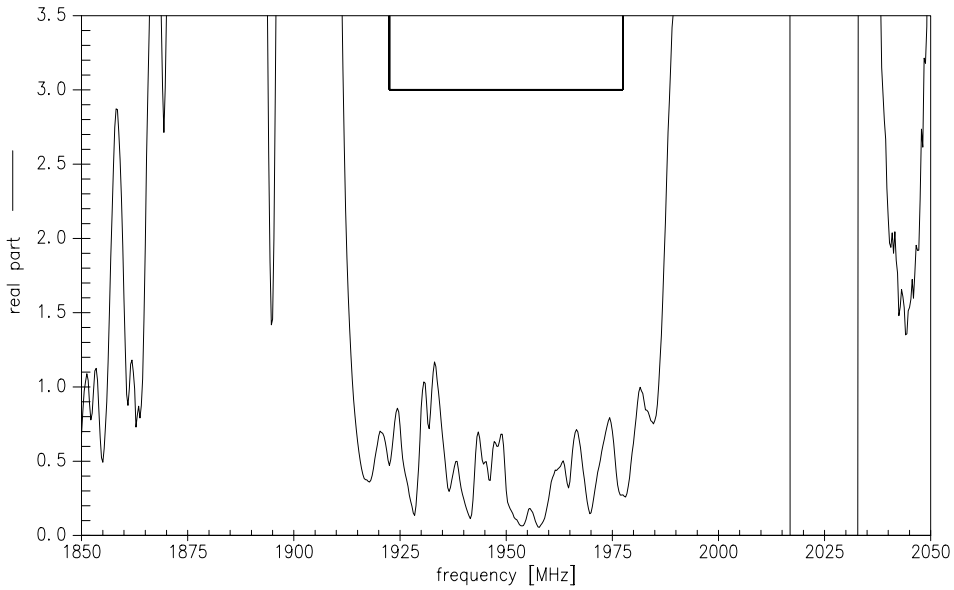

**EVM Tx**

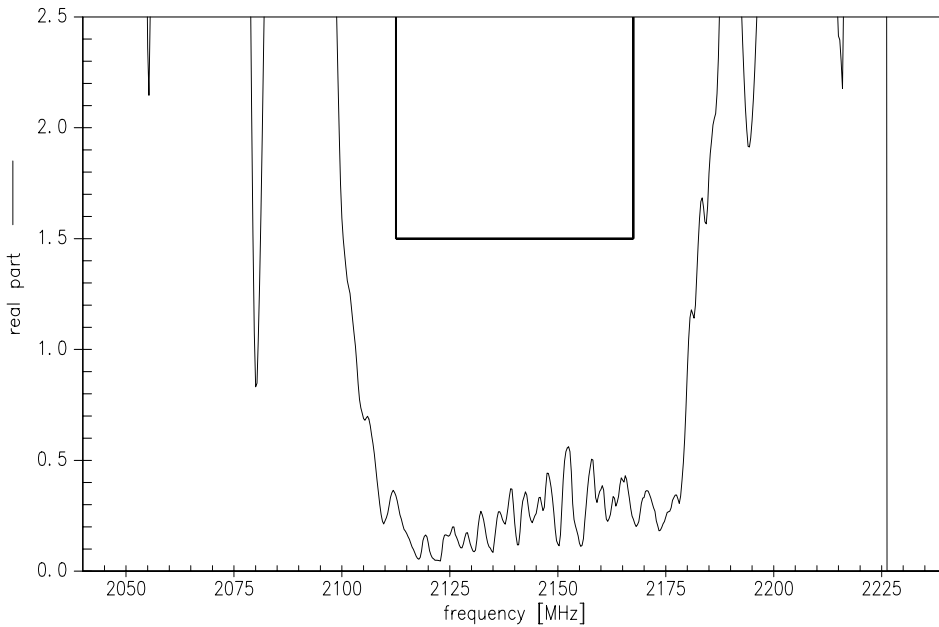

DataSheet



References

<b>Type</b>	B8092
<b>Ordering code</b>	B39212B8092P810
<b>Marking and package</b>	C61157-A8-A61
<b>Packaging</b>	F61074-V8232-Z000
<b>Date codes</b>	L_1126
<b>S-parameters</b>	B8092_NB.s3p, B8092_WB.s3p see file header for port/pin assignement table
<b>Soldering profile</b>	S_6001
<b>RoHS compatible</b>	RoHS-compatible means that products are compatible with the requirements according to Art. 4 (substance restrictions) of Directive 2011/65/EU of the European Parliament and of the Council of June 8 <sup>th</sup> , 2011, on the restriction of the use of certain hazardous substances in electrical and electronic equipment ("Directive") with due regard to the application of exemptions as per Annex III of the Directive in certain cases.
<b>Moldability</b>	Before using in overmolding environment, please contact your EPCOS sales office.
<b>Matching coils</b>	See Inductor pdf-catalog <a href="http://www.tdk.co.jp/tefe02/coil.htm#aname1">http://www.tdk.co.jp/tefe02/coil.htm#aname1</a> and Data Library for circuit simulation <a href="http://www.tdk.co.jp/etvcl/index.htm">http://www.tdk.co.jp/etvcl/index.htm</a>

For further information please contact your local EPCOS sales office or visit our webpage at [www.epcos.com](http://www.epcos.com).

**Published by EPCOS AG**  
**Systems, Acoustics, Waves Business Group**  
**P.O. Box 80 17 09, 81617 Munich, GERMANY**

© EPCOS AG 2015. This brochure replaces the previous edition.

For questions on technology, prices and delivery please contact the Sales Offices of EPCOS AG or the international Representatives.

Due to technical requirements components may contain dangerous substances. For information on the type in question please also contact one of our Sales Offices.

## Important notes

The following applies to all products named in this publication:

1. Some parts of this publication contain **statements about the suitability of our products for certain areas of application**. These statements are based on our knowledge of typical requirements that are often placed on our products in the areas of application concerned. We nevertheless expressly point out **that such statements cannot be regarded as binding statements about the suitability of our products for a particular customer application**. As a rule, EPCOS is either unfamiliar with individual customer applications or less familiar with them than the customers themselves. For these reasons, it is always ultimately incumbent on the customer to check and decide whether an EPCOS product with the properties described in the product specification is suitable for use in a particular customer application.
2. We also point out that **in individual cases, a malfunction of electronic components or failure before the end of their usual service life cannot be completely ruled out in the current state of the art, even if they are operated as specified**. In customer applications requiring a very high level of operational safety and especially in customer applications in which the malfunction or failure of an electronic component could endanger human life or health (e.g. in accident prevention or life-saving systems), it must therefore be ensured by means of suitable design of the customer application or other action taken by the customer (e.g. installation of protective circuitry or redundancy) that no injury or damage is sustained by third parties in the event of malfunction or failure of an electronic component.
3. **The warnings, cautions and product-specific notes must be observed.**
4. In order to satisfy certain technical requirements, **some of the products described in this publication may contain substances subject to restrictions in certain jurisdictions (e.g. because they are classed as hazardous)**. Useful information on this will be found in our Material Data Sheets on the Internet ([www.epcos.com/material](http://www.epcos.com/material)). Should you have any more detailed questions, please contact our sales offices.
5. We constantly strive to improve our products. Consequently, **the products described in this publication may change from time to time**. The same is true of the corresponding product specifications. Please check therefore to what extent product descriptions and specifications contained in this publication are still applicable before or when you place an order. We also **reserve the right to discontinue production and delivery of products**. Consequently, we cannot guarantee that all products named in this publication will always be available. The aforementioned does not apply in the case of individual agreements deviating from the foregoing for customer-specific products.
6. Unless otherwise agreed in individual contracts, **all orders are subject to the current version of the "General Terms of Delivery for Products and Services in the Electrical Industry" published by the German Electrical and Electronics Industry Association (ZVEI)**.
7. The trade names EPCOS, Alu-X, CeraDiode, CeraLink, CeraPad, CeraPlas, CSMP, CSSP, CTVS, DeltaCap, DigiSiMic, DSSP, ExoCore, FilterCap, FormFit, LeaXield, MiniBlue, MiniCell, MKD, MKK, MotorCap, PCC, PhaseCap, PhaseCube, PhaseMod, PhiCap, PQSine, SIFERRIT, SIFI, SIKOREL, SilverCap, SIMDAD, SiMic, SIMID, SineFormer, SIOV, SIP5D, SIP5K, TFAP, ThermoFuse, WindCap are **trademarks registered or pending** in Europe and in other countries. Further information will be found on the Internet at [www.epcos.com/trademarks](http://www.epcos.com/trademarks).