



ON Semiconductor®

FAN7085-GF085 High Side Gate Driver with Recharge FET

Features

- Qualified to AEC Q100
- Floating channel designed for bootstrap operation fully operational up to 300V.
- Tolerance to negative transient voltage on VS pin
- dv/dt immune.
- Gate drive supply range from 4.5V to 20V
- Under-voltage lockout
- CMOS Schmitt-triggered inputs with pull-down and pull-up
- High side output out of phase with input (Inverted input)
- Reset input
- Internal recharge FET for bootstrap refresh

Typical Applications

- Diesel and gasoline injectors/valves
- MOSFET-and IGBT high side driver applications



Description

The FAN7085-GF085 is a high-side gate drive IC with reset input and built-in recharge FET. It is designed for high voltage and high speed driving of MOSFET or IGBT, which operates up to 300V. ON Semiconductor's high-voltage process and common-mode noise cancellation technique provide stable operation in the high side driver under high-dV/dt noise circumstances. Logic input is compatible with standard CMOS outputs. The UVLO circuits prevent from malfunction when VCC and VBS are lower than the specified threshold voltage. It is available with space saving SOIC-8 Package. Minimum source and sink current capability of output driver is 250mA and 250mA. Built-in recharge FET to refresh bootstrap circuit is very useful for circuit topology requiring switches on low and high side of load.

SOIC-8



Ordering Information

Device	Package	Operating Temp.
FAN7085M-GF085	SOIC-8	-40 °C ~ 125 °C
FAN7085MX-GF085	SOIC-8	-40 °C ~ 125 °C

X : Tape & Reel type

FAN7085-GF085 High Side Gate Driver with Recharge FET

Absolute Maximum Ratings

Absolute Maximum Ratings indicate sustained limits beyond which damage to the device may occur. All voltage parameters are absolute voltages referenced to GND.

Parameter	Symbol	Min.	Max.	Unit
High side floating supply voltage	VBS	-0.3	25	V
High side driver output stage voltage Neg. transient: 0.5 ms, external MOSFET off	VB	-5	325	V
High side floating supply offset voltage Neg. transient 0.2 us	Vs	-25	300	V
High side floating output voltage	VHO	VS-0.3	VB+0.3	V
Supply voltage	VCC	-0.3	25	V
Input voltage for IN-	VIN	-0.3	Vcc+0.3	V
Input voltage for RESET-	VRES	-0.3	Vcc+0.3	V
Power Dissipation ¹⁾	Pd		0.625	W
Thermal resistance, junction to ambient ¹⁾	Rthja		200	°C/W
Electrostatic discharge voltage (Human Body Model)	V _{ESD}	1.5K		V
Charge device model	V _{CDM}	500		V
Junction Temperature	T _j		150	°C
Storage Temperature	T _s	-55	150	°C

Note: 1) The thermal resistance and power dissipation rating are measured below conditions;

JESD51-2: Integrated Circuit Thermal Test Method Environmental Conditions - Natural condition(StillAir)

JESD51-3: Low Effective Thermal Conductivity Test Board for Leaded Surface Mount Package

Recommended Operating Conditions

For proper operation the device should be used within the recommended conditions. -40°C ≤ Ta ≤ 125°C

Parameter	Symbol	Min.	Max.	Unit
High side floating supply voltage(DC) Transient:-10V@ 0.2 us	VB	VS+4.5	VS+20	V
High side floating supply offset voltage(DC) @VBS=7V	VS	-3	300	V
High side floating supply offset voltage(Transient) 0.2us @VBS<25V	VS	-25	300	V
High side floating output voltage	VHO	Vs	VB	V
Allowable offset voltage Slew Rate ¹⁾	dv/dt	-	50	V/ns
Supply voltage for logic part	VCC	4.5	20	V
Input voltage for IN-	VIN	0	Vcc	V
Input voltage for RESET-	VRESET	0	Vcc	V
Switching frequency ²⁾	Fs		200K	Hz
Minimum low input width ³⁾	tIN(low,min)	560	-	ns
Minimum high input width ³⁾	tIN(high,min)	60	-	ns
Minimum operating voltage of VB related to GND	VB(MIN) ⁴⁾	4	-	V
Ambient temperature	Ta	-40	125	°C

Note: 1) Guaranteed by design.

2) Duty = 0.5, VBS ≥ 7V

3) Guaranteed by design. Pulse widths below the specified values, may be ignored. Output will either follow the input signal or will ignore it.

No false output state is guaranteed when minimum input width is smaller than tin

4) Guaranteed by design

Statics Electrical Characteristics

Unless otherwise specified, $-40^{\circ}\text{C} \leq T_a \leq 125^{\circ}\text{C}$, $V_{CC} = 5\text{V}$, $V_{BS} = 7\text{V}$, $V_S = 0\text{V}$, $V_{RESET} = 5\text{V}$, $R_L = 50\Omega$, $C_L = 2.5\text{nF}$.

Parameter	Symbol	Conditions	Min.	Typ.	Max.	Unit
VCC and VBS Supply Characteristics						
VCC and VBS supply under voltage positive going threshold	VCCUV+ VBSUV+	VCC and VBS rising from 0V	-	3.7	4.3	V
VCC and VBS supply under voltage negative going threshold	VCCUV- VBSUV-	VCC and VBS dropping from 5V	2.8	3.4	-	V
VCC and VBS under voltage hysteresis	VCCUVH VBSUVH	-	0.02	0.3	-	V
Under voltage lockout response time	tduvcc tduvbs	VCC: 6.5V->2.4V or 2.4V->6.5V VBS: 6.5V->2.4V or 2.4V->6.5V	0.5 0.5		20 20	us us
Offset supply leakage current	ILK	VB=VS=300V	-	-	200	uA
Quiescent Vcc supply current	IQCC	Vcc=20V	-	-	500	uA
Quiescent VBS supply current	IQBS1	Static mode, VBS=7V, VIN=0 or 5V			100	uA
Quiescent VBS supply current	IQBS2	Static mode, VBS=16V, VIN=0 or 5V			200	uA
VBS drop due to output turn-on (Design guaranty)	ΔV_{BS}	VBS=7V, Cbs=1uF, tdiG-IN=3uS, tTEST=100uS			210	mV
Input Characteristics						
High logic level input voltage for IN-	VIH		0.6VCC	-	-	V
Low logic level input voltage for IN-	VIL		-	-	0.28VCC	V
Low logic level input bias current for IN-	IIN-	VIN=0	5	25	60	uA
High logic level input bias current for IN-	IIN+	VIN=5V	-	-	5	uA
Full up resistance at IN	RIN		83	200	1000	K Ω
High logic level input voltage for RESET-	VRH		0.6Vcc	-	-	V
Low logic level input voltage for RESET-	VRL				0.28Vcc	V
High logic level input current for RESET-	IRES+	VRESET=5V	5	25	60	uA
Low logic level input bias current for RESET-	IRES-	VRESET=0			5	uA
Full down resistance at RESET-	RRES		83	200	1000	K Ω
Output characteristics						
High level output voltage, VB - VHO	VOH	IO=0	-	-	0.1	V
Low level output voltage, VHO-GND	VOL	IO=0	-	-	0.1	V
Peak output source current	IO+	VIN=5V	250	450	-	mA
Peak output sink current	IO-	VIN=0	250	450	-	mA
Equivalent output resistance	ROP			15.5	28	Ω
	RON			15.5	28	Ω
Recharge Characteristics						
Recharge TR turn-on propagation delay	Ton_rech		4	7.9	9.8	us
Recharge TR turn-off propagation delay	Toff_rech			0.2	0.4	us
Recharge TR on-state voltage drop	VRECH	Is=1mA, VIN=5V @125°C			1.2	V
Dead Time Characteristics						
High side turn-off to recharge gate turn-on	DTHOFF	VCC=5V, VS=7V	4	7.8	9.8	us
Recharge gate turn-off to high side turn-on	DTHON	VCC=5V, VS=7V	0.1	0.4	0.7	us

Note: The input parameter are referenced to GND. The VO and IO parameters are referenced to GND.

Dynamic Electrical Characteristics

Unless otherwise specified, $-40^{\circ}\text{C} \leq T_a \leq 125^{\circ}\text{C}$, $V_{CC} = 5\text{V}$, $V_{BS} = 7\text{V}$, $V_S = 0\text{V}$, $V_{RESET} = 5\text{V}$, $R_L = 50\Omega$, $C_L = 2.5\text{nF}$.

Parameter	Symbol	Conditions	Min.	Typ.	Max.	Unit
Input-to-output turn-on propagation delay	t _{plh}	50% input level to 10% output level, V _S = 0V		0.56	1	us
Input-to-output turn-off propagation delay	t _{phl}	50% input level to 90% output level V _S = 0V	-	0.15	0.5	us
RESET-to-output turn-off propagation delay	t _{phl_res}	50% input level to 90% output level	-	0.17	0.5	us
RESET-to-output turn-on propagation delay	t _{plh_res}	50% input level to 10% output level	-	0.56	1	us
Output rising time	tr1	T _j =25°C	-	65	200	ns
	tr2			-	400	ns
	tr3	T _j =25°C, V _{BS} =16V		65	200	ns
	tr4	V _{BS} =16V		-	400	ns
Output falling time	tf1	T _j =25°C	-	25	200	ns
	tf2			-	300	ns
	tf3	T _j =25°C, V _{BS} =16V		25	200	ns
	tf4	V _{BS} =16V		-	300	ns

Application Information

1. Logic Tables

VCC	VBS	RESET-	IN-	Ho	RechFET
< VCCUVLO-	X	X	X	OFF	ON
X	X	LOW	X	OFF	ON
X	X	X	HIGH	OFF	ON
> VCCUVLO+	> VBSUVLO+	HIGH	LOW	ON	OFF
> VCCUVLO+	< VBSUVLO-	HIGH	LOW	OFF	OFF

Notes:

X means independent from signal

IN=LOW indicates that the high side NMOS is ON

IN=HIGH indicates that the high side NMOS is OFF

RechFET =ON indicates that the recharge MOSFET is ON

RechFET =OFF indicates that the recharge MOSFET is OFF

Typical Application Circuit

1. Typical Application Circuit

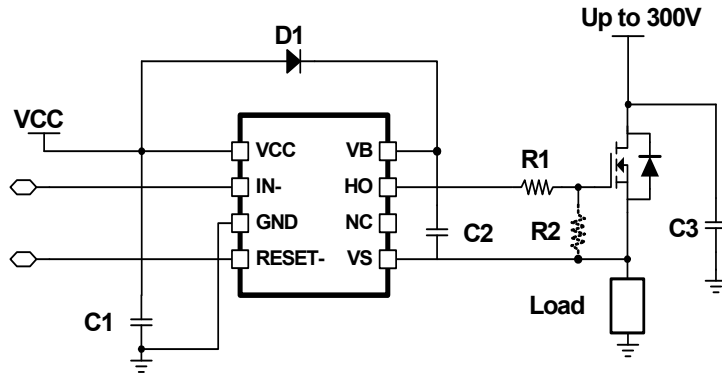

2. Application Example

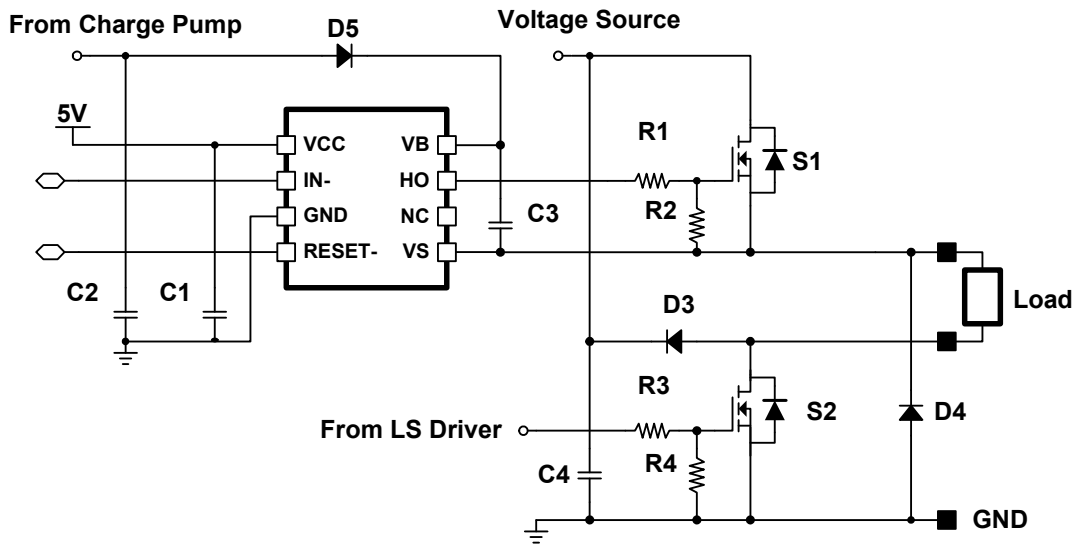

Input-Output Waveforms

1. Input/Output Timing Diagrams

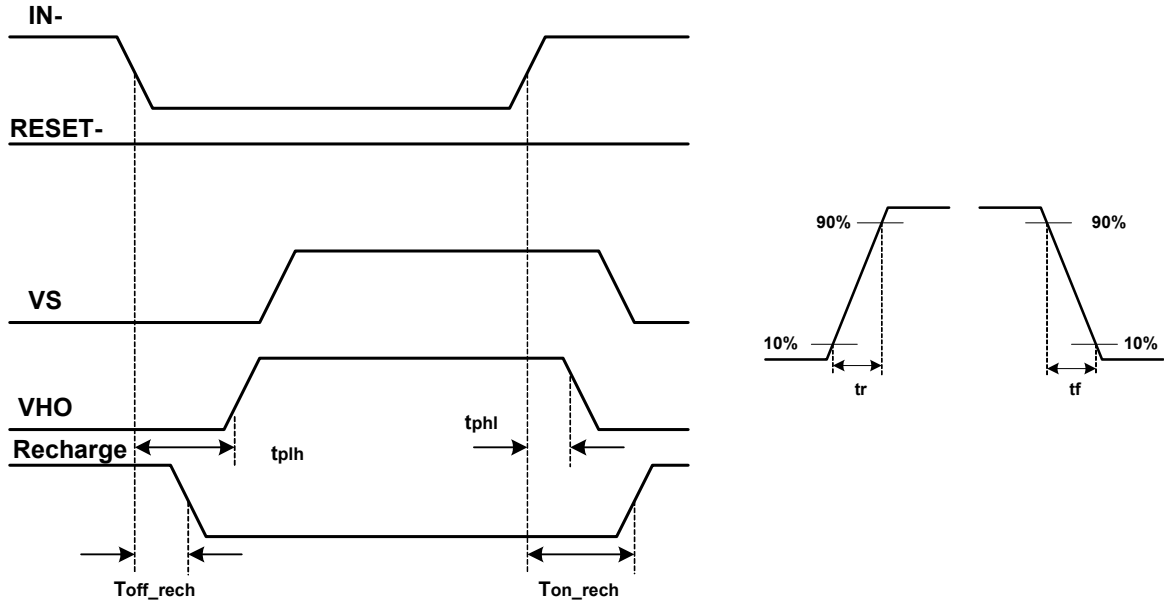

Figure.1 Input and Output Timing Diagram and Switching Time Waveform Definition

2. Reset Timing Diagrams

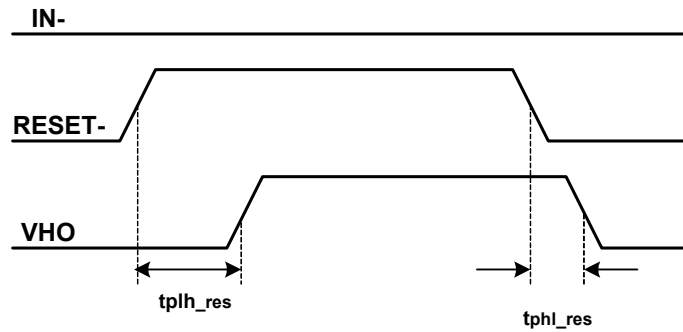

Figure.2 Reset and Output Timing Diagram

3.VB Drop Voltage Diagram

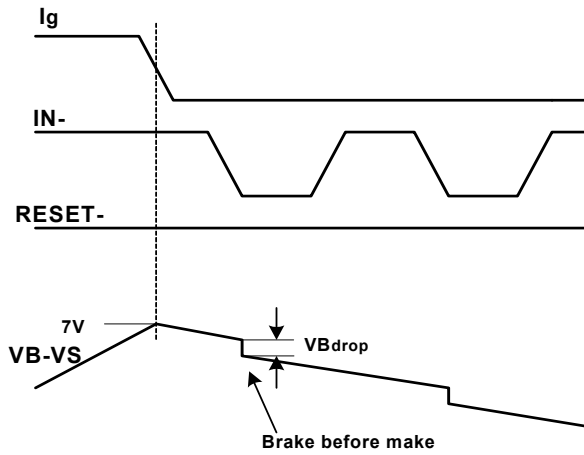

Figure3.a VB Drop Voltage Diagram

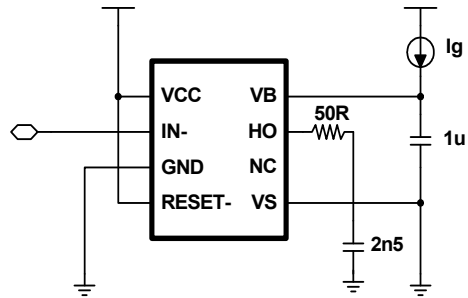

Figure3.b VB Drop Voltage Test Circuit

4.Recommendation Min. Short Pulse Width

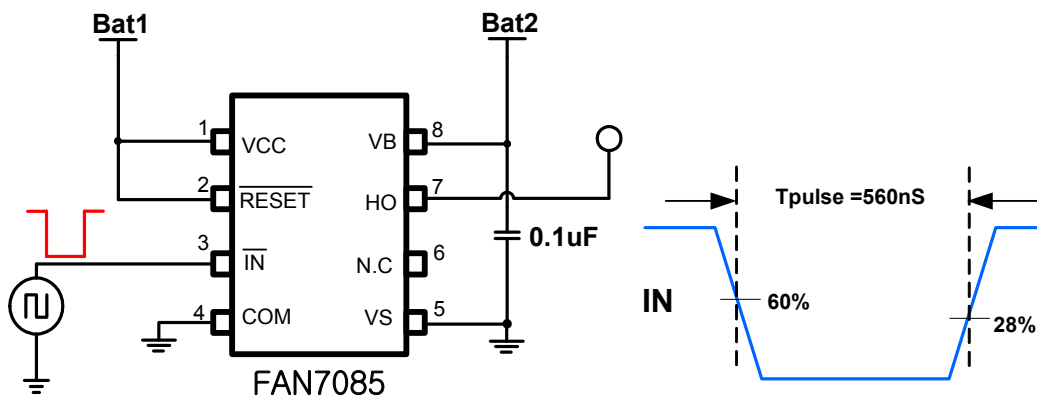

Figure 4a.Short Pulse Width Test Circuit and Pulse Width Waveform

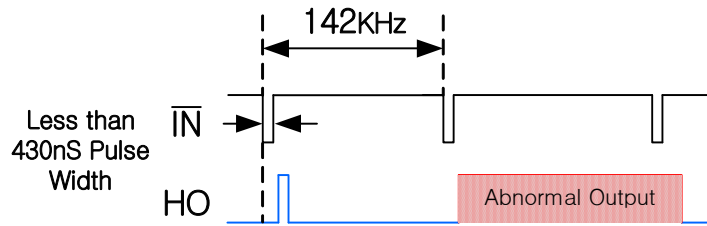

Figure 4b. Abnormal Output Waveform with short pulse width

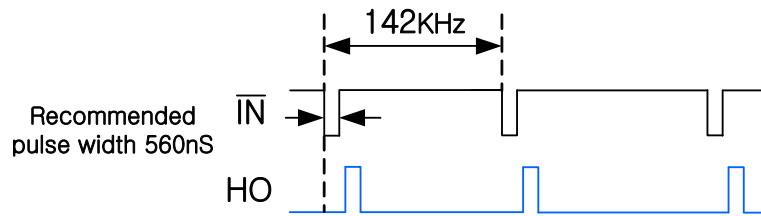

Figure 4c. Recommendation of pulse width Output Waveform

Performance Graphs

This performance graphs based on ambient temperature -40°C ~125°C

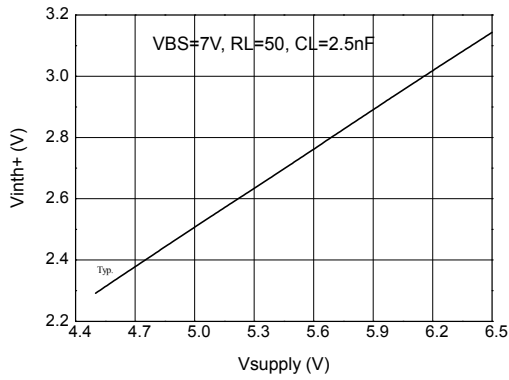

Figure 5a. Positive IN and RESET Threshold vs VCC Supply

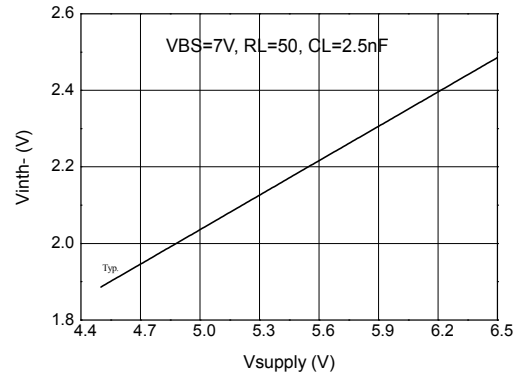

Figure 5b. Negative IN and RESET Threshold vs VCC Supply

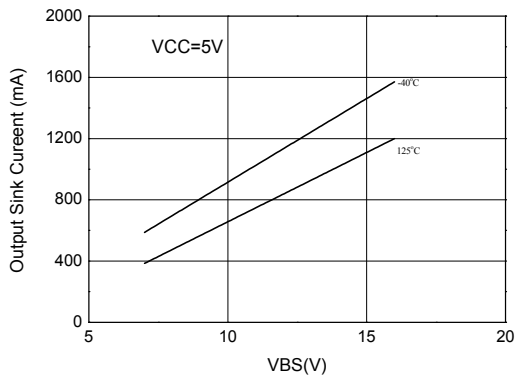

Figure6a. Output Sink Current vs VBS Supply

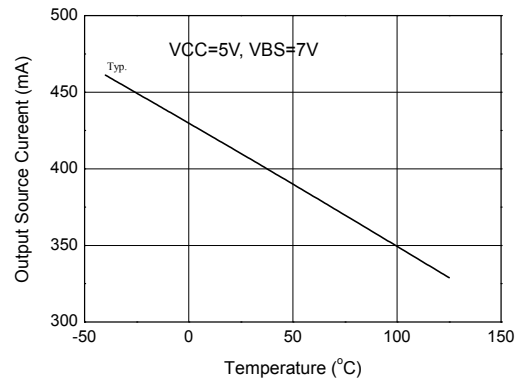

Figure6b. Output Source Current vs Temperature

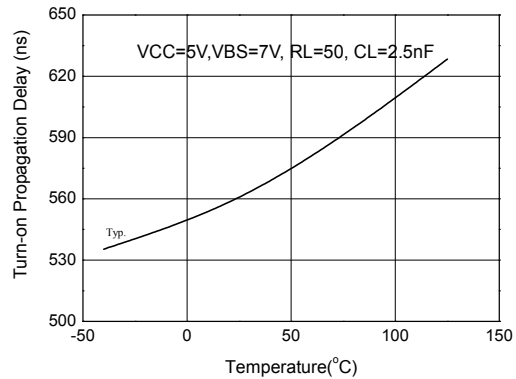

Figure 7a. Turn-On Propagation Delay Time vs Temperature

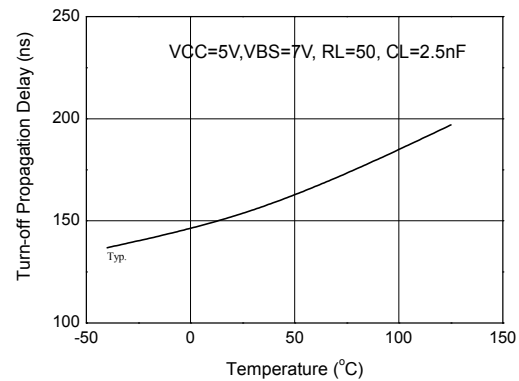

Figure 7b. Turn-Off Propagation Delay Time vs Temperature

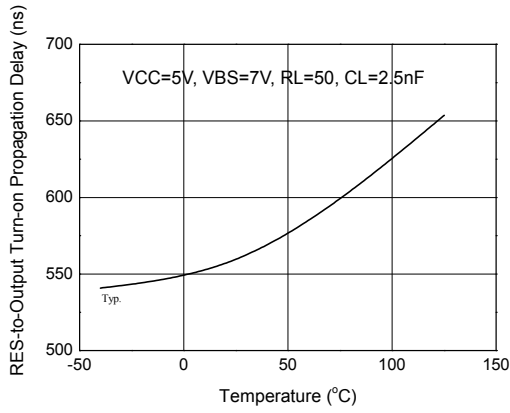

Figure 8a. RES to Output Turn-On Propagation Delay vs Temperature

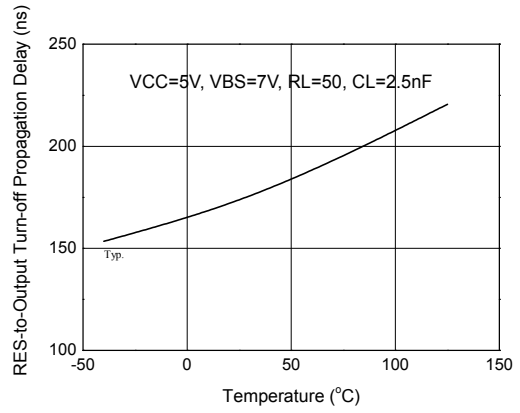

Figure 8b. RES to Output Turn-Off Propagation Delay vs Temperature

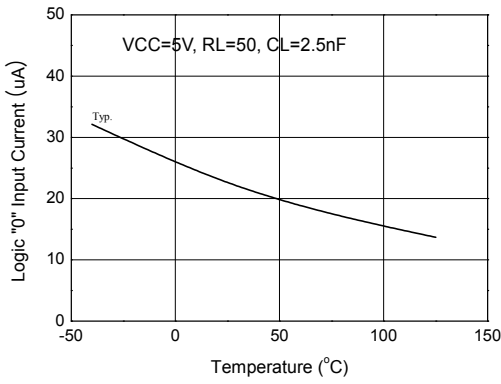

Figure 9. Logic "0" IN Input Current vs Temperature

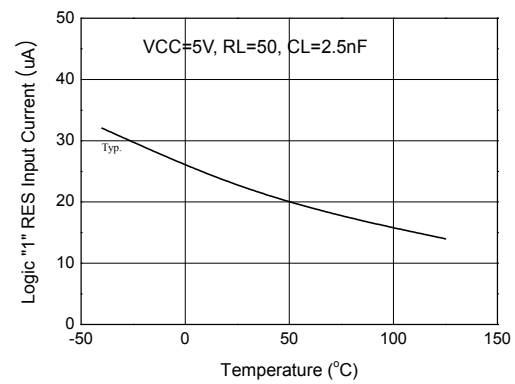

Figure 10. Logic "1" RESET Input Current vs Temperature

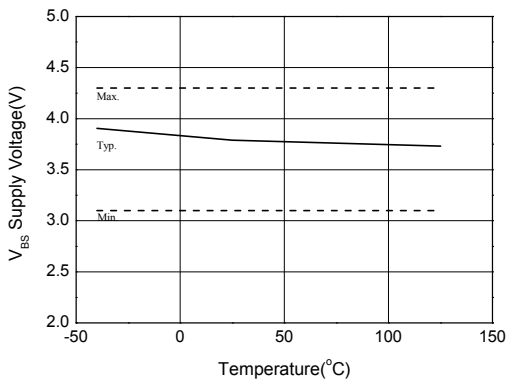

Figure 11a. VBS Under Voltage Threshold(+) vs Temperature

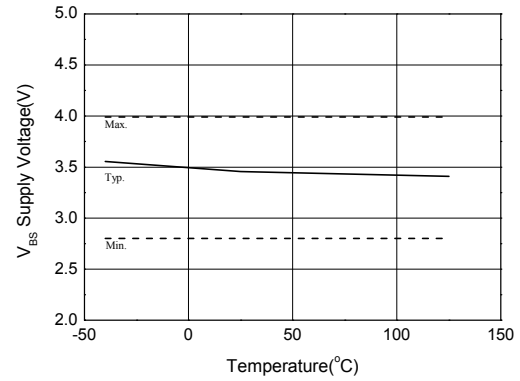

Figure 11b. VBS Under Voltage Threshold(-) vs Temperature

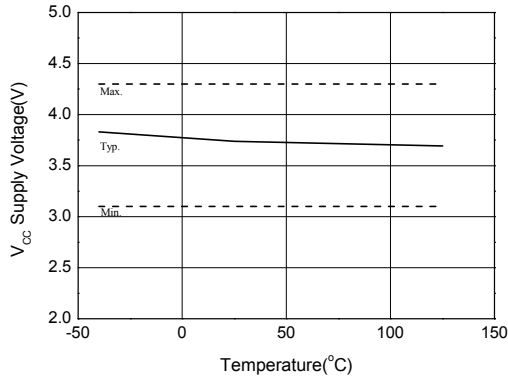

Figure 12a. VCC Under Voltage Threshold(+) vs Temperature

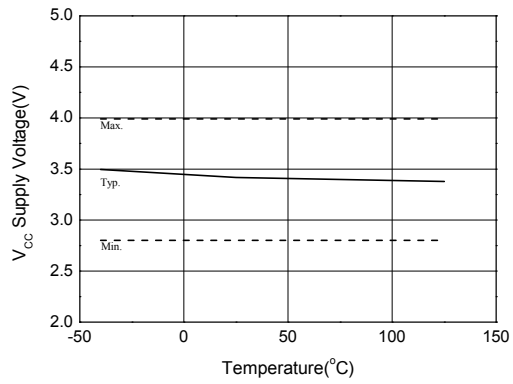

Figure 12b. VCC Under Voltage Threshold(-) vs Temperature

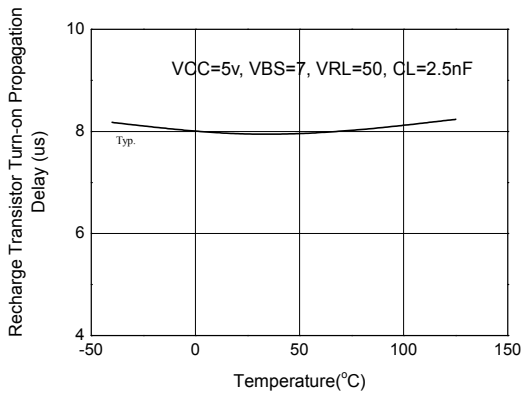

Figure 13. Recharge FET Turn-on Delay time

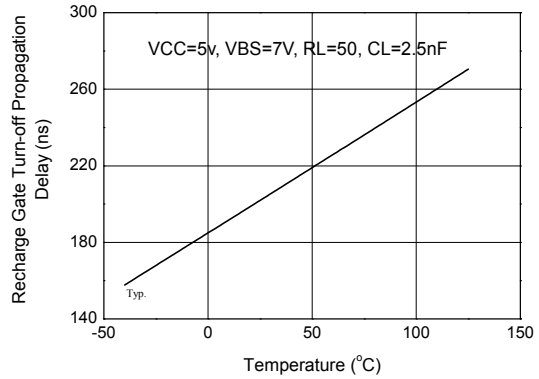

Figure 14. Recharge FET Turn-off Delay time

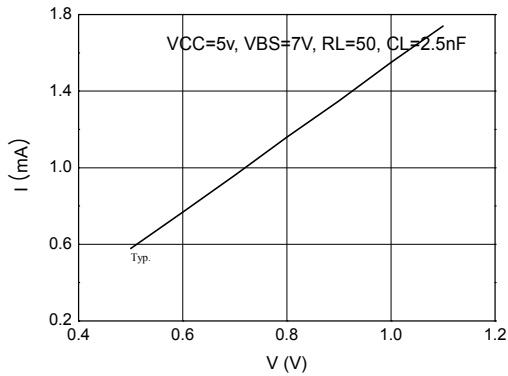

Figure 15. Recharge FET I-V curve

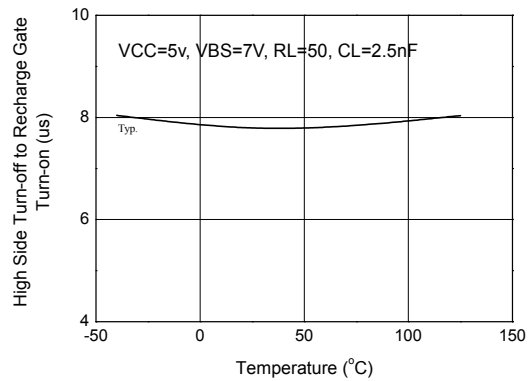

Figure 16. High Side Turn-off to Recharge FET turn-on VS Temperature

ON Semiconductor and  are trademarks of Semiconductor Components Industries, LLC dba ON Semiconductor or its subsidiaries in the United States and/or other countries. ON Semiconductor owns the rights to a number of patents, trademarks, copyrights, trade secrets, and other intellectual property. A listing of ON Semiconductor's product/patent coverage may be accessed at www.onsemi.com/site/pdf/Patent-Marking.pdf. ON Semiconductor reserves the right to make changes without further notice to any products herein. ON Semiconductor makes no warranty, representation or guarantee regarding the suitability of its products for any particular purpose, nor does ON Semiconductor assume any liability arising out of the application or use of any product or circuit, and specifically disclaims any and all liability, including without limitation special, consequential or incidental damages. Buyer is responsible for its products and applications using ON Semiconductor products, including compliance with all laws, regulations and safety requirements or standards, regardless of any support or applications information provided by ON Semiconductor. "Typical" parameters which may be provided in ON Semiconductor data sheets and/or specifications can and do vary in different applications and actual performance may vary over time. All operating parameters, including "Typicals" must be validated for each customer application by customer's technical experts. ON Semiconductor does not convey any license under its patent rights nor the rights of others. ON Semiconductor products are not designed, intended, or authorized for use as a critical component in life support systems or any FDA Class 3 medical devices or medical devices with a same or similar classification in a foreign jurisdiction or any devices intended for implantation in the human body. Should Buyer purchase or use ON Semiconductor products for any such unintended or unauthorized application, Buyer shall indemnify and hold ON Semiconductor and its officers, employees, subsidiaries, affiliates, and distributors harmless against all claims, costs, damages, and expenses, and reasonable attorney fees arising out of, directly or indirectly, any claim of personal injury or death associated with such unintended or unauthorized use, even if such claim alleges that ON Semiconductor was negligent regarding the design or manufacture of the part. ON Semiconductor is an Equal Opportunity/Affirmative Action Employer. This literature is subject to all applicable copyright laws and is not for resale in any manner.

PUBLICATION ORDERING INFORMATION

LITERATURE FULFILLMENT:

Literature Distribution Center for ON Semiconductor
19521 E. 32nd Pkwy, Aurora, Colorado 80011 USA
Phone: 303-675-2175 or 800-344-3860 Toll Free USA/Canada
Fax: 303-675-2176 or 800-344-3867 Toll Free USA/Canada
Email: orderlit@onsemi.com

N. American Technical Support: 800-282-9855 Toll Free
USA/Canada
Europe, Middle East and Africa Technical Support:
Phone: 421 33 790 2910
Japan Customer Focus Center
Phone: 81-3-5817-1050

ON Semiconductor Website: www.onsemi.com
Order Literature: <http://www.onsemi.com/orderlit>
For additional information, please contact your local
Sales Representative