

DF30JC10 Forward Voltage

Pulse measurement per diode

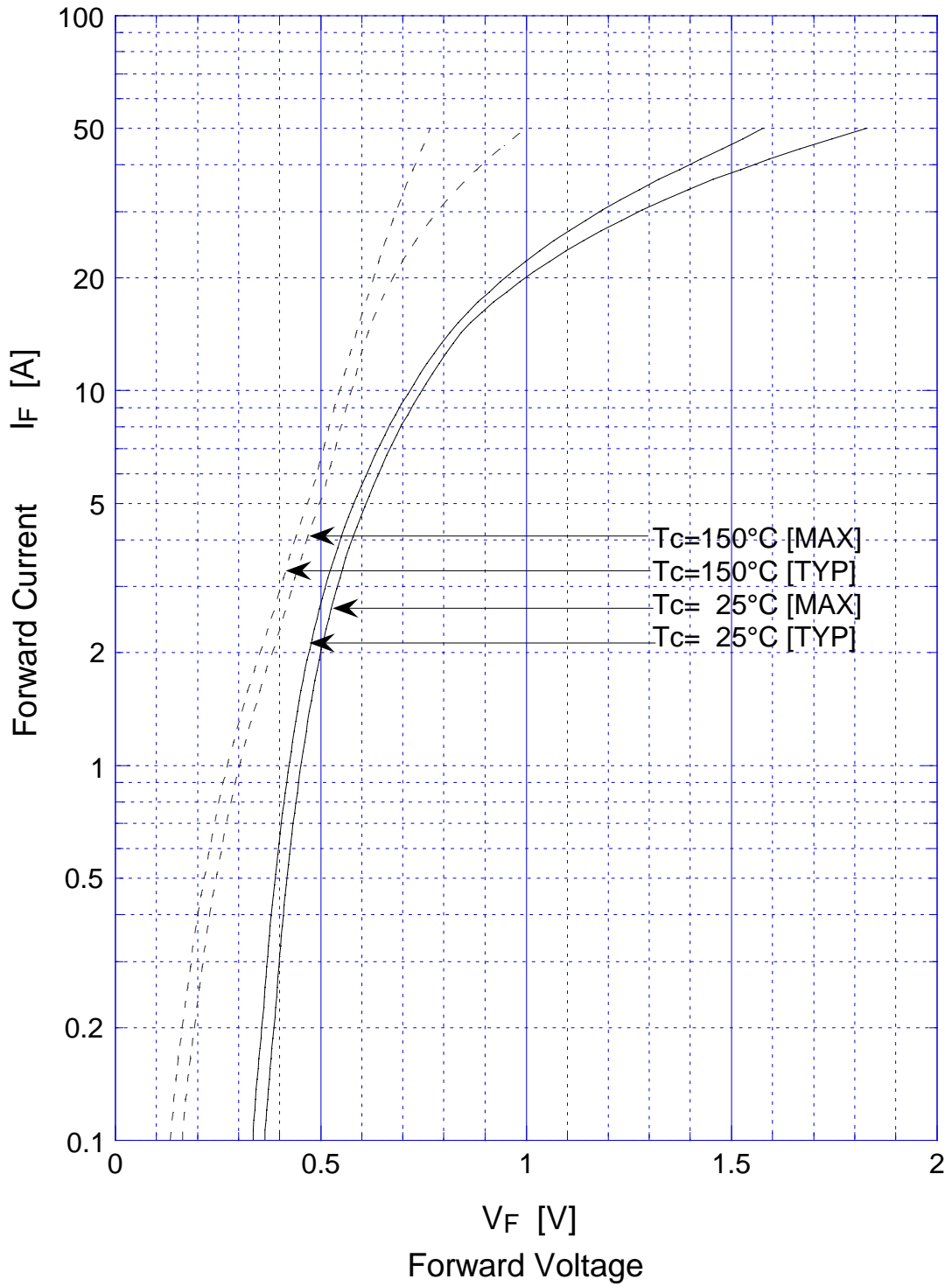

DF30JC10 Reverse Current

Pulse measurement per diode

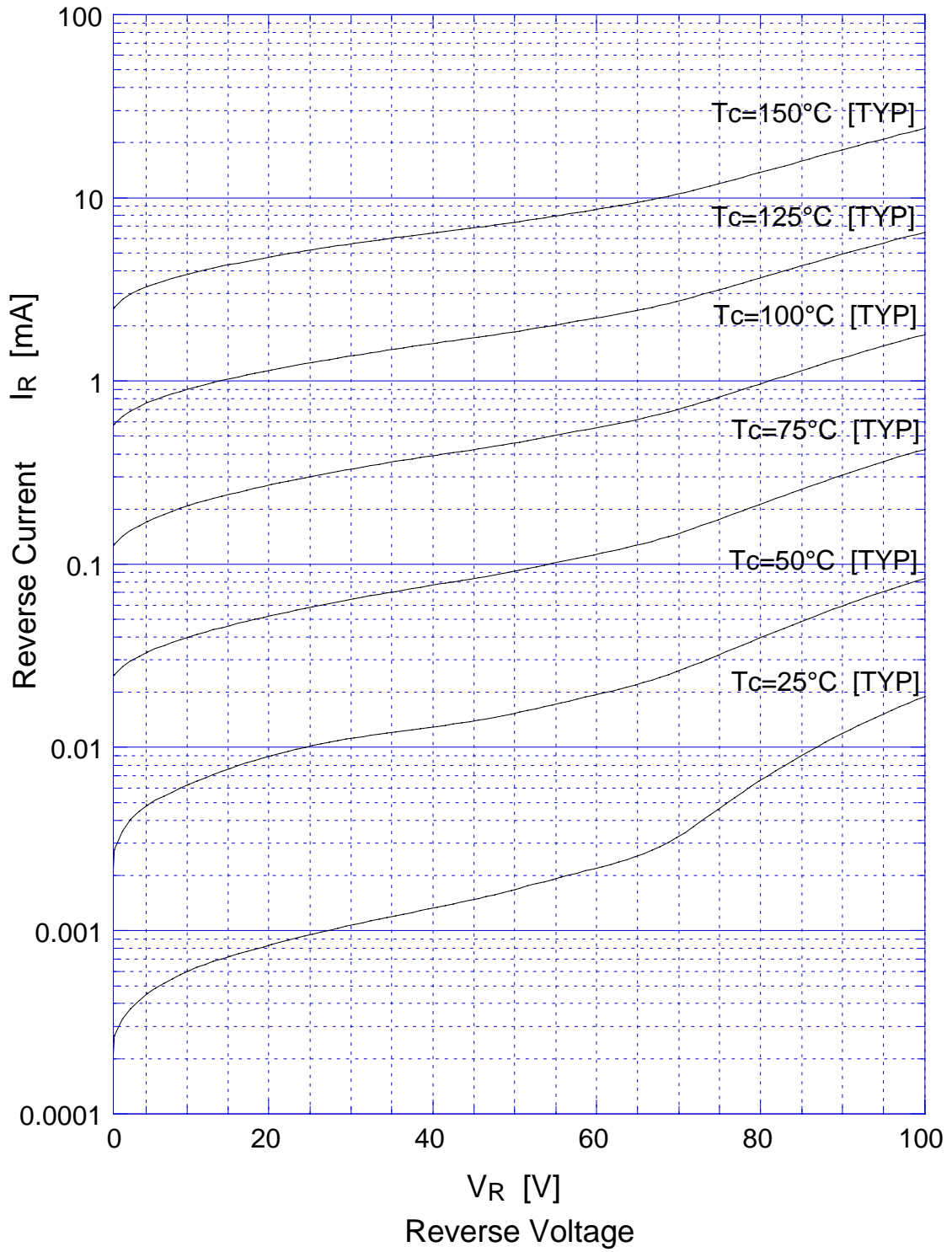

DF30JC10 Forward Power Dissipation

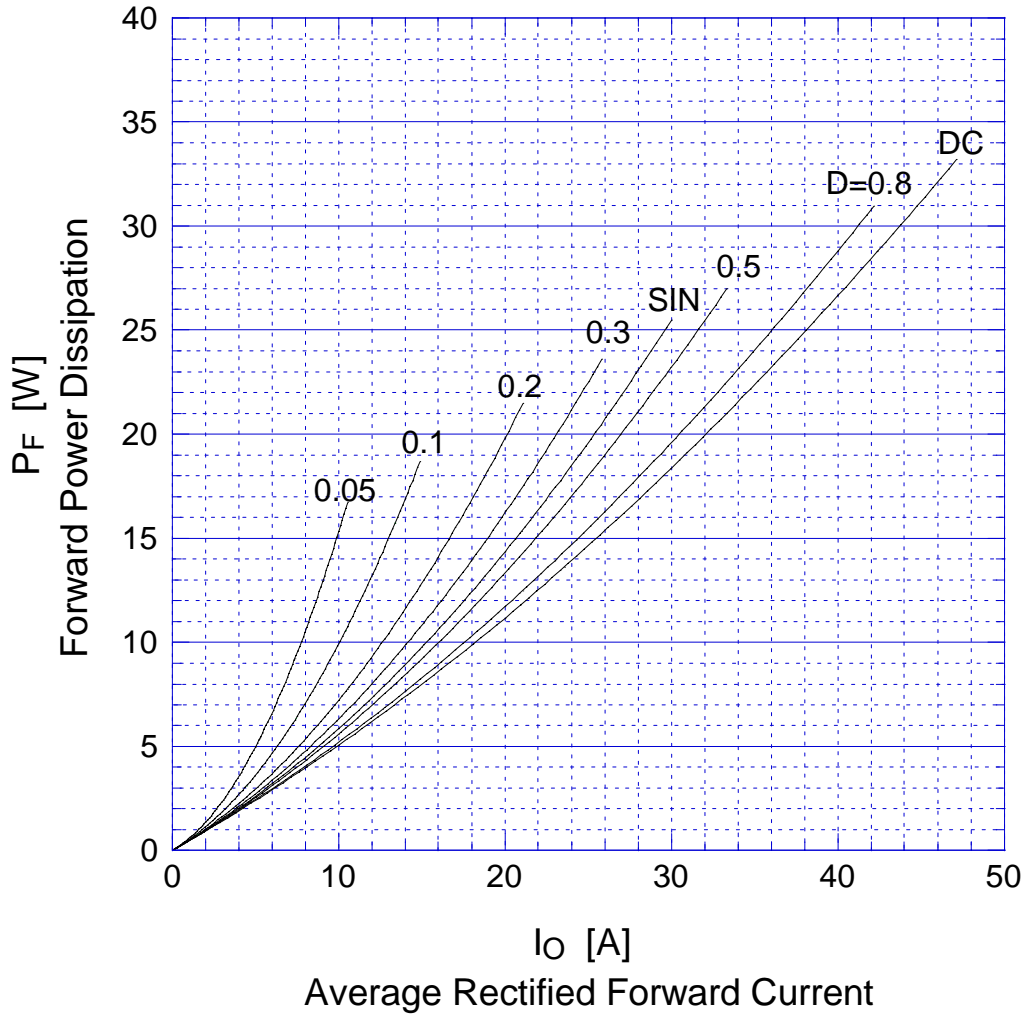

$T_j = 150^\circ\text{C}$

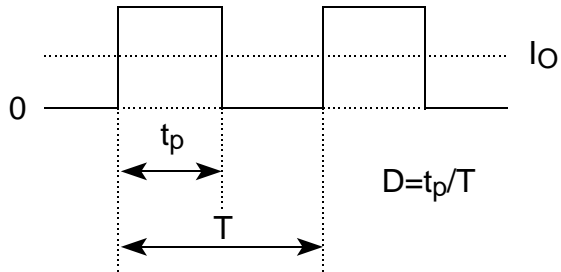

DF30JC10 Reverse Power Dissipation

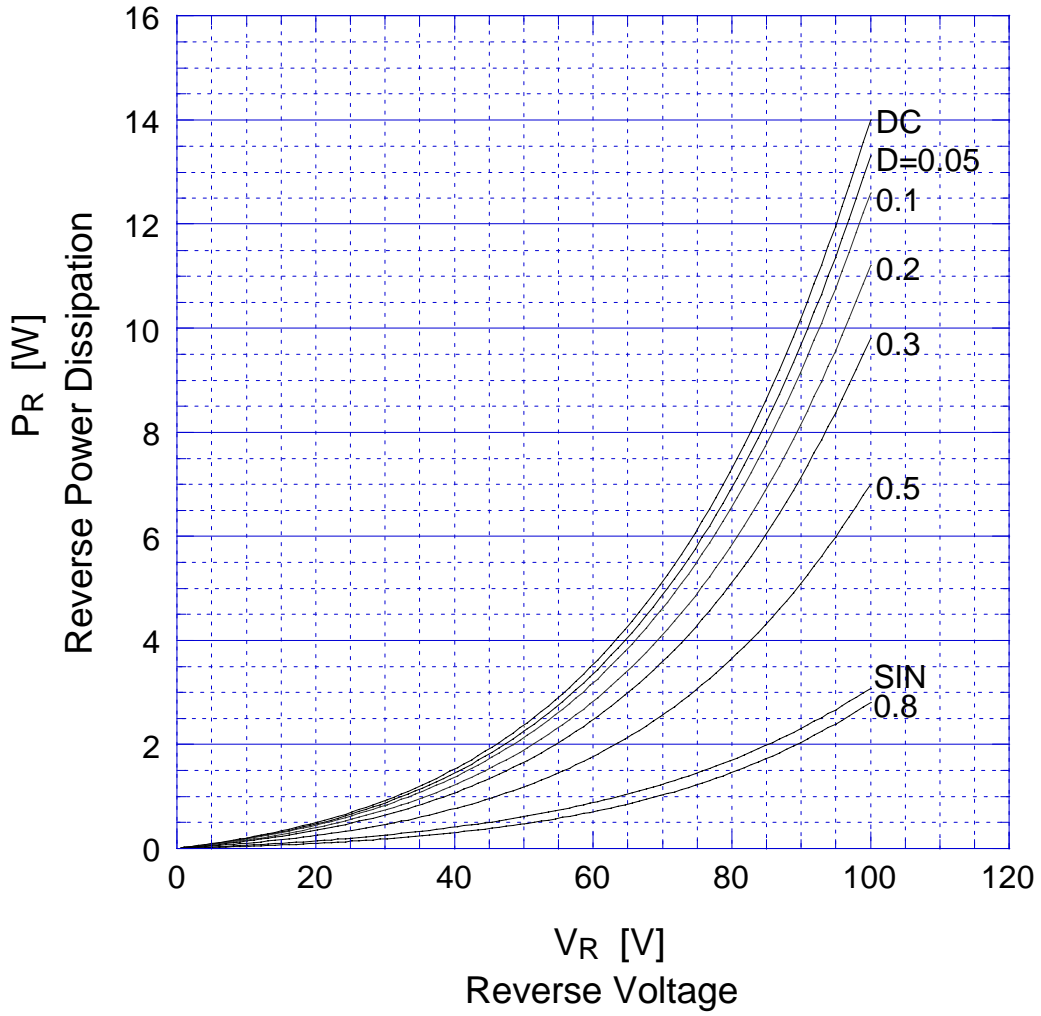

$T_j = 150^\circ\text{C}$

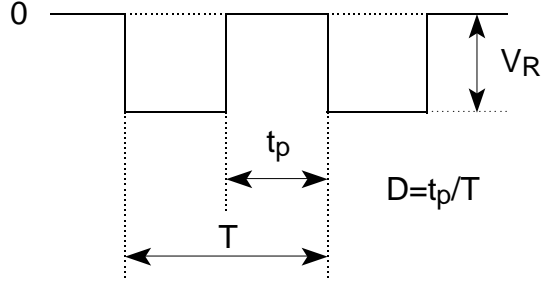

DF30JC10

Derating Curve

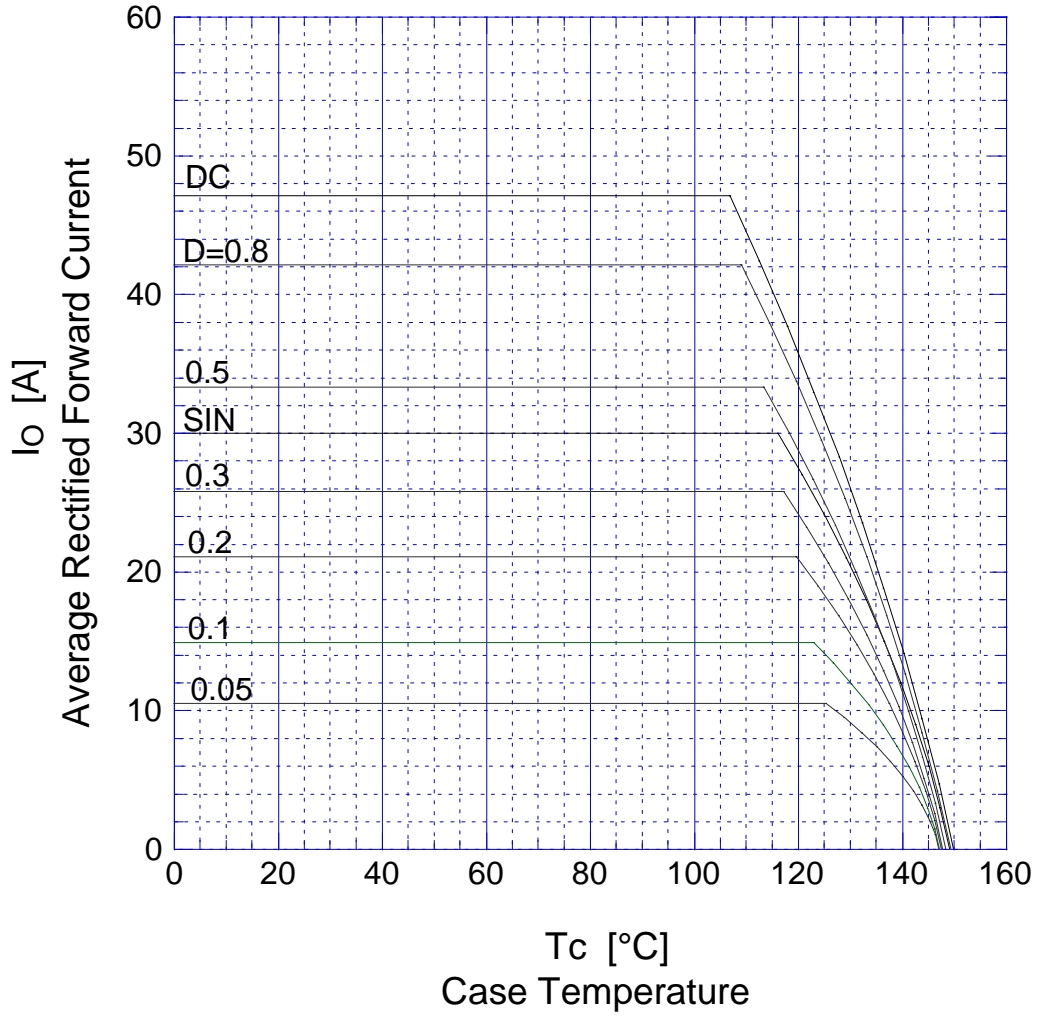

$V_R = 50V$

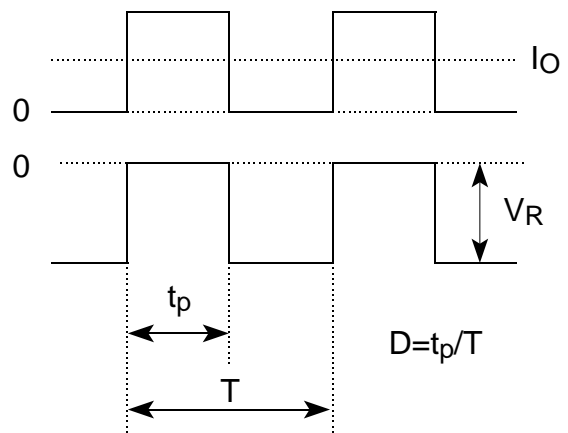

DF30JC10 Peak Surge Forward Capability

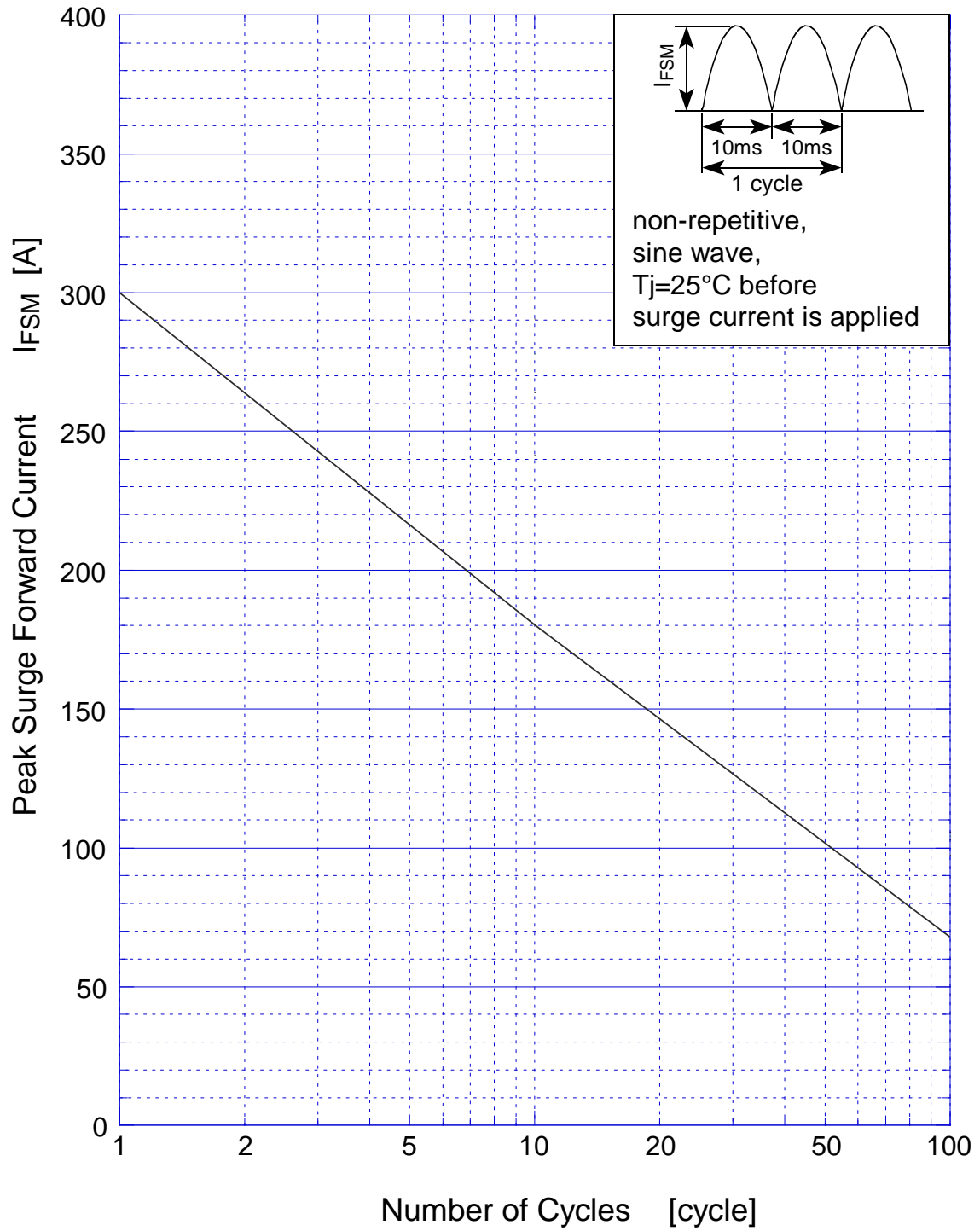

DF30JC10 Junction Capacitance

