

DETAILS

Product Number	F14304_FLORENCE-1R-Z90
Family	Florence
Type	Lens
Color	clear
Diameter	19,5 x 286 mm
Height	7 mm
Style	rectang
Optic Material	PMMA
Holder Material	
Fastening	clips
Status	production ready
ROHS Compliant	Yes
Date Updated	26/01/2017



OPTICAL PROPERTIES

LED	Viewing	Light	Effi-	cd/lm	Connector
	Angle	Beam	ciency		
L0-280024-xxx-C0800-L267	88+106 deg	WWW-class	92 %	0.400	-
XH-B/G	97+117 deg	WWW-class	90 %	0.350	-
LUXEON 3535 2D	92+110 deg	WWW-class	93 %	0.390	-
LUXEON 3030 2D	88+108 deg	WWW-class	92 %	0.420	-
LUXEON 3014	91+109 deg	WWW-class	94 %	0.420	-
LUXEON 3535L	92+109 deg	WWW-class	94 %	0.410	-
LUXEON 3020	89+108 deg	WWW-class	94 %	0.430	-
MP-2016	89+108 deg	WWW-class	93 %	0.420	-
NF2x757D	90+110 deg	WWW-class	93 %	0.400	-
NF2x757G	90+108 deg	WWW-class	92 %	0.400	-
Duris S5 (2 chip)	90+113 deg	WWW-class	94 %	0.400	-
Duris E 2835	sim: 94+106	WWW-class	sim: 93 %	sim: 0.390	-
Fortimo LED Line 1ft 1100lm xx0 1R xV2906	90+110 deg	WWW-class	94 %	0.410	-
LM302A	90+108 deg	WWW-class	93 %	0.410	-
LM561B	91+109 deg	WWW-class	93 %	0.390	-
LM301A	89+109 deg	WWW-class	94 %	0.430	-
LT-S282N	91+109 deg	WWW-class	94 %	0.420	-
LM561C	90+110 deg	WWW-class	94 %	0.420	-
LM28xB Series	91+111 deg	WWW-class	94 %	0.420	-
SEOUL 3030	90+109 deg	WWW-class	92 %	0.410	-
CALGD0414-M8W1	89+115 deg	WWW-class	93 %	0.380	-
CALGD0814-M17W1	90+114 deg	WWW-class	93 %	0.380	-

H G F E D C B A

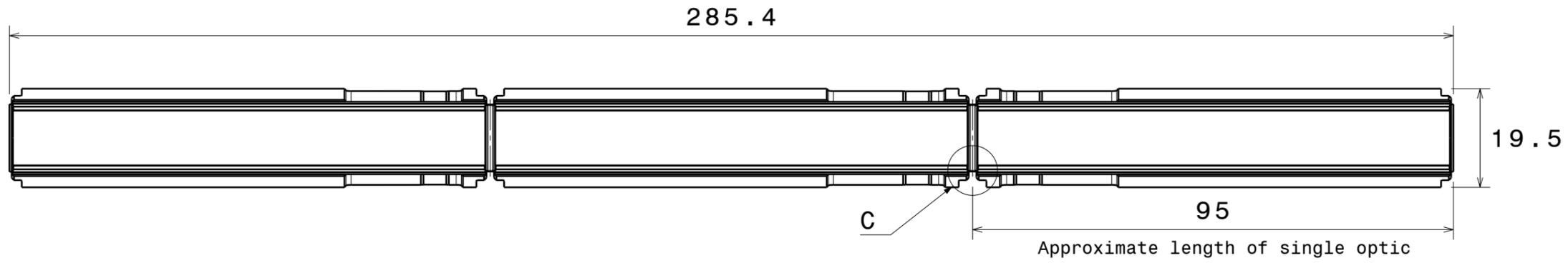

Bottom view

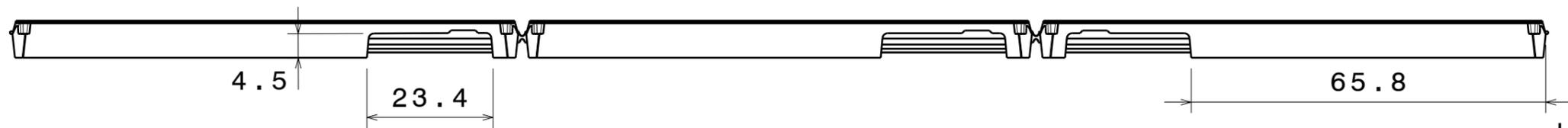

Left view

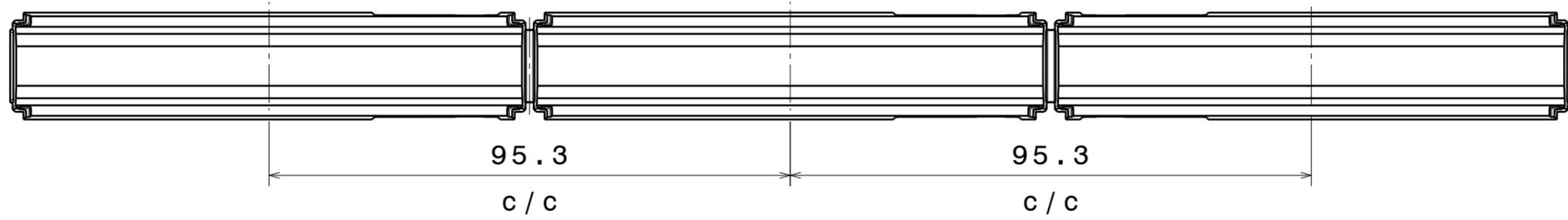

Top view

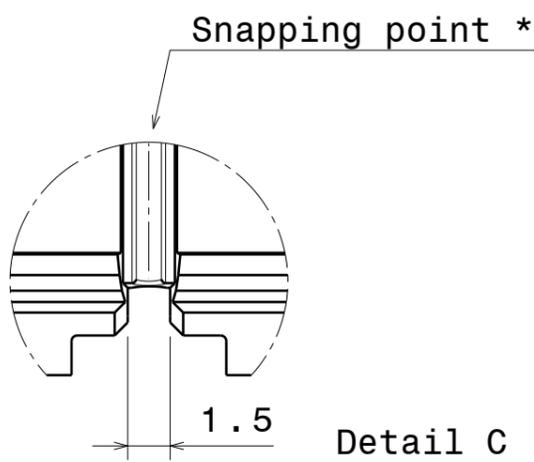

Detail C
Scale 4:1

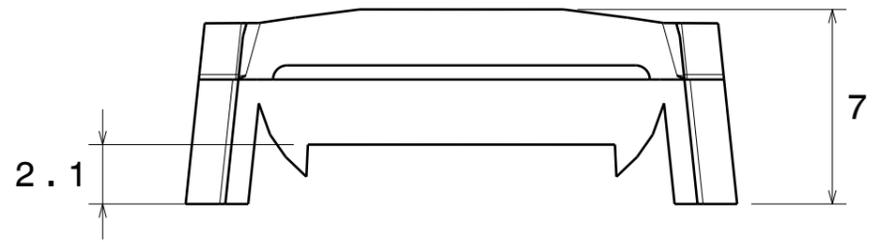

Front view
Scale 4:1

* Optics can be snapped along this line and used also as single parts.

Tolerances if not otherwise shown
According to DIN ISO 2768-1
Linear measures:
Up to 30mm class M, otherwise class C.
According to DIN ISO 2768-2
Form and position: class L

LEDiL LediL Oy
Salorankatu 10
FIN 24240 SALO
Finland

THIRD ANGLE PROJECTION:

DRAWING TITLE
Datasheet FLORENCE-1R

This drawing is the property of LEDiL Oy. It may not be reproduced, copied or communicated without a written agreement with LEDiL Oy.

SIZE	PART NUMBER		
A3	-		

SCALE	1:1	WEIGHT	-	SHEET	1/1
-------	-----	--------	---	-------	-----

H G B A

Luminaire: Ledil F14304_FLORENCE-1R-Z90_(CeZos)

Lamps: 1 x CeZos_(L0-280024-xxx-C0800-L267)_1346.29lm@250mA_CCT=3000K_P=8.5017W_I=0.25A

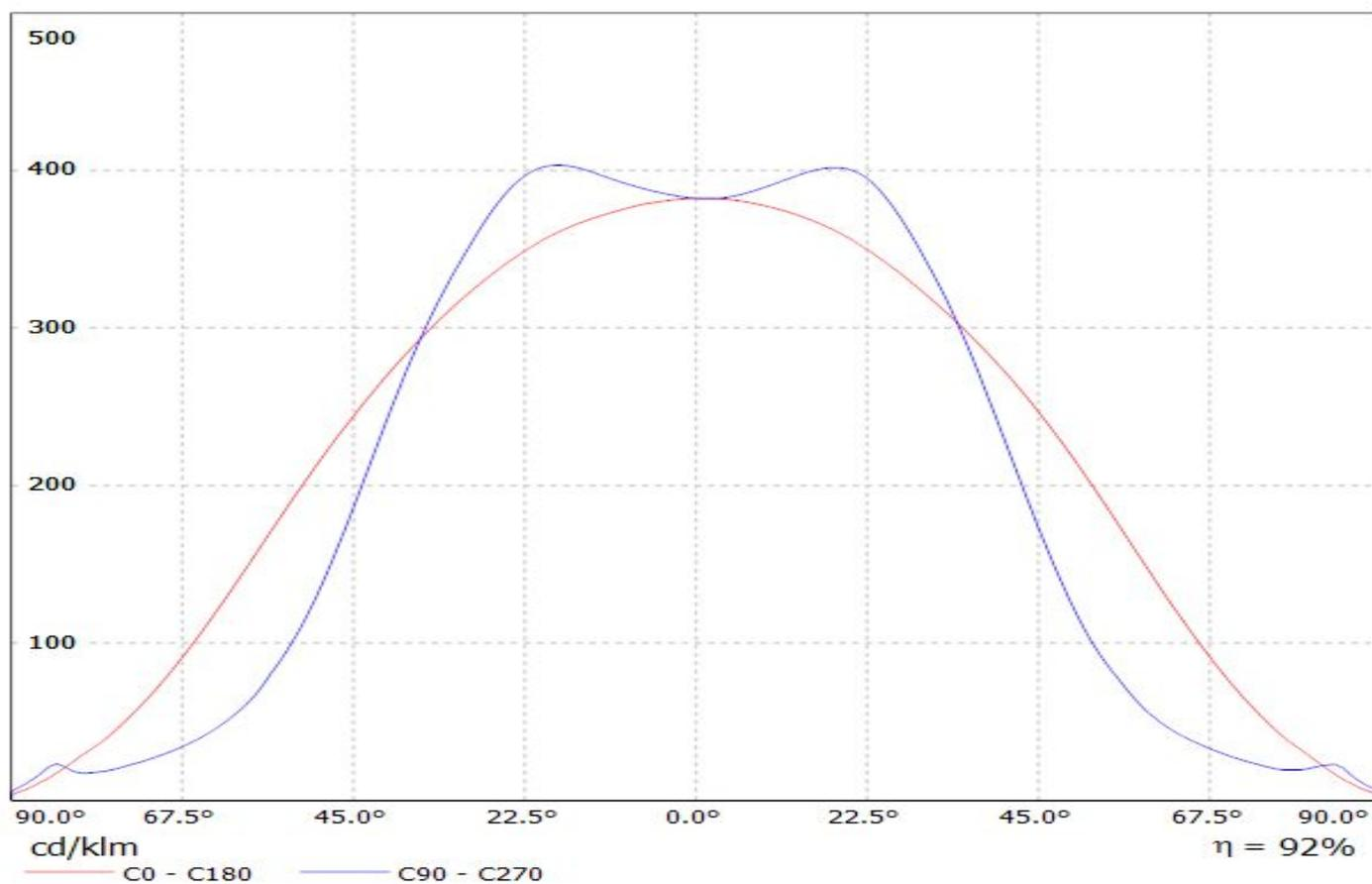

Ledil F14304_FLORENCE-1R-Z90_(XH-B) / LDC (Linear)

Luminaire: Ledil F14304_FLORENCE-1R-Z90_(XH-B)

Lamps: 1 x Cree_XH-B_x22_(XHBAAWT-0-7B4-J20-0H-0001)_315.848lm@65mA_P=2.11W_I=65mA

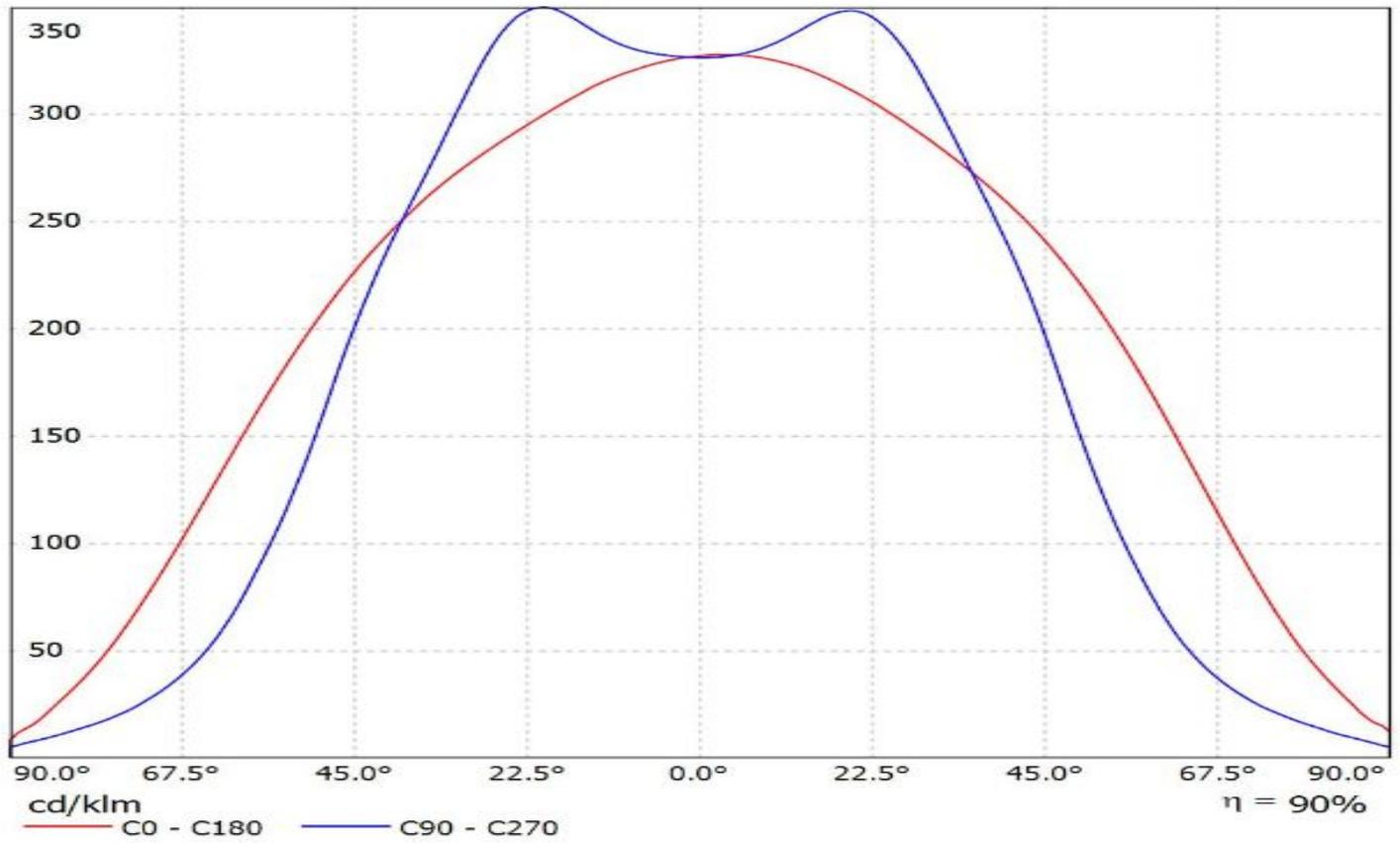

Ledil F14304_FLORENCE-1R-Z90_(Luxeon_3535_2D) / LDC (Linear)

Luminaire: Ledil F14304_FLORENCE-1R-Z90_(Luxeon_3535_2D)

Lamps: 1 x Luxeon_3535_2D_x22_(MXC8_4000K)_910.245lm@100mA_CCT=4000K_P=6.32W_I=0.1A

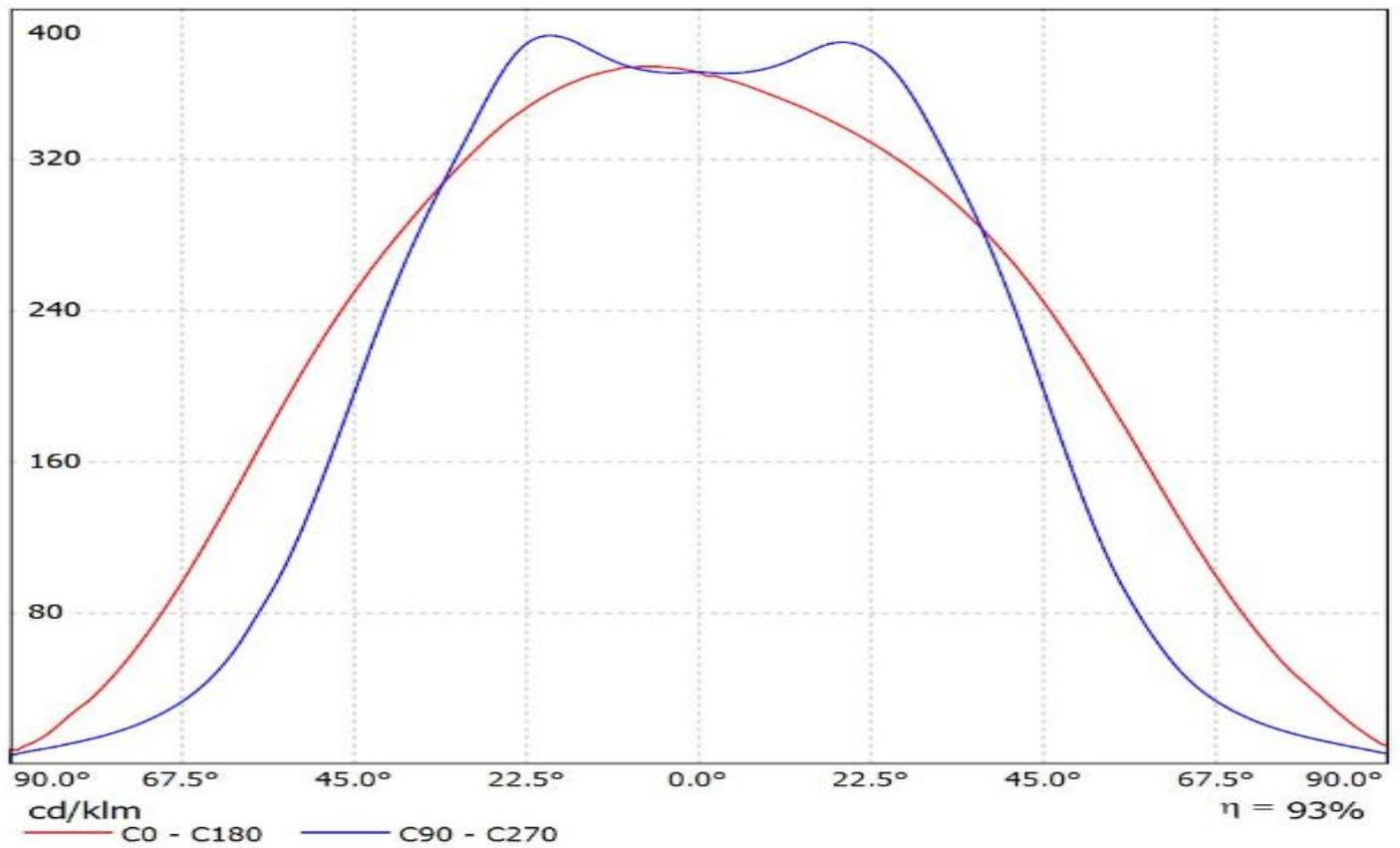

Ledil F14304_FLORENCE-1R-Z90_(Luxeon_3030_2D) / LDC (Linear)

Luminaire: Ledil F14304_FLORENCE-1R-Z90_(Luxeon_3030_2D)
Lamps: 1 x Luxeon_3030_2D_x22_(L130-4080003000W21)
_1601.44lm@200mA_CCT=4000K_P=12.8W_I=0.2A

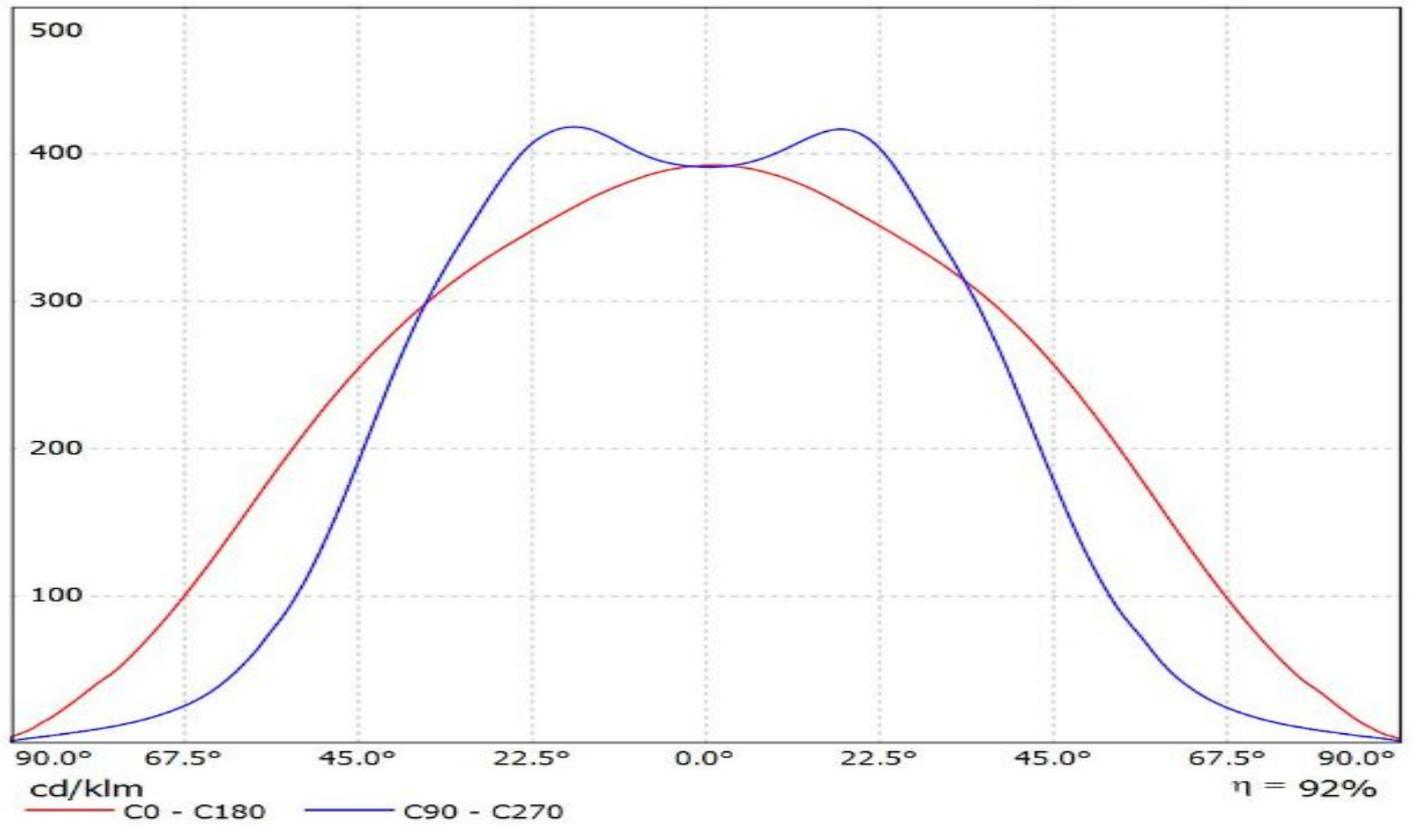

Luminaire: Ledil F14304_FLORENCE-1R-Z90_(3014_x22)

Lamps: 1 x Luxeon_3014_x22_(L130-5080)_282.652lm@60mA_P=1.9076W_I=0.060mA

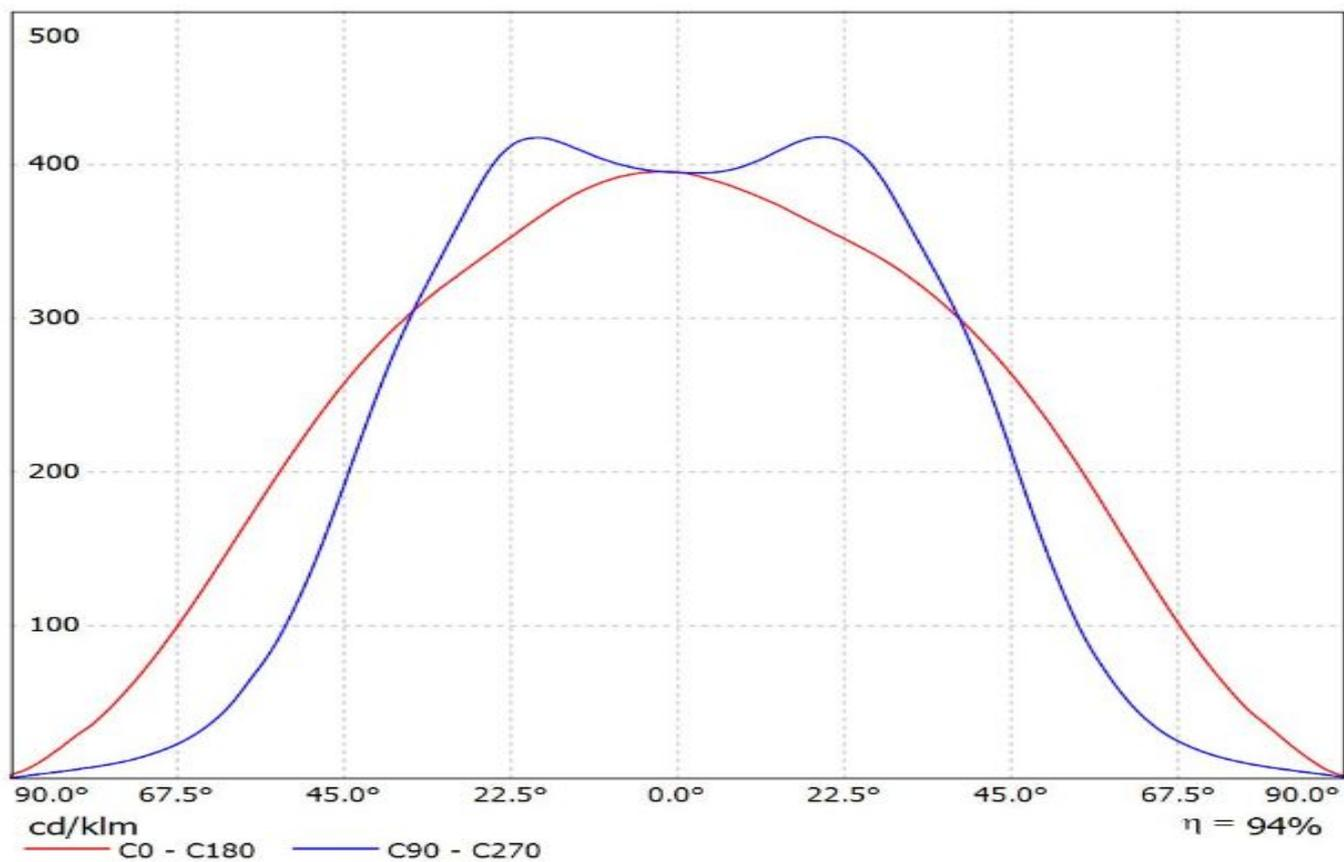

Luminaire: Ledil F14304_FLORENCE-1R-Z90_(3535L_x22)

Lamps: 1 x Luxeon_3535L_x22_(MXA8-PW50)_507.681lm@100mA_P=2.9953W_I=0.100mA

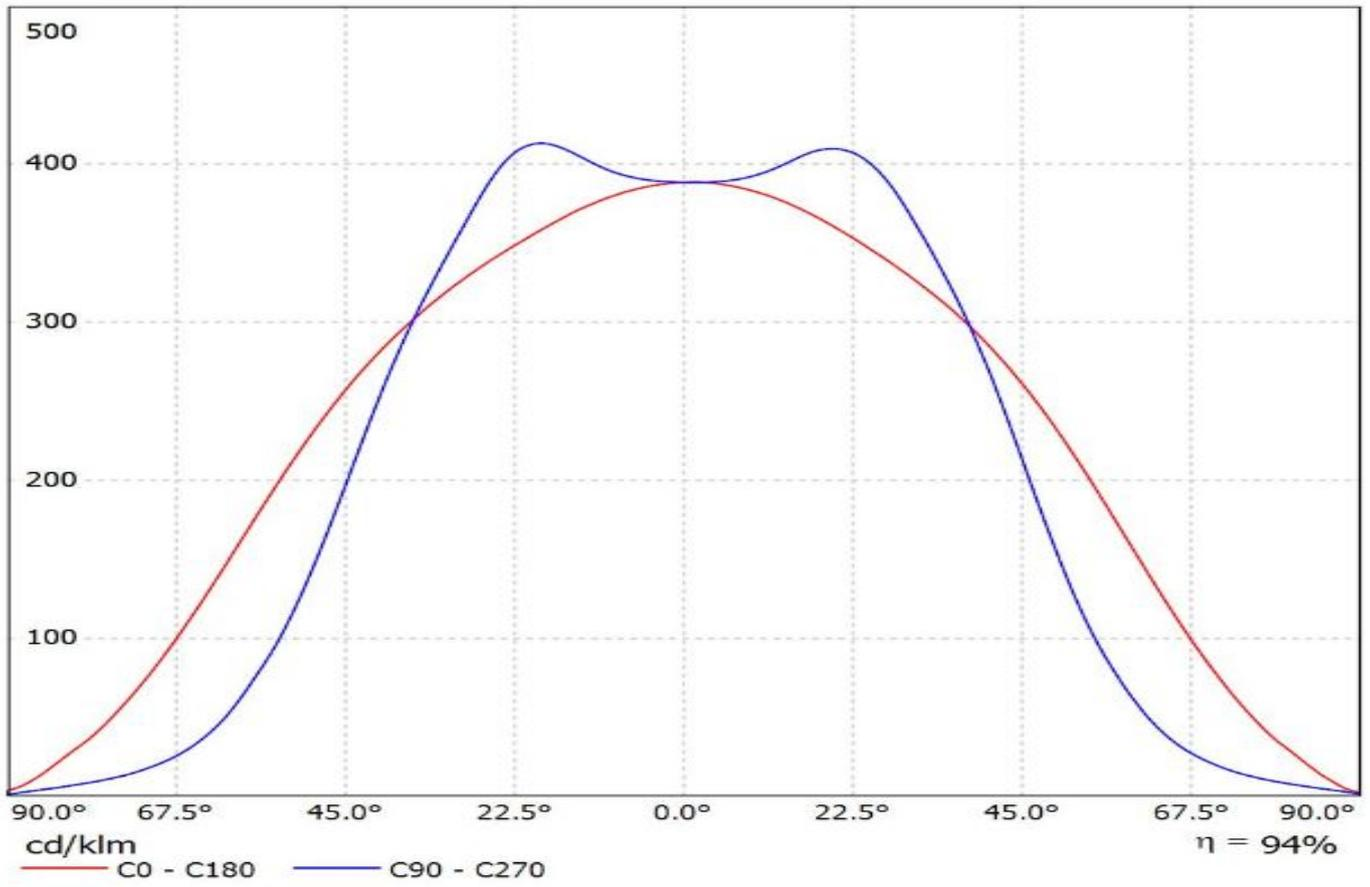

Luminaire: Ledil F14304_FLORENCE-1R-Z90_(3020)

Lamps: 1 x Luxeon_3020_x22_(L130-2780)_488.066lm@120mA_P=3.7731W_I=0.120mA

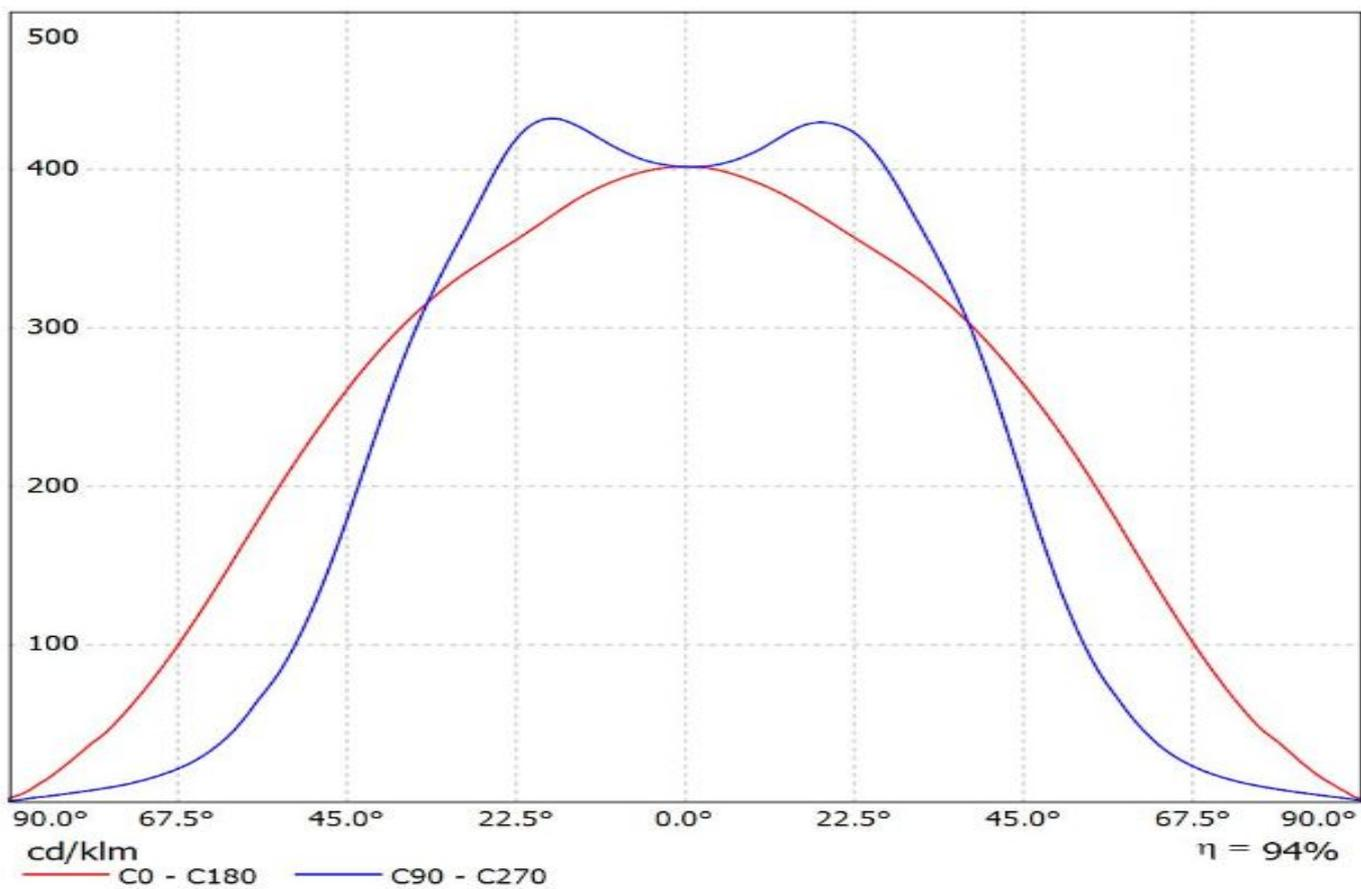

Ledil F14304_FLORENCE-1R-Z90_(Luminus_MP-2016) / LDC (Linear)

Luminaire: Ledil F14304_FLORENCE-1R-Z90_(Luminus_MP-2016)

Lamps: 1 x Luminus_MP-2016_1x22_(LUMMP-1100-30-80)_471.904lm@120mA_P=4W_I=0.12A

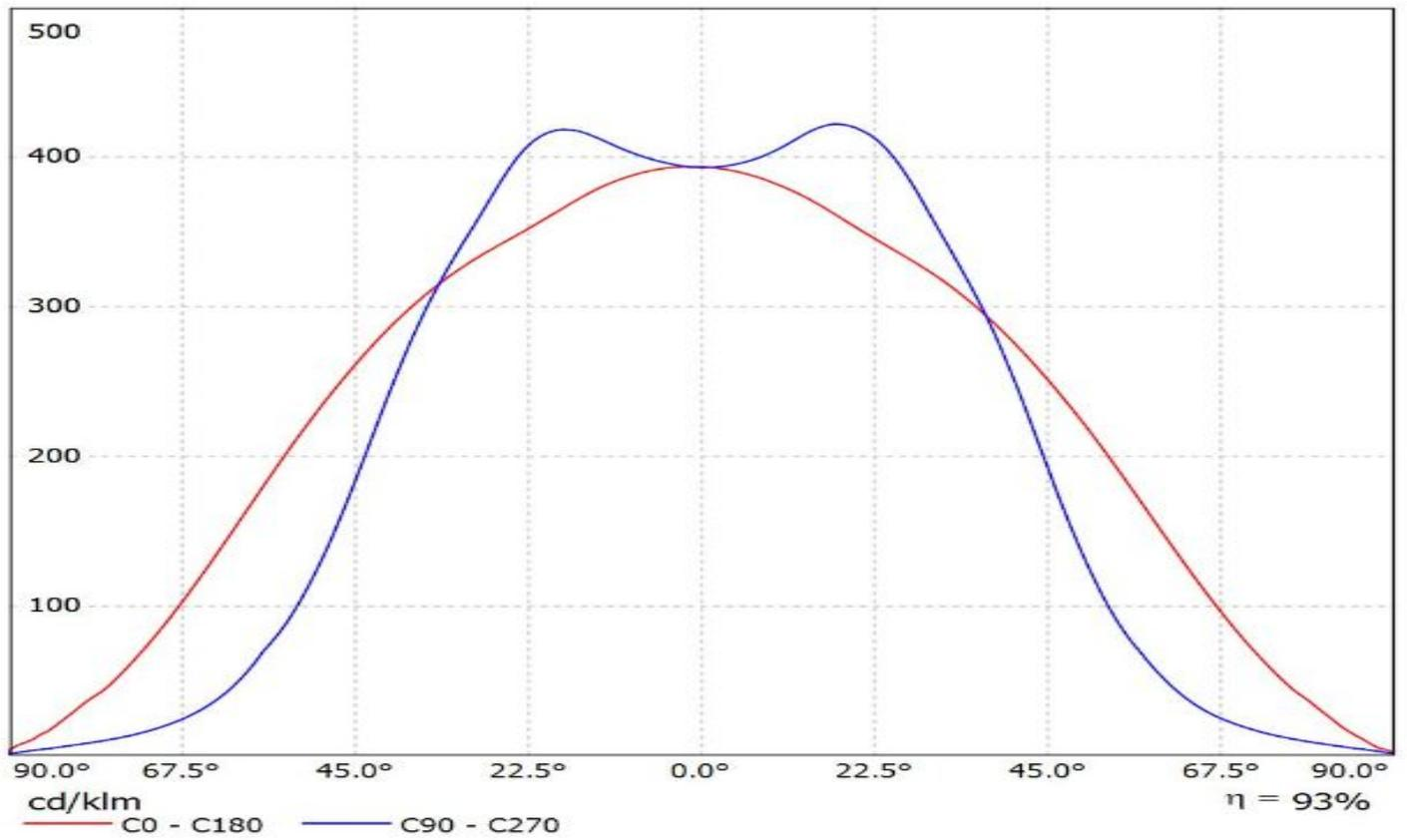

Ledil F14304_FLORENCE-1R-Z90_(NF2x757D) / LDC (Linear)

Luminaire: Ledil F14304_FLORENCE-1R-Z90_(NF2x757D)

Lamps: 1 x Nichia_NF2x757D_2chip_x22 (NF2W757DRT)_2050.61lm@200mA_P=12.95W_I=0.2A

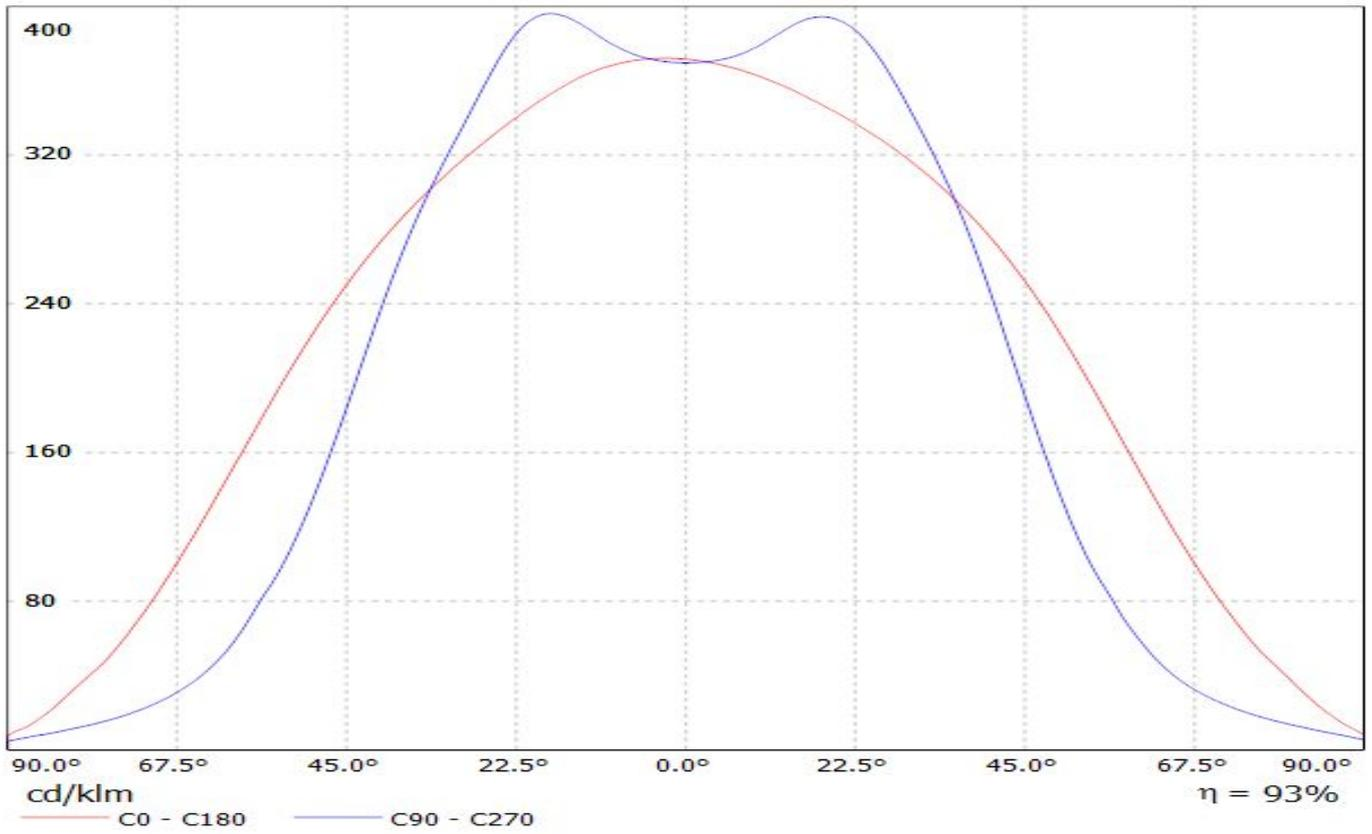

Luminaire: Ledil F14304_FLORENCE-1R-Z90_(NF2W757G)
Lamps: 1 x NF2W757G_377.885lm@65mA_CCT=?K_P=1.97W_I=0.065A

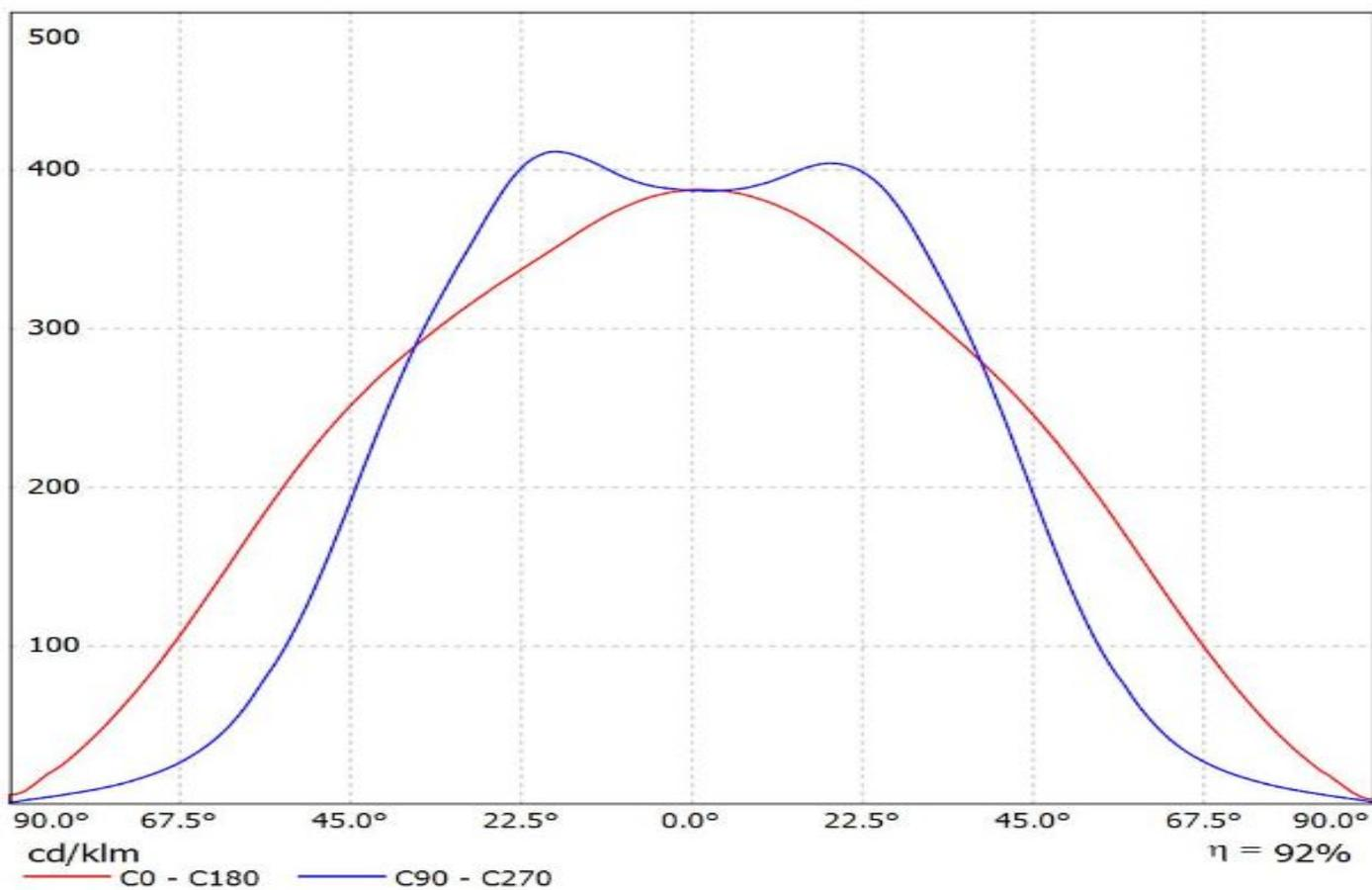

Luminaire: Ledil F14304_FLORENCE-1R-Z90_(Duris_S5)

Lamps: 1 x Osram_Duris_S5_(GW_PSLRS1.ÉC-LQLS-5H7I-1)_993.467lm@100mA_P=8W_I=0.1000A

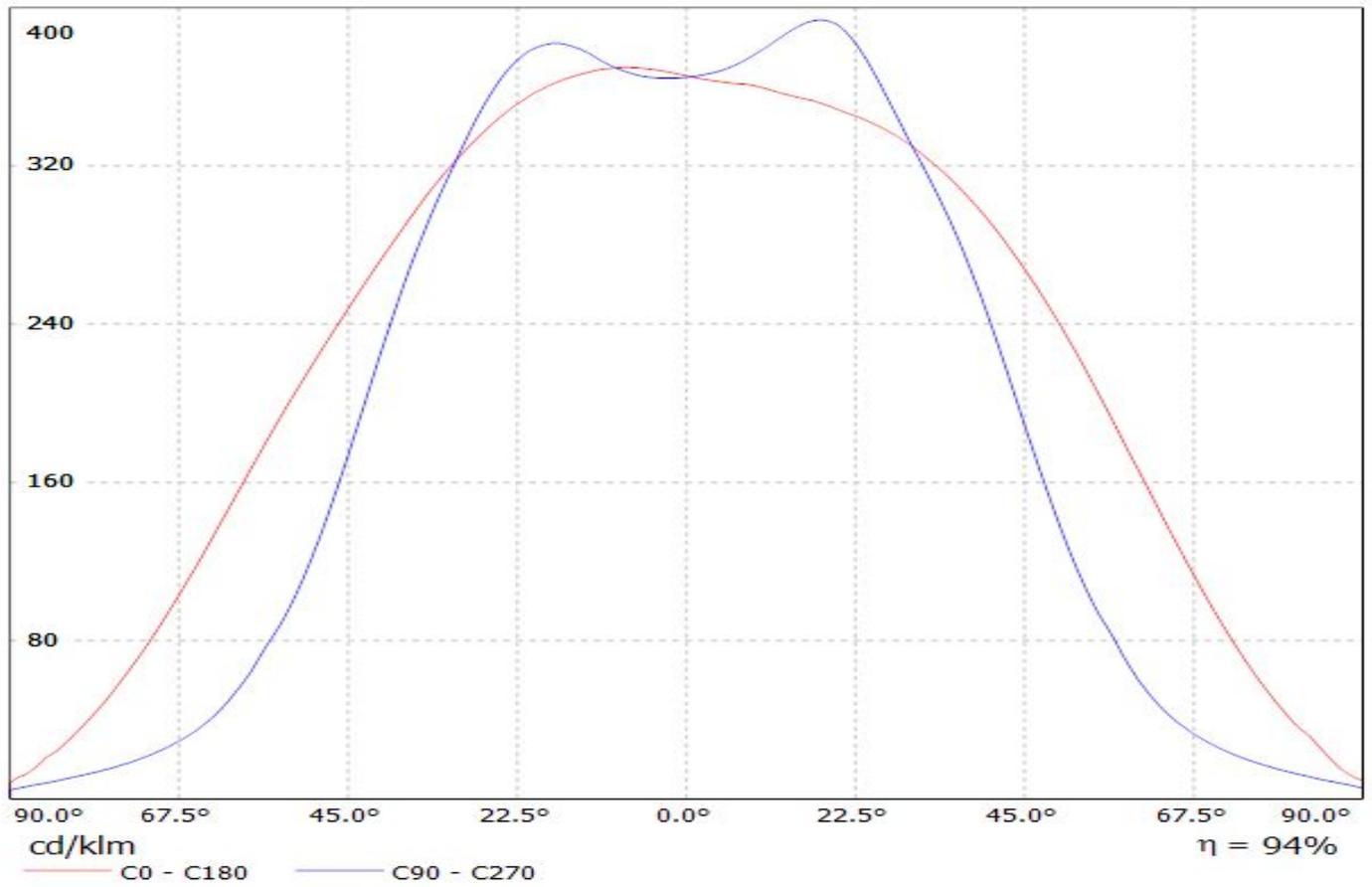

Luminaire: Ledil Oy F14304_FLORENCE-1R-Z90_(Duris_E_2835)_SIMULATED
Lamps: 1 x Osram Duris E 2835 - GW JTLRS1.EM

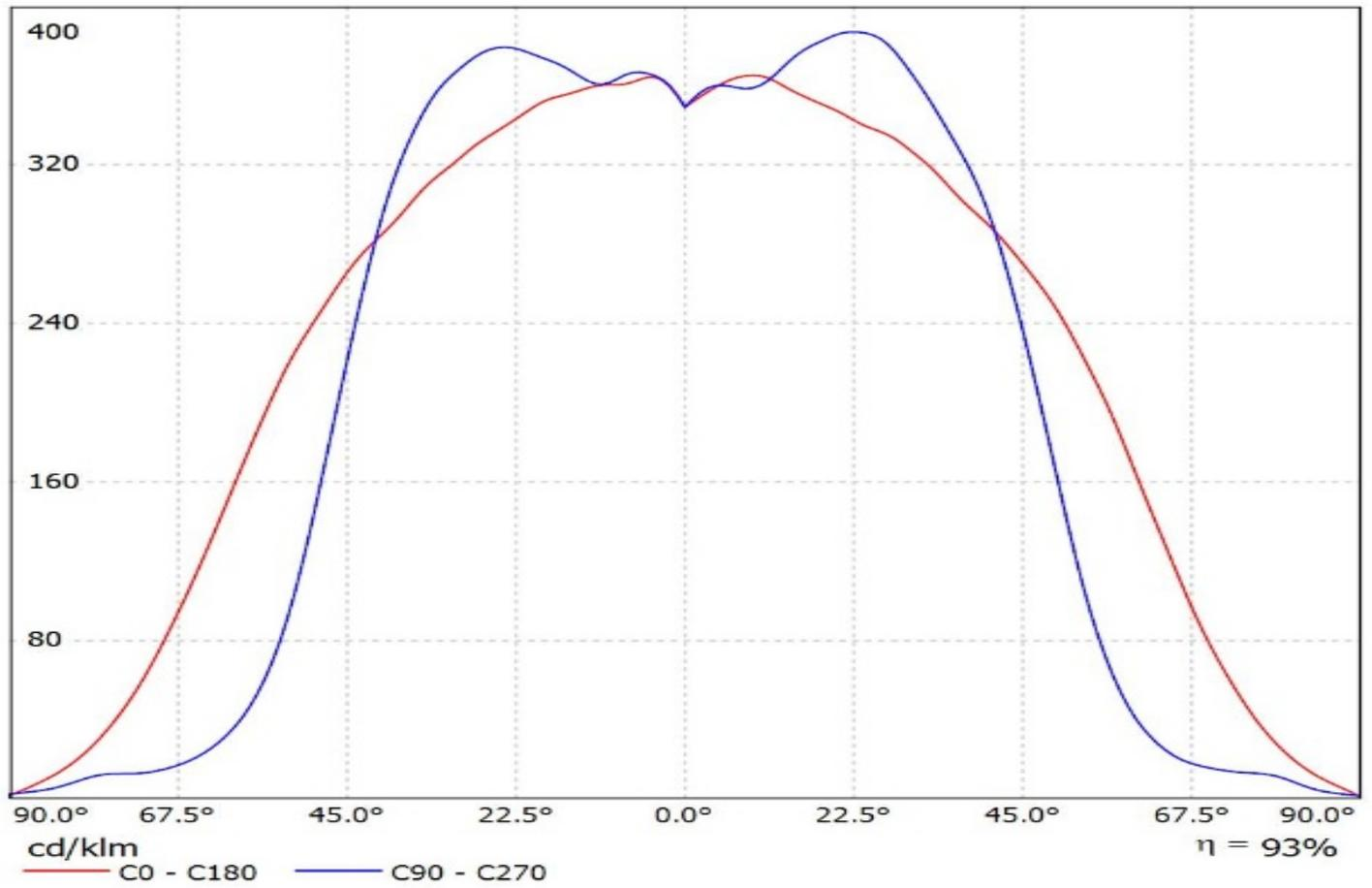

Luminaire: LEDiL Oy F14304_FLORENCE-1R-Z90

Lamps: 1 x Fortimo LED Line 1ft 1100lm 1R_1033.71lm@250mA_P=8.41851W_I=249.8mA

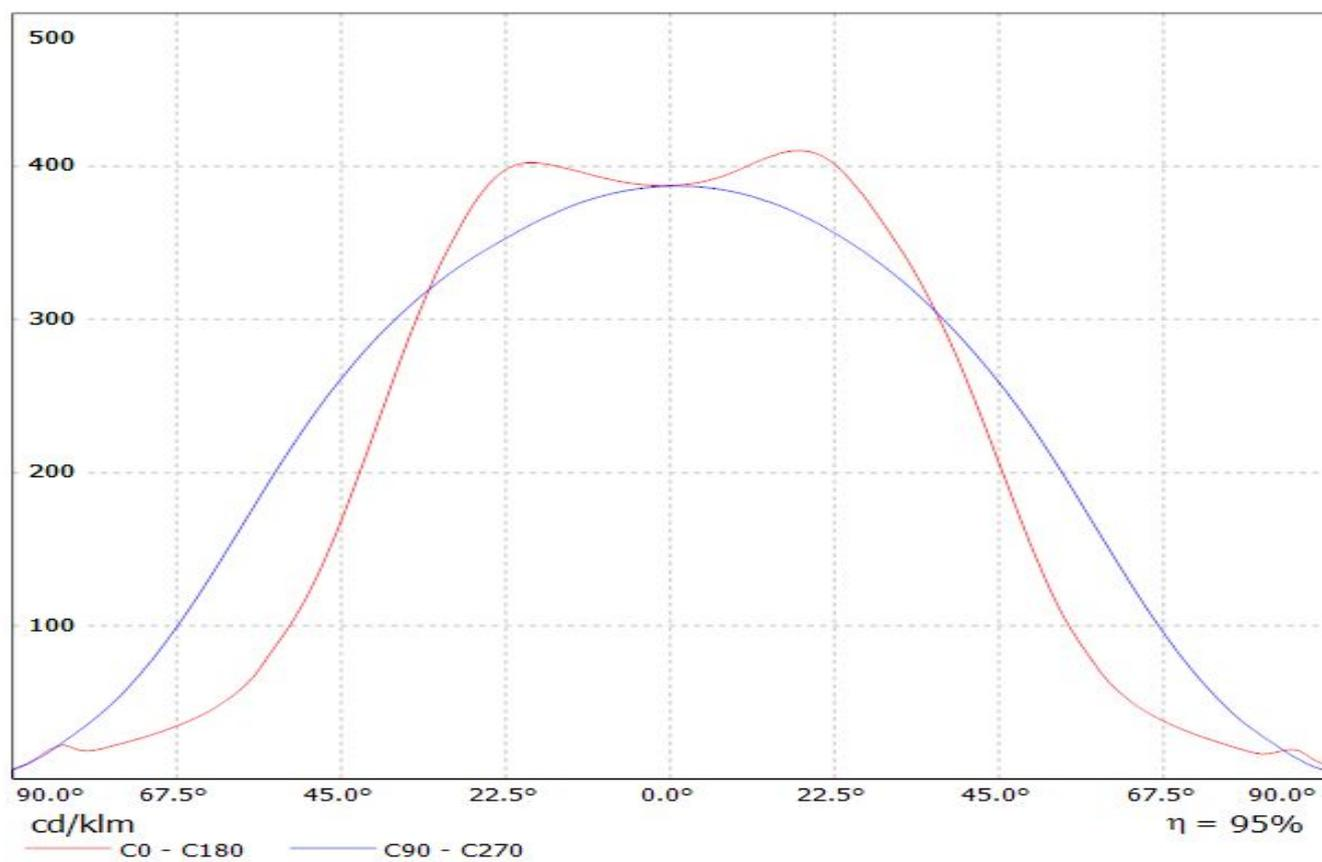

Luminaire: LEDiL Oy F14304_FLORENCE-1R-Z90_(LM302A)

Lamps: 1 x Samsung_LM302A_865.46lm@100mA_P=6.64694W_I=0.1001A

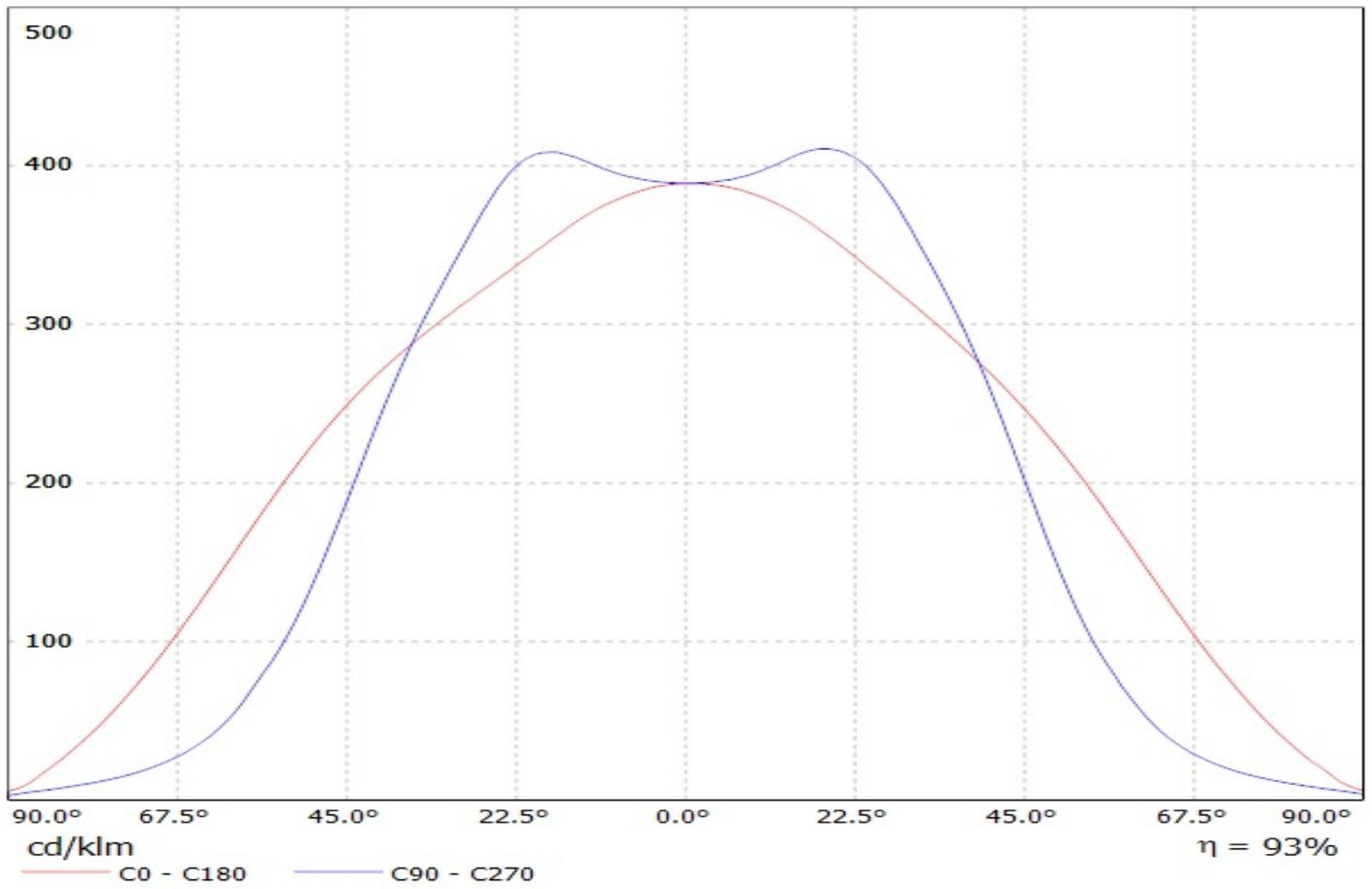

Ledil F14304_FLORENCE-1R-Z90_(LM561B) / LDC (Linear)

Luminaire: Ledil F14304_FLORENCE-1R-Z90_(LM561B)

Lamps: 1 x Samsung_LM561B_x22_348.84lm@65mA_P=1.97W_I=65mA

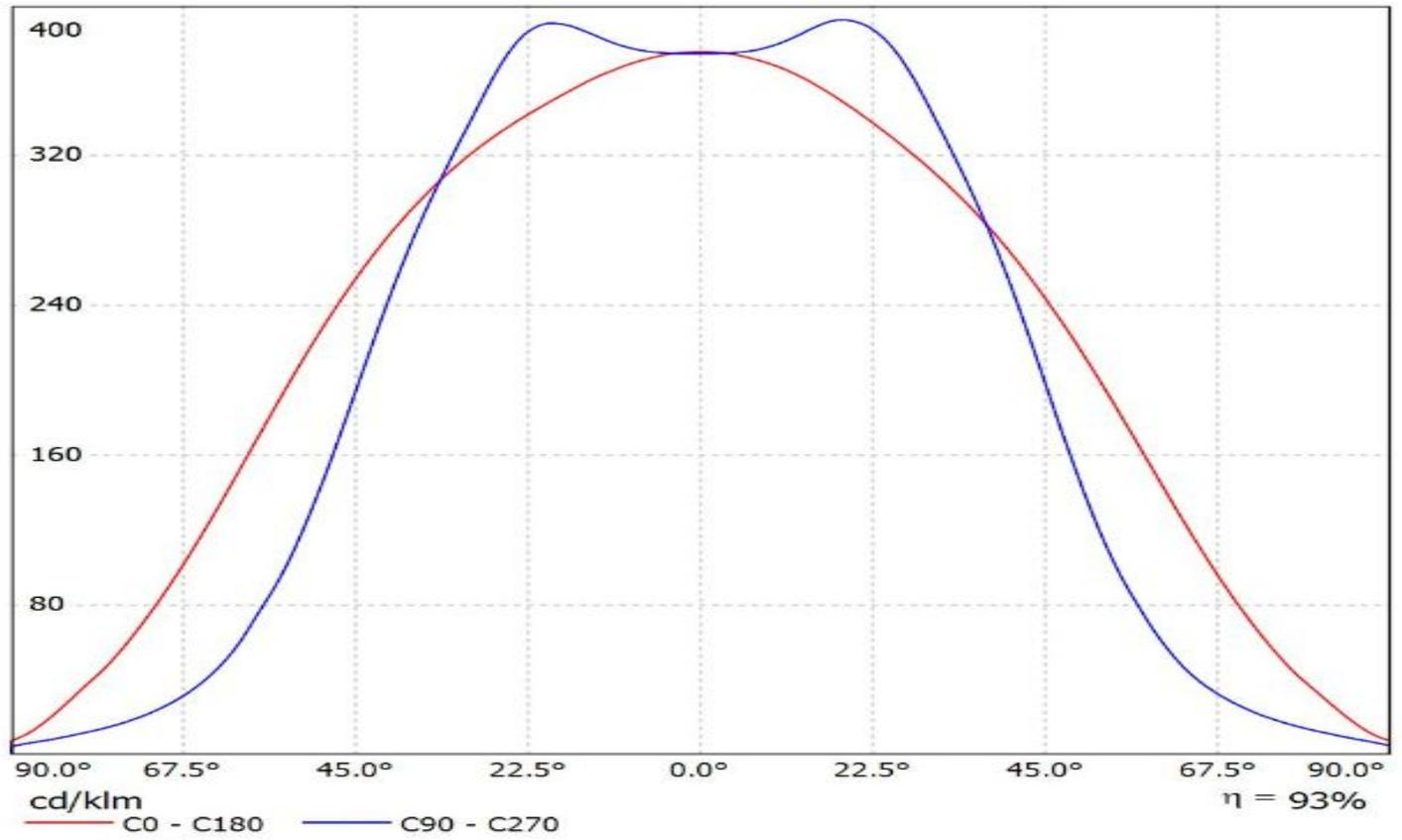

Luminaire: Ledil F14304_FLORENCE-1R-Z90_(LM301A)

Lamps: 1 x Samsung_LM301A_x11_(SPMWHT328FD5WAT0S0)_1087.4lm@250mA_P=8.1922W_I=0.25A

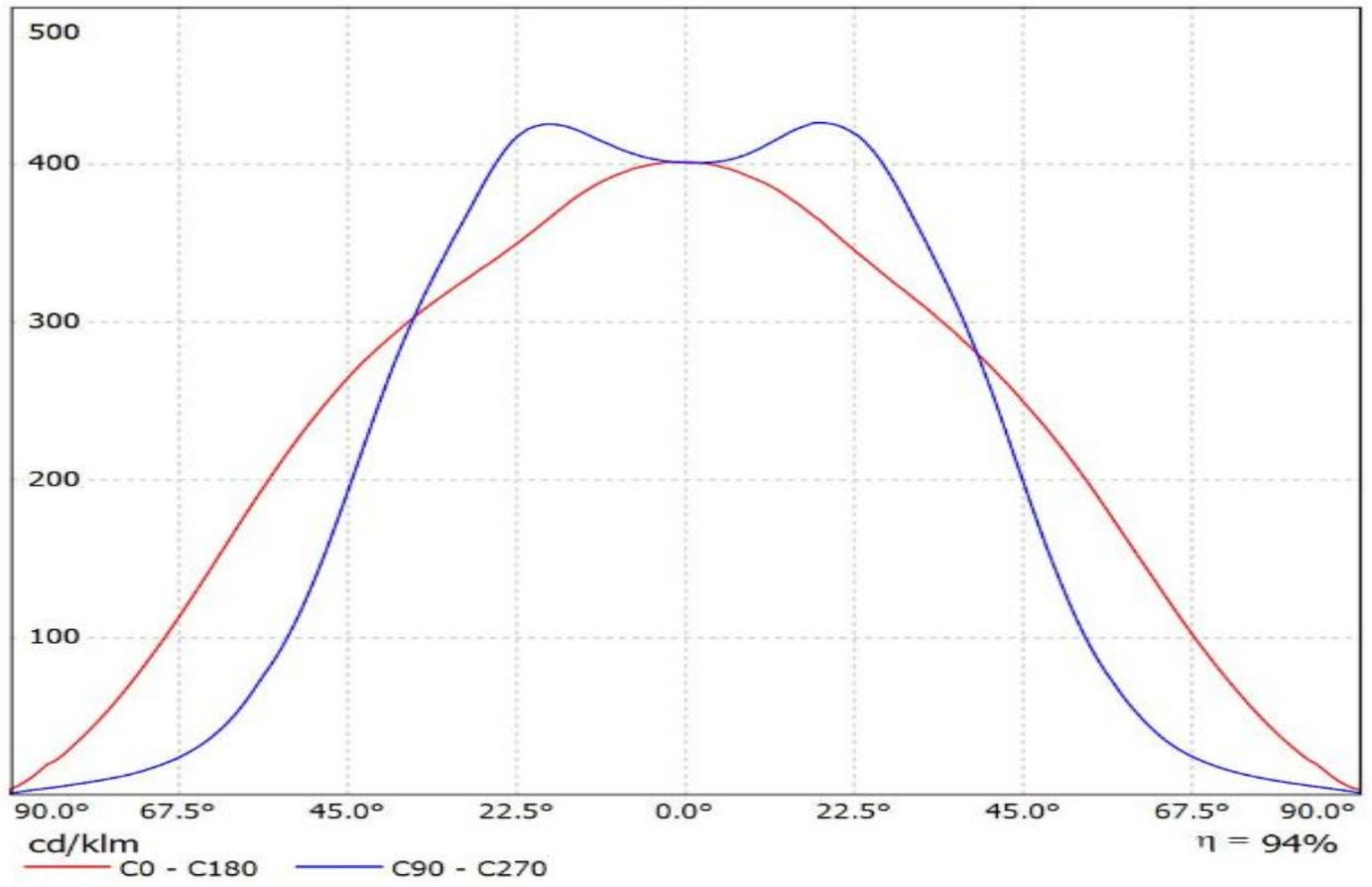

Luminaire: Ledil F14304_FLORENCE-1R-Z90_(LT-S282N)

Lamps: 1 x Samsung SI-B8T071280LD_LM5618+_1401.55lm@250mA_P=9.185W_I=0.25A

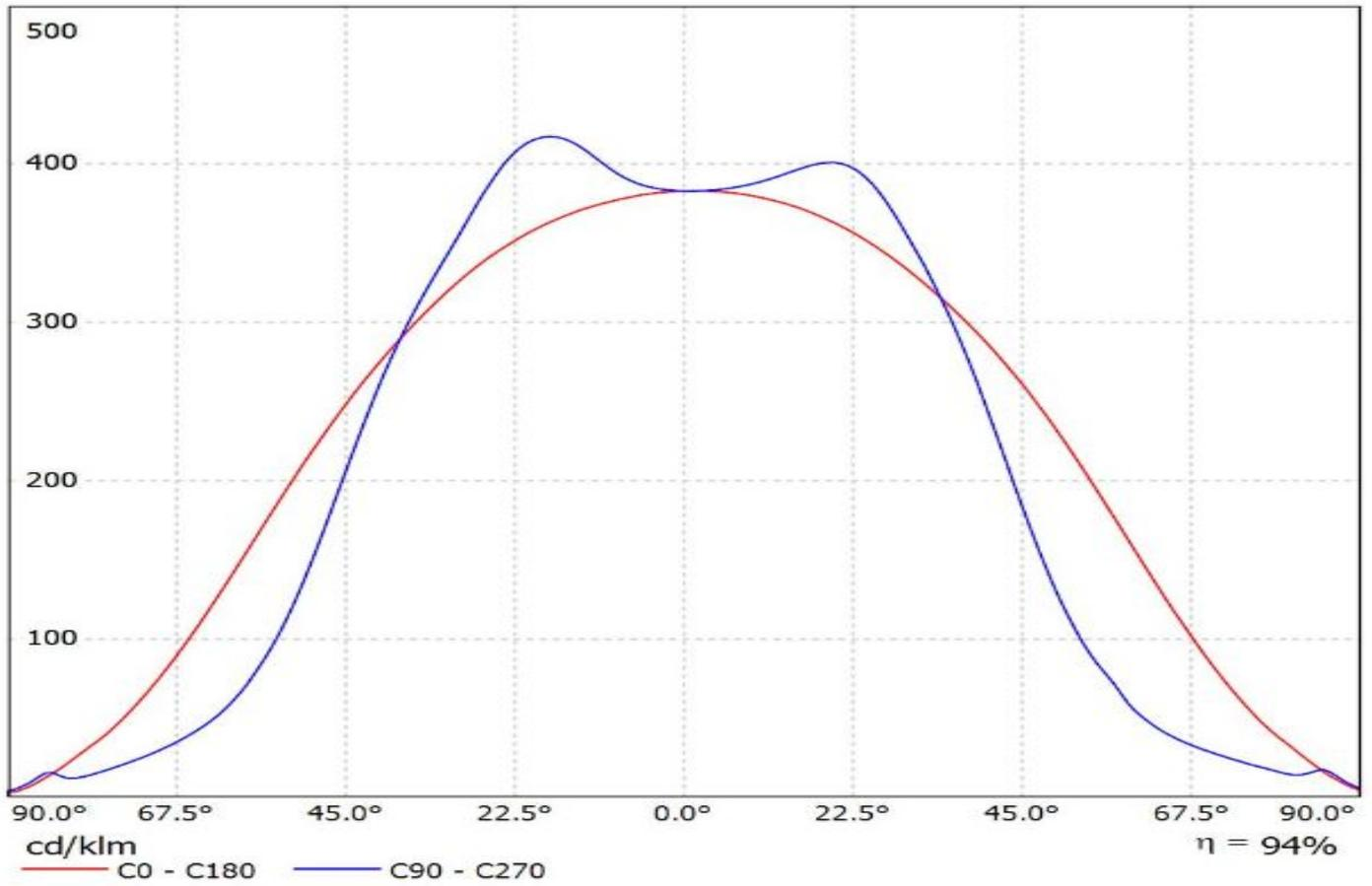

Luminaire: LEDiL Oy F14304_FLORENCE-1R-Z90_(LM561C)
Lamps: 1 x Samsung_LM561C_688.201lm@130mA_P=3.9390W_I=0.130A

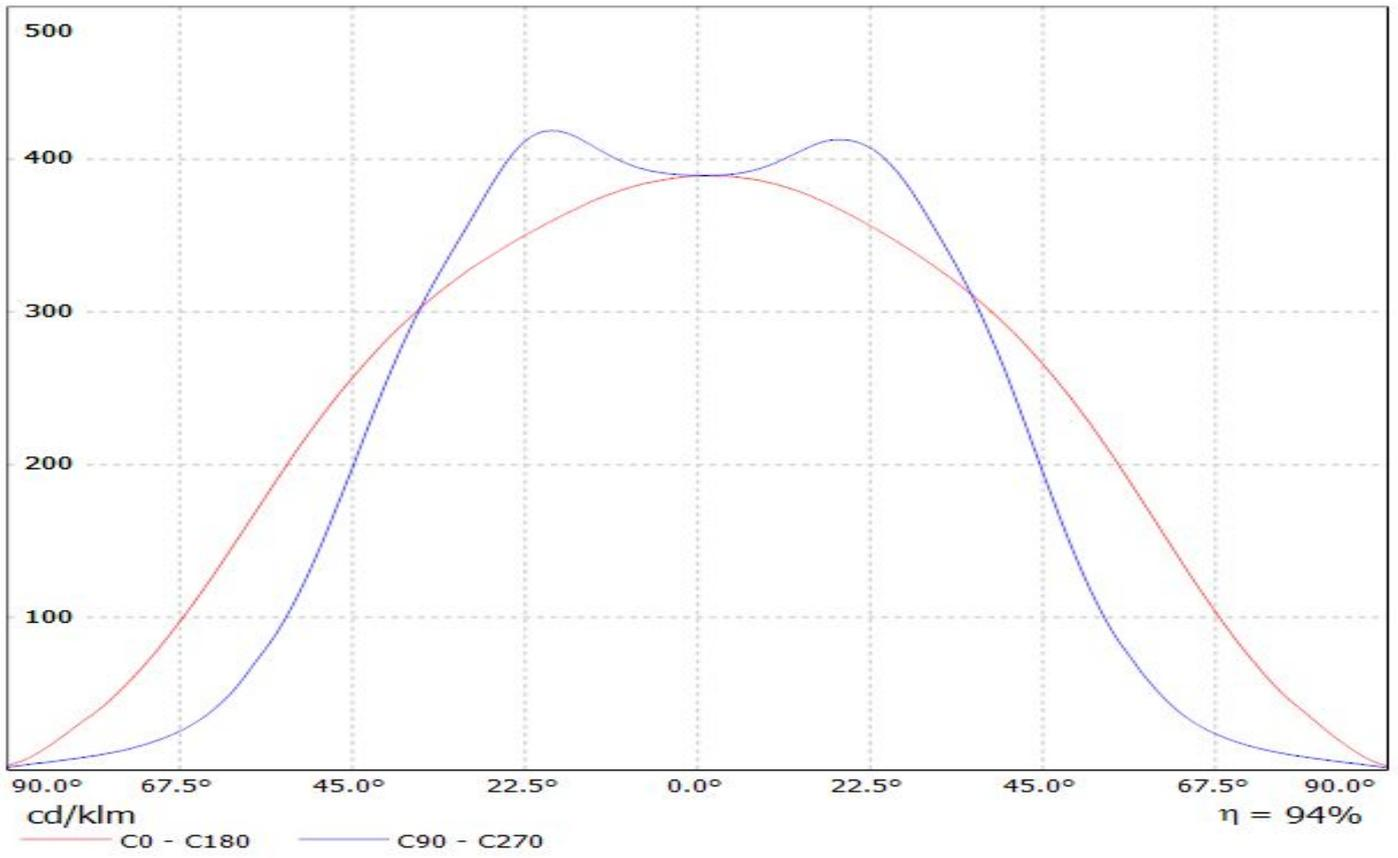

Luminaire: LEDiL Oy F14304_FLORENCE-1R-Z90_(LM281B)
Lamps: 1 x Samsung_LM281B_1309.14lm@300mA_P=10.244W_I=0.300A

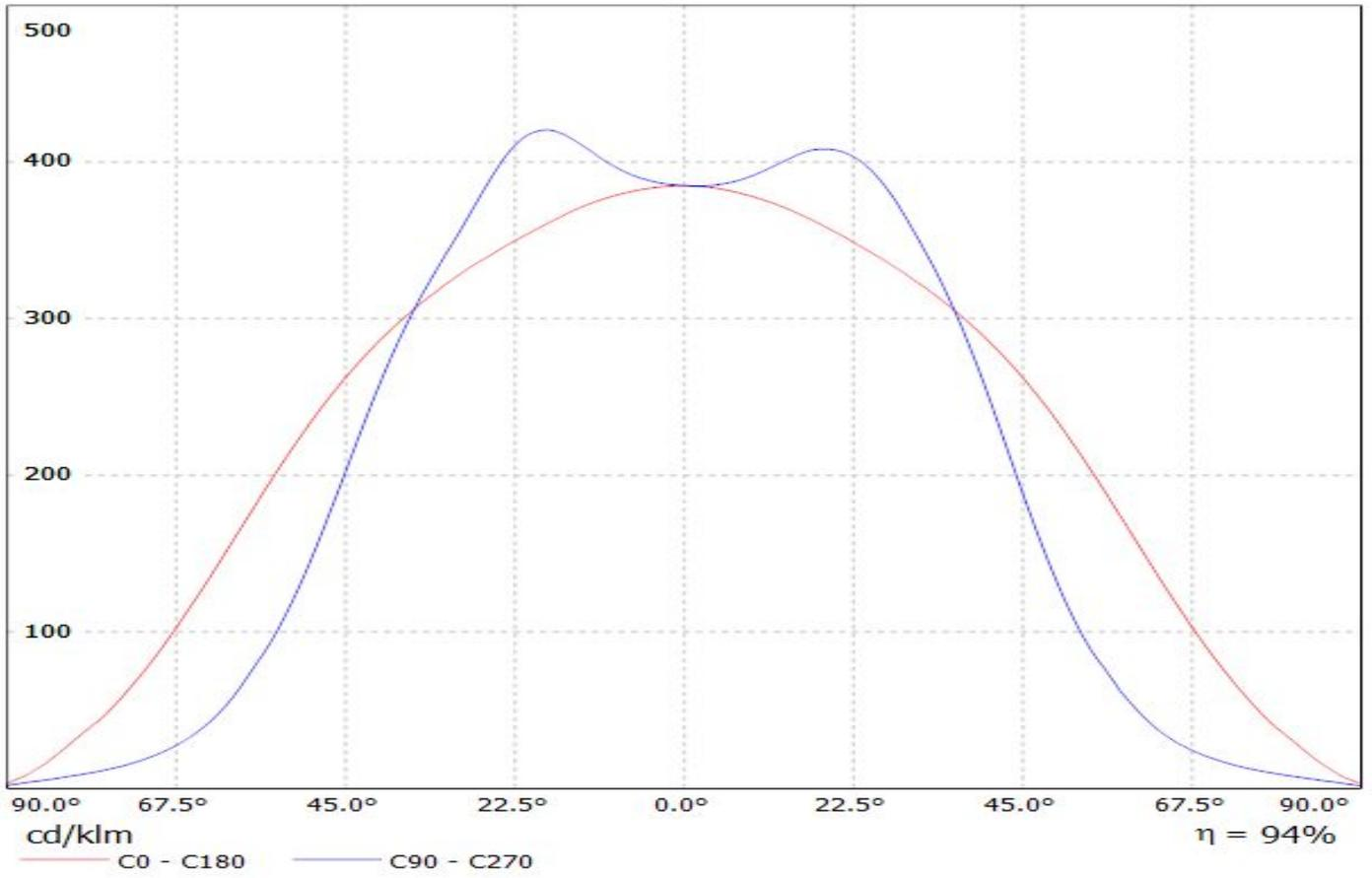

Ledil F14304_FLORENCE-1R-Z90_(Seoul_3030) / LDC (Linear)

Luminaire: Ledil F14304_FLORENCE-1R-Z90_(Seoul_3030)

Lamps: 1 x Seoul_3030_x11_(STW8C2SA)_785.296lm@100mA_P=6.5W_I=0.1A

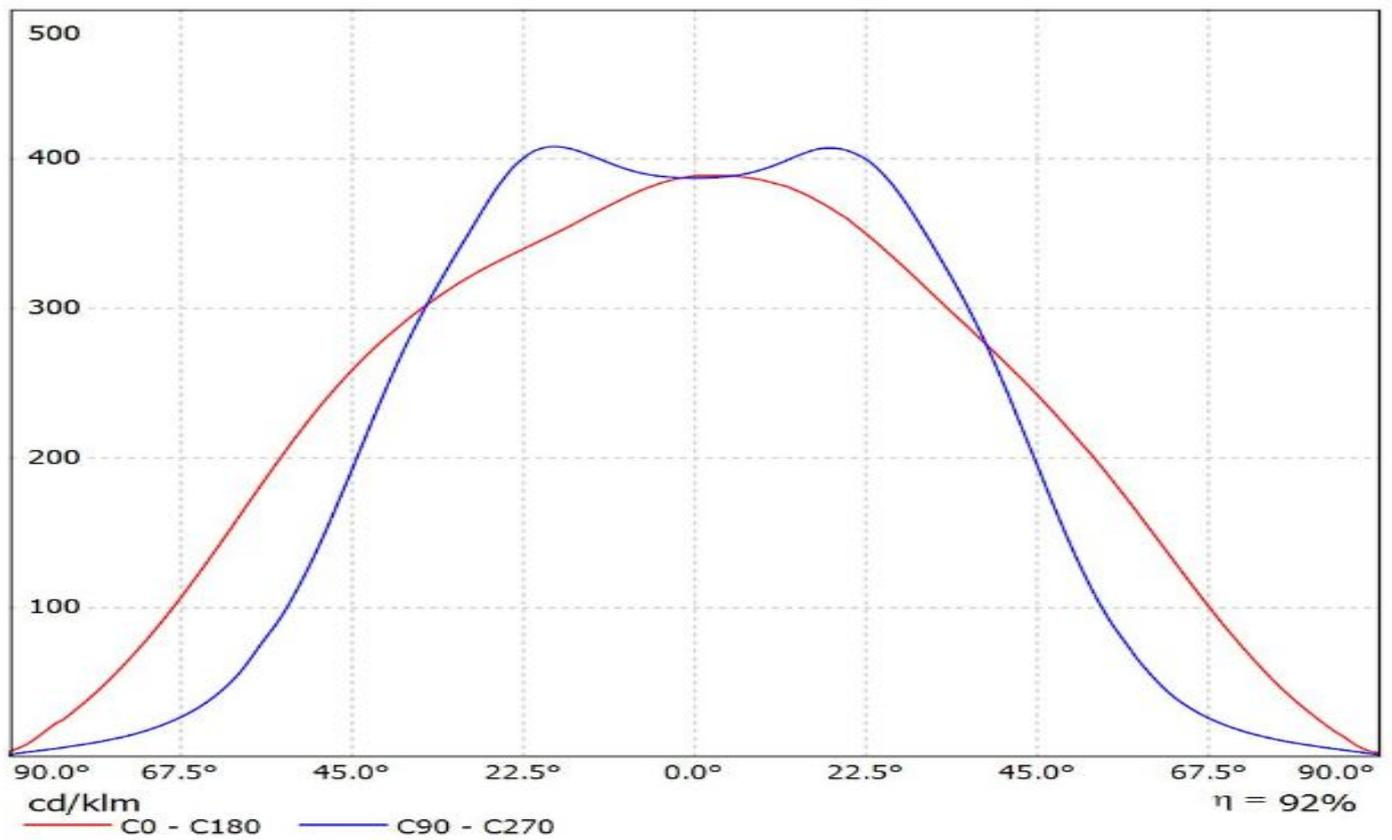

Luminaire: Ledil F14304_FLORENCE-1R-Z90_(CALGD0414-M8W1)

Lamps: 1 x Citizen_CALGD0414-M8W1_556.672lm@350mA_P=4.0291W_I=0.3499A

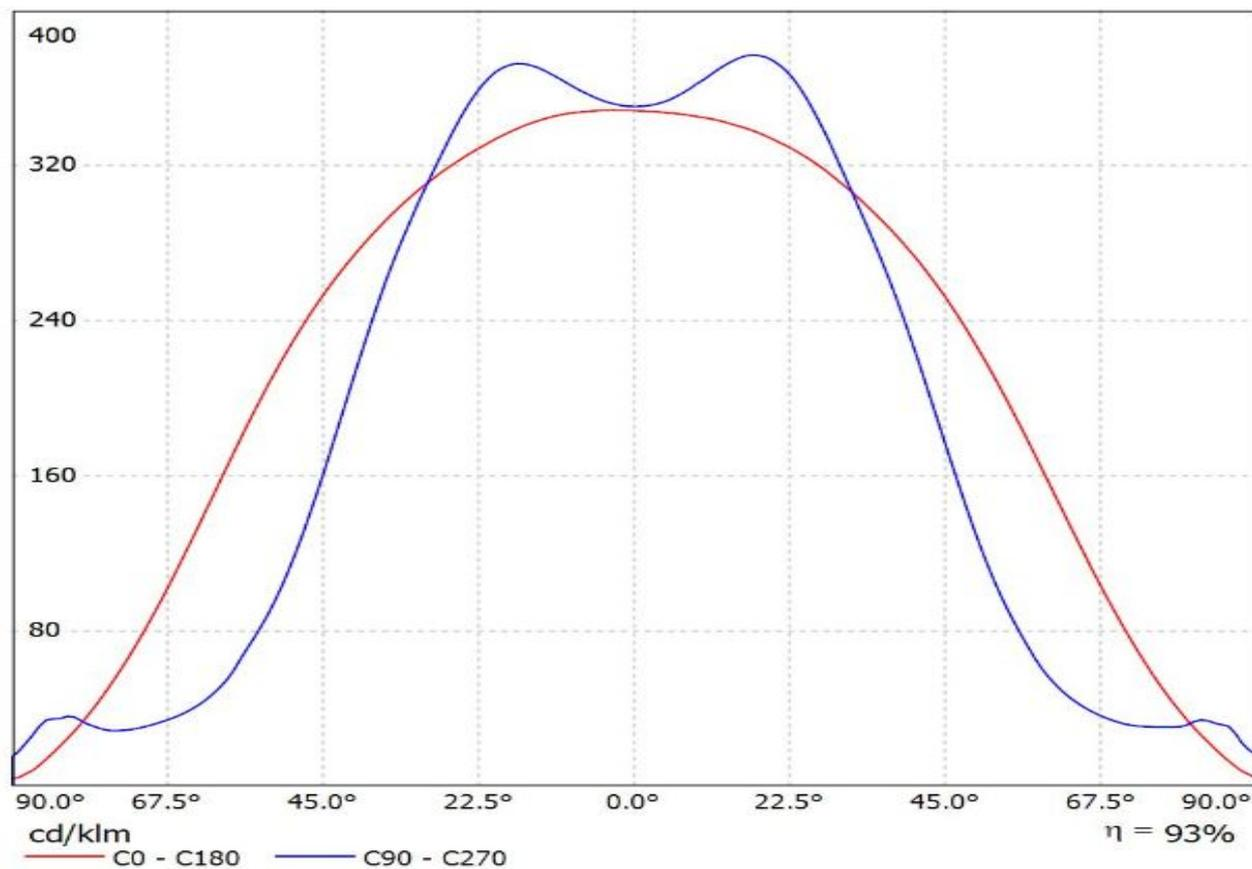

Luminaire: Ledil F14304_FLORENCE-1R-Z90_(CALGD0814-M17W1)
Lamps: 1 x Citizen_(CALGD0814-M17W1)_1098.26lm@350mA_P=7.96302W_η=0.3499A

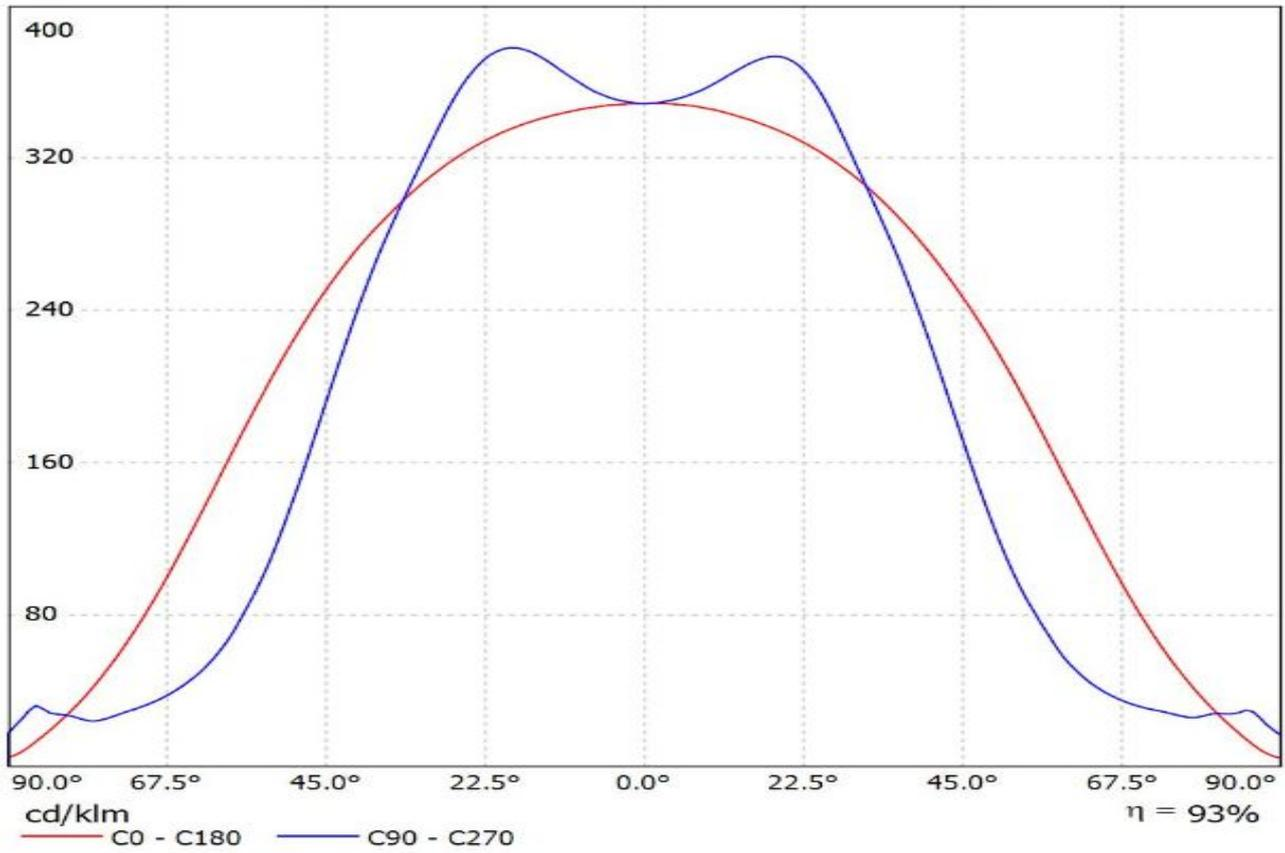

Luminaire: Ledil F14304_FLORENCE-1R-Z90_(CeZos)

Lamps: 1 x CeZos_(L0-280024-xxx-C0800-L267)_1346.29lm@250mA_CCT=3000K_P=8.5017W_I=0.25A

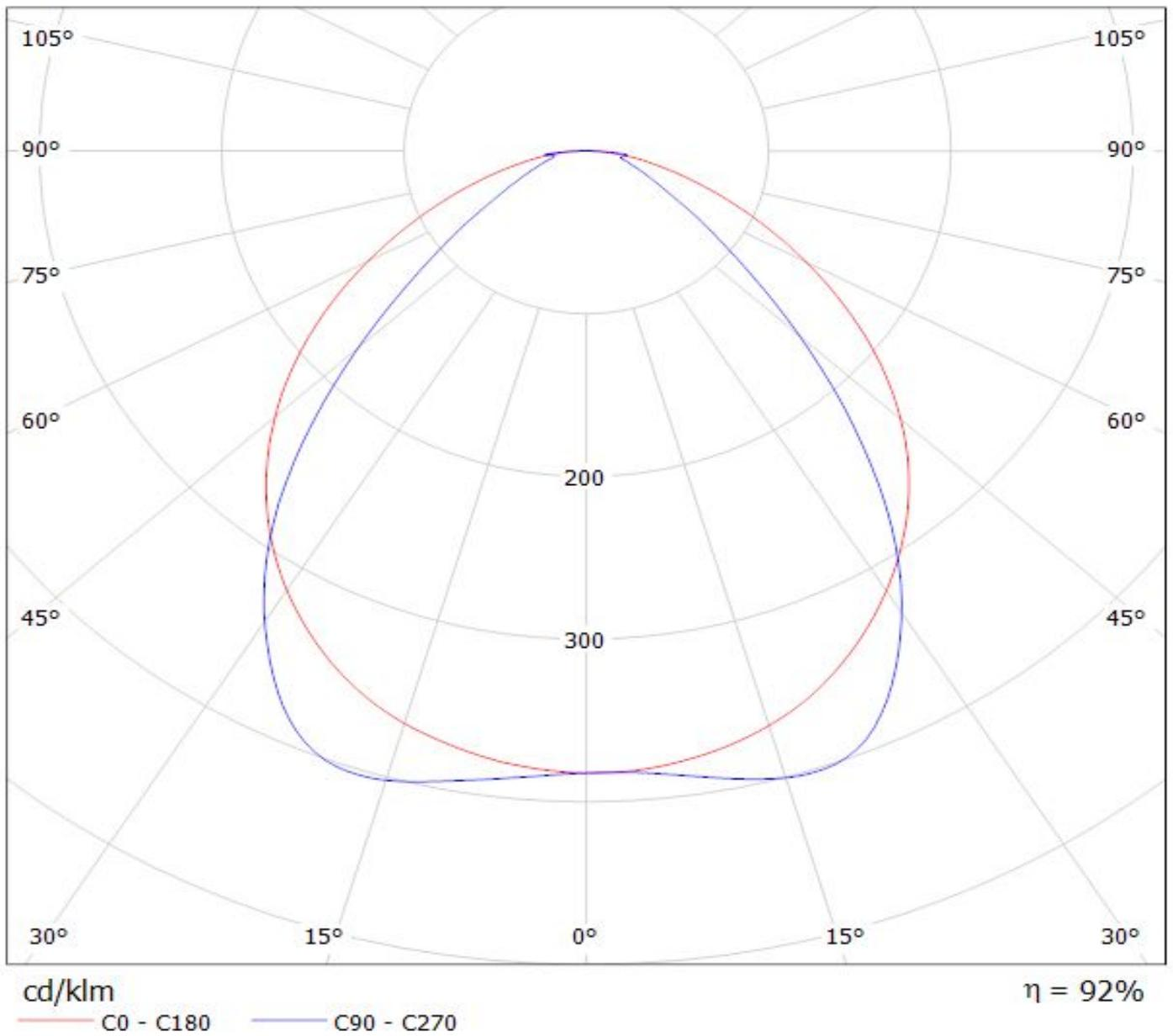

Ledil F14304_FLORENCE-1R-Z90_(XH-B) / LDC (Polar)

Luminaire: Ledil F14304_FLORENCE-1R-Z90_(XH-B)

Lamps: 1 x Cree_XH-B_x22_(XHBAAWT-0-7B4-J20-0H-0001)_315.848lm@65mA_P=2.11W_I=65mA

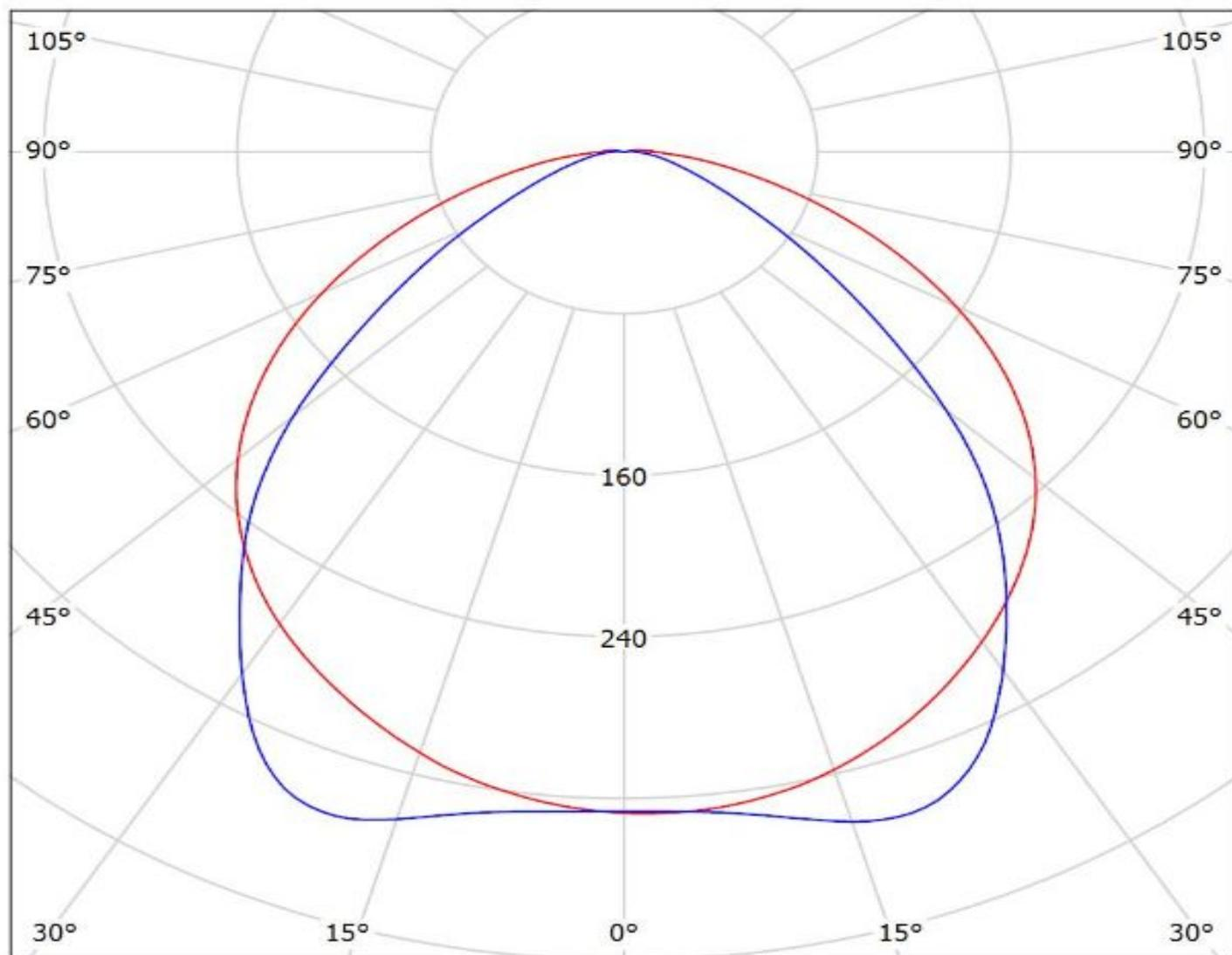

cd/klm

— C0 - C180 — C90 - C270

$\eta = 90\%$

Ledil F14304_FLORENCE-1R-Z90_(Luxeon_3535_2D) / LDC (Polar)

Luminaire: Ledil F14304_FLORENCE-1R-Z90_(Luxeon_3535_2D)

Lamps: 1 x Luxeon_3535_2D_x22_(MXC8_4000K)_910.245lm@100mA_CCT=4000K_P=6.32W_I=0.1A

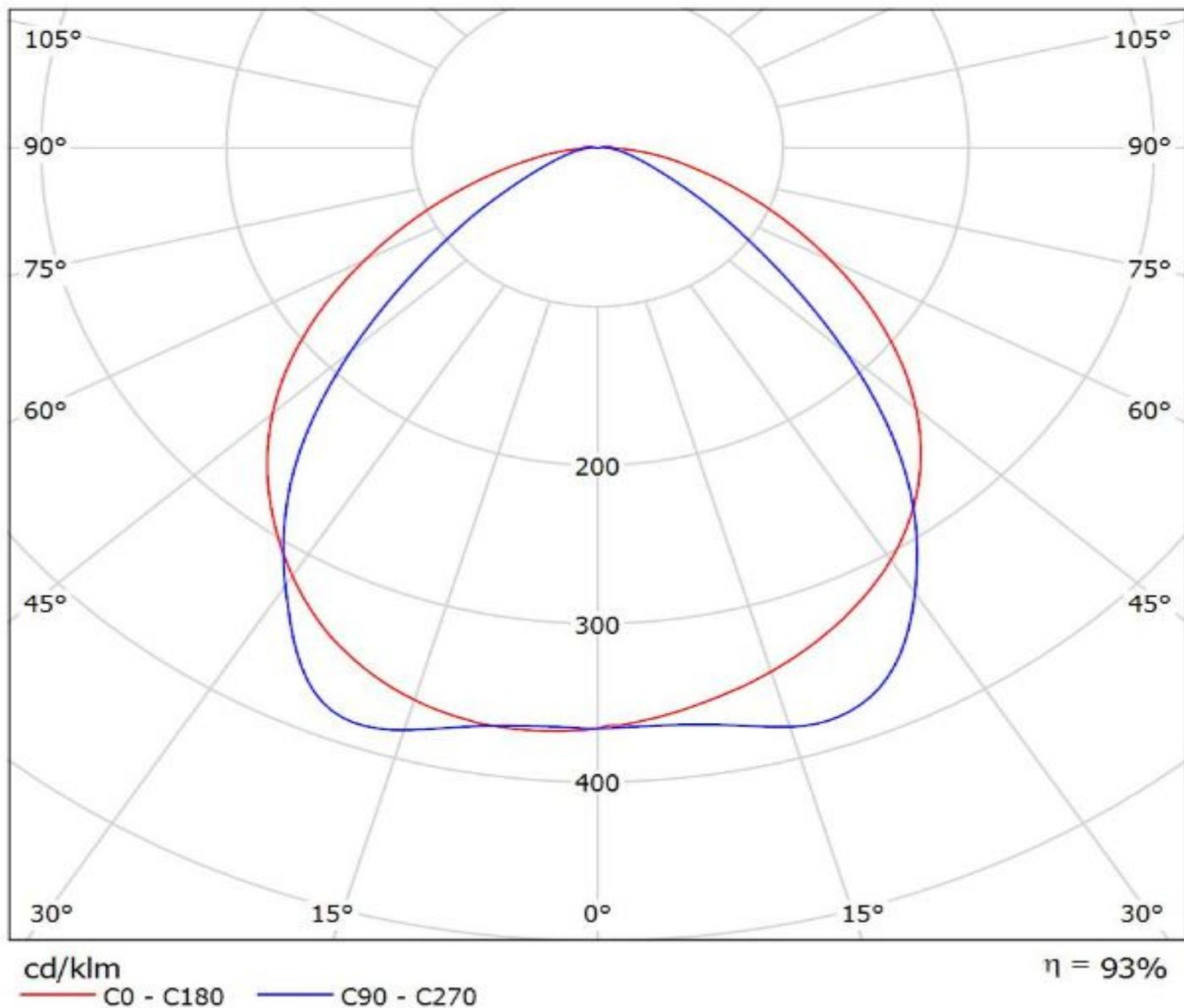

Ledil F14304_FLORENCE-1R-Z90_(Luxeon_3030_2D) / LDC (Polar)

Luminaire: Ledil F14304_FLORENCE-1R-Z90_(Luxeon_3030_2D)

Lamps: 1 x Luxeon_3030_2D_x22_(L130-4080003000W21)

_1601.44lm@200mA_CCT=4000K_P=12.8W_I=0.2A

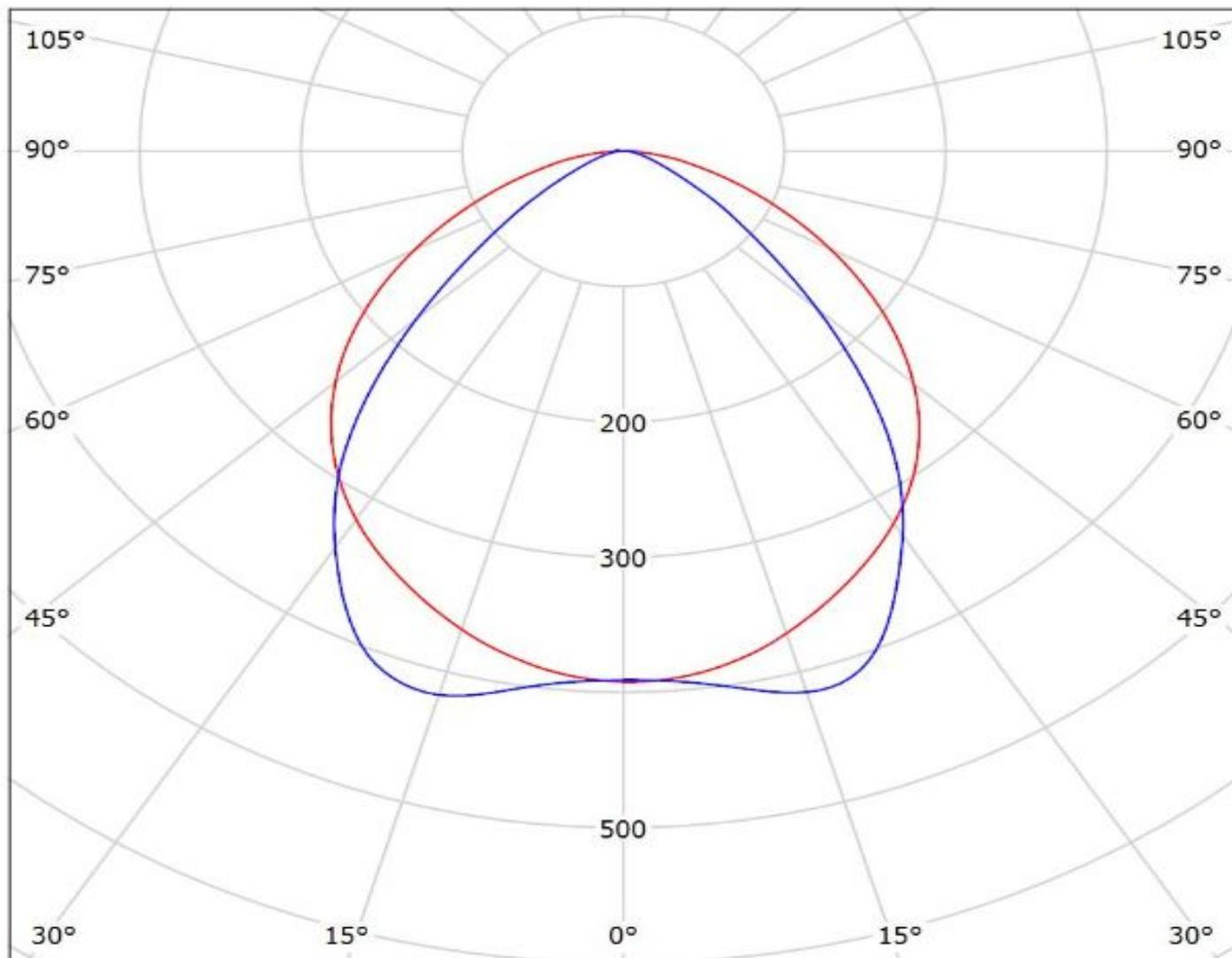

cd/klm

— C0 - C180 — C90 - C270

$\eta = 92\%$

Luminaire: Ledil F14304_FLORENCE-1R-Z90_(3014_x22)

Lamps: 1 x Luxeon_3014_x22_(L130-5080)_282.652lm@60mA_P=1.9076W_I=0.060mA

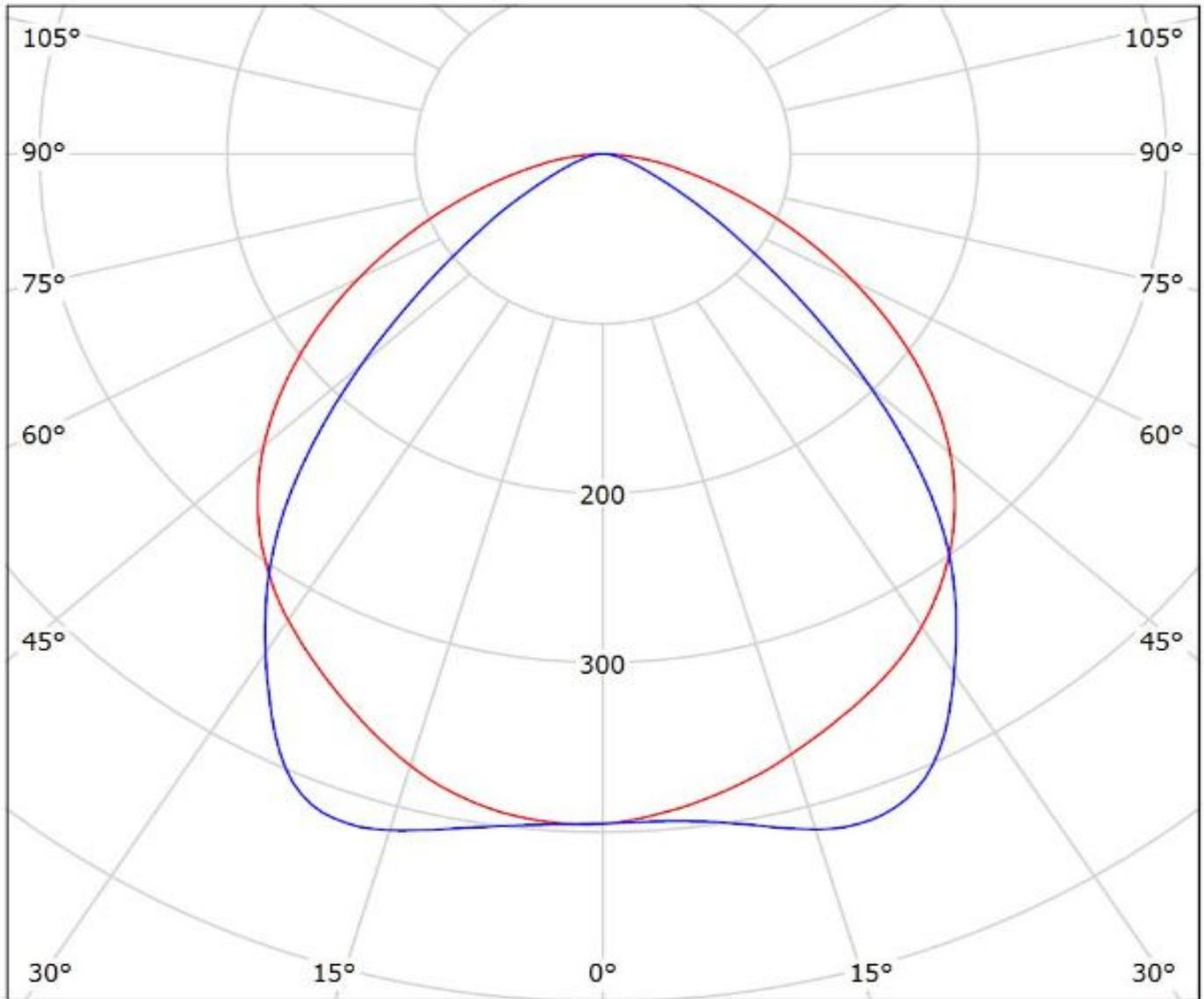

cd/klm

— C0 - C180 — C90 - C270

$\eta = 94\%$

Luminaire: Ledil F14304_FLORENCE-1R-Z90_(3535L_x22)

Lamps: 1 x Luxeon_3535L_x22_(MXA8-PW50)_507.681lm@100mA_P=2.9953W_I=0.100mA

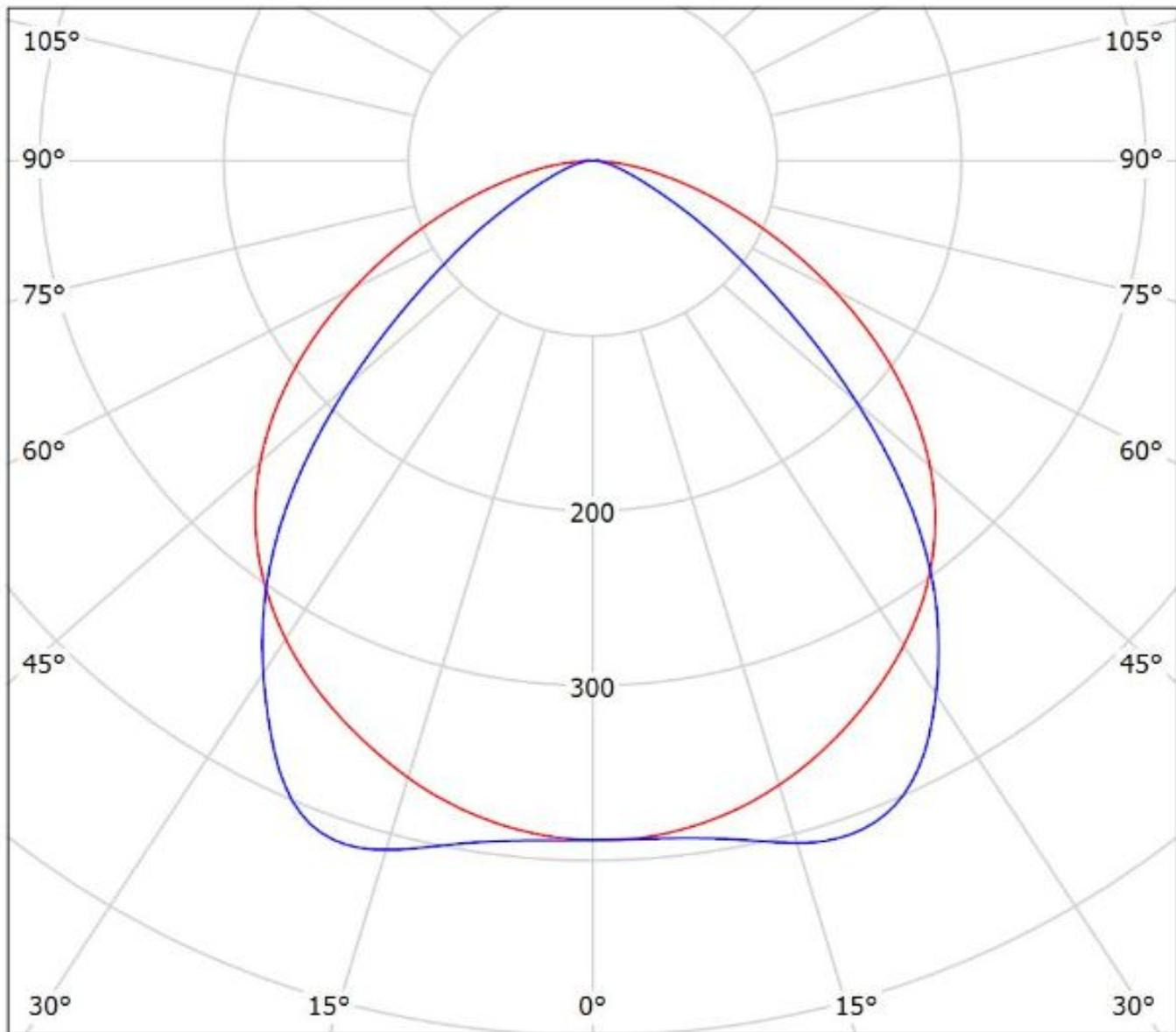

cd/klm

— C0 - C180 — C90 - C270

$\eta = 94\%$

Luminaire: Ledil F14304_FLORENCE-1R-Z90_(3020)

Lamps: 1 x Luxeon_3020_x22_(L130-2780)_488.066lm@120mA_P=3.7731W_I=0.120mA

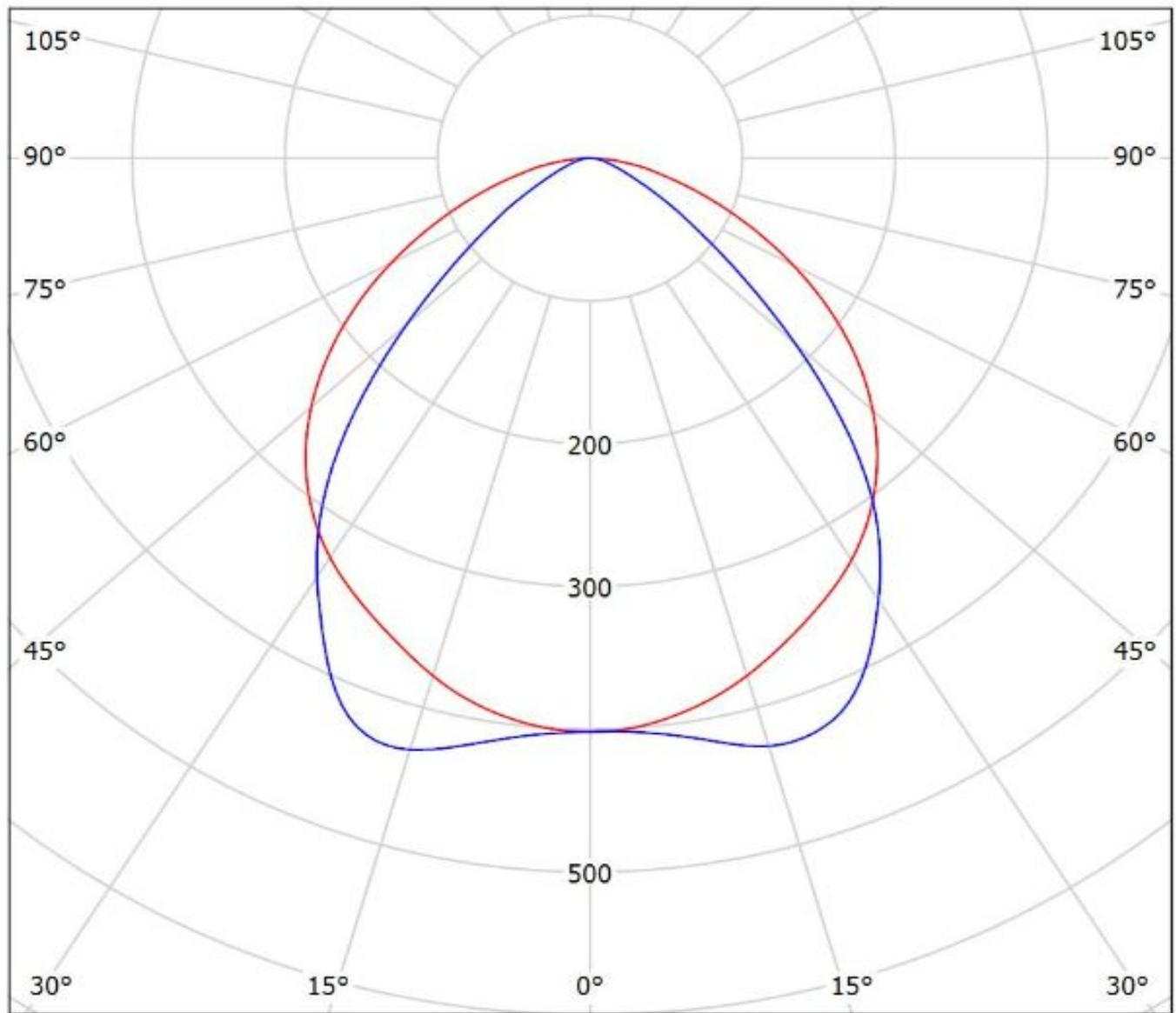

cd/klm

— C0 - C180 — C90 - C270

$\eta = 94\%$

Ledil F14304_FLORENCE-1R-Z90_(Luminus_MP-2016) / LDC (Polar)

Luminaire: Ledil F14304_FLORENCE-1R-Z90_(Luminus_MP-2016)

Lamps: 1 x Luminus_MP-2016_1x22_(LUMMP-1100-30-80)_471.904lm@120mA_P=4W_η=0.12A

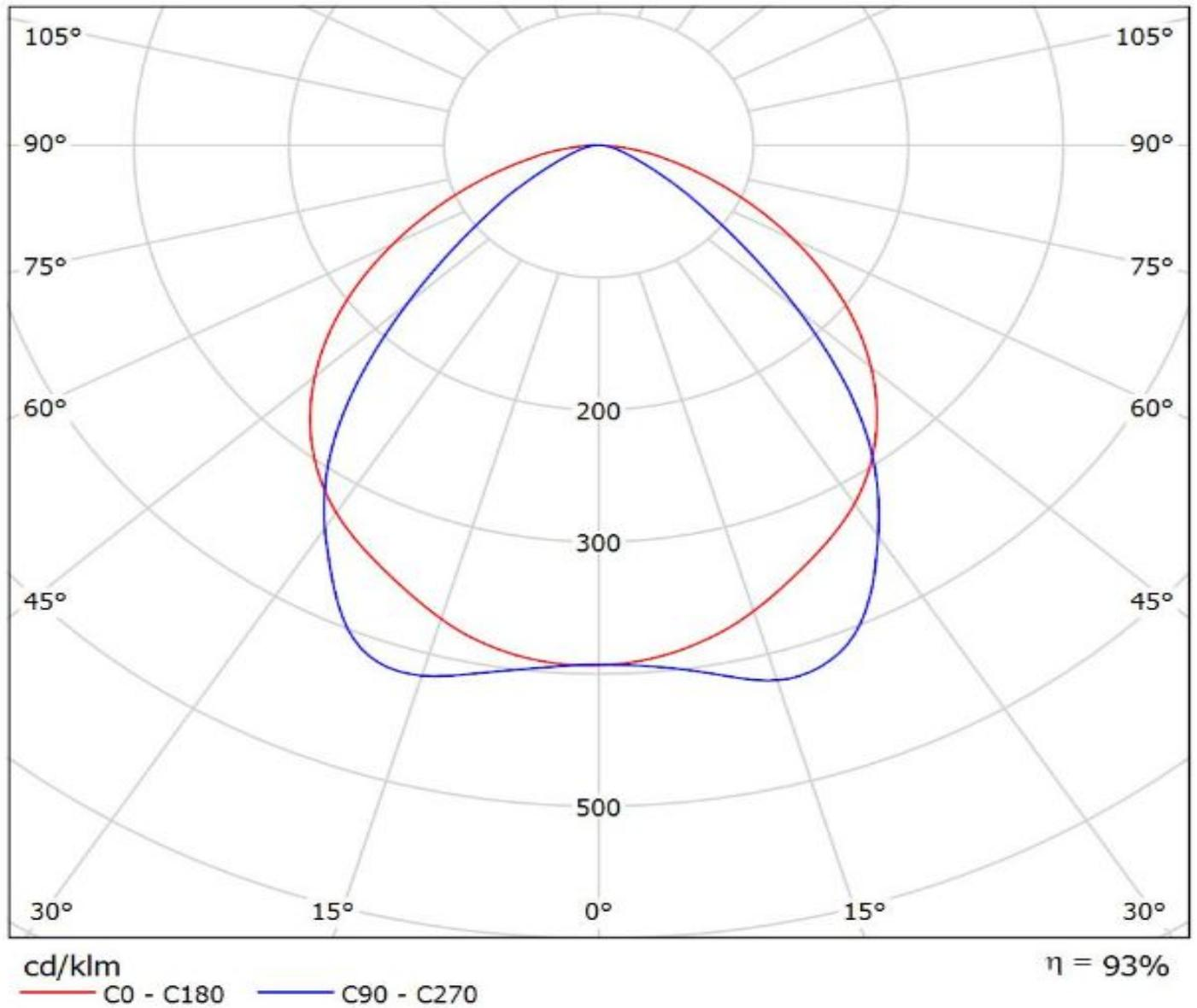

Ledil F14304_FLORENCE-1R-Z90_(NF2x757D) / LDC (Polar)

Luminaire: Ledil F14304_FLORENCE-1R-Z90_(NF2x757D)

Lamps: 1 x Nichia_NF2x757D_2chip_x22 (NF2W757DRT)_2050.61lm@200mA_P=12.95W_I=0.2A

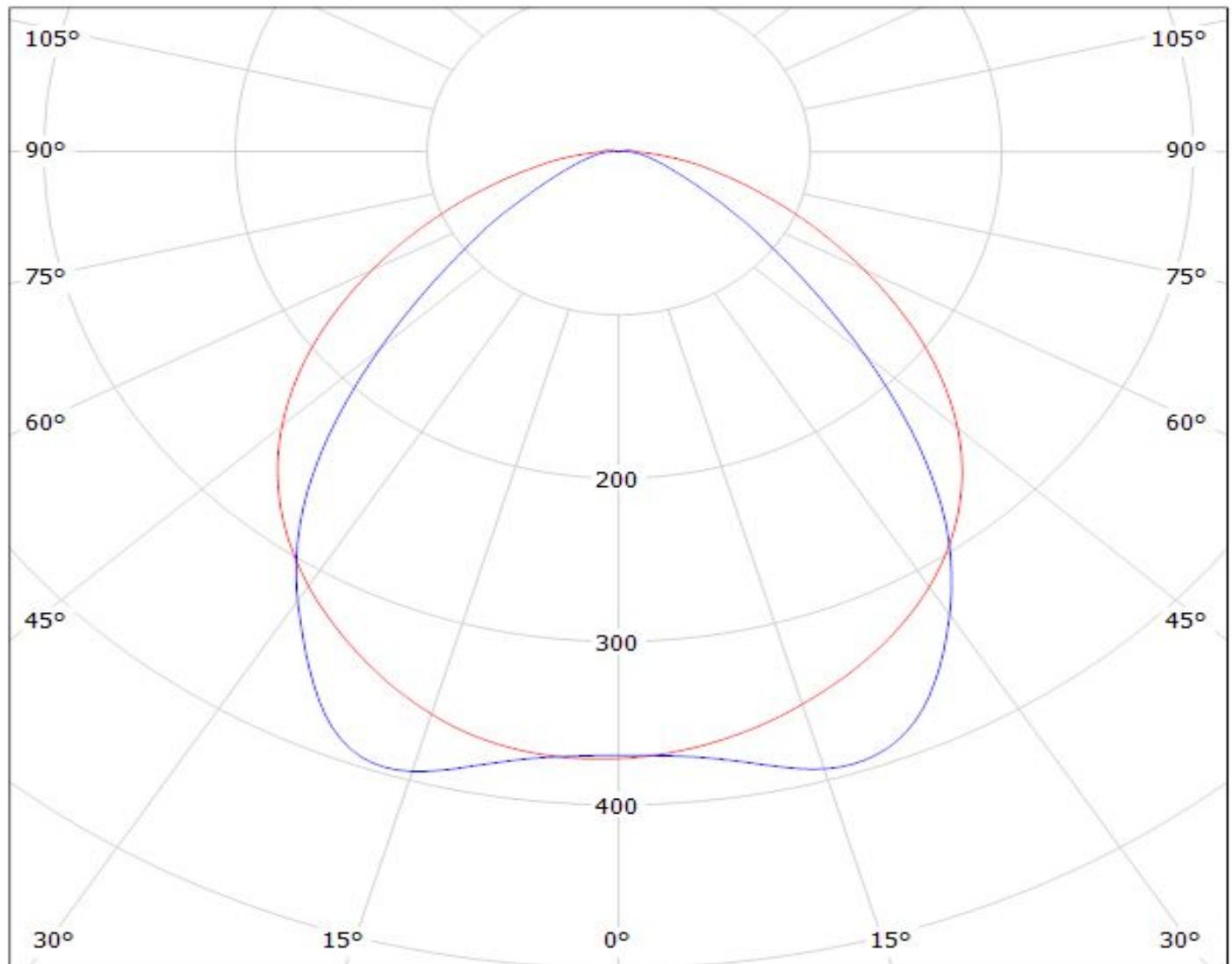

Luminaire: Ledil F14304_FLORENCE-1R-Z90_(NF2W757G)

Lamps: 1 x NF2W757G_377.885lm@65mA_CCT=?K_P=1.97W_I=0.065A

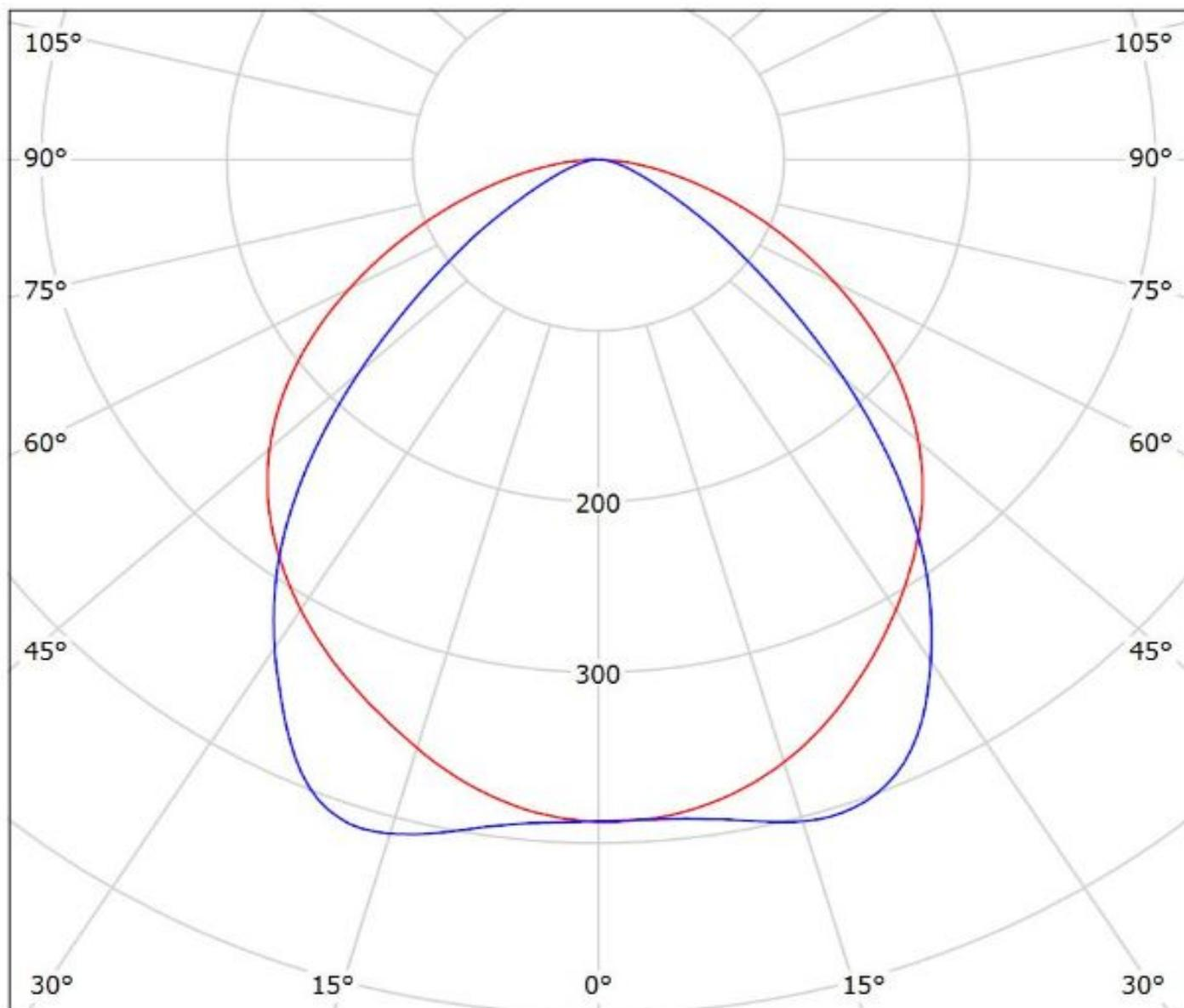

cd/klm

— C0 - C180 — C90 - C270

$\eta = 92\%$

Luminaire: Ledil F14304_FLORENCE-1R-Z90_(Duris_S5)

Lamps: 1 x Osram_Duris_S5_(GW_PSLRS1.EC-LQLS-5H7I-1)_993.467lm@100mA_P=8W_I=0.1000A

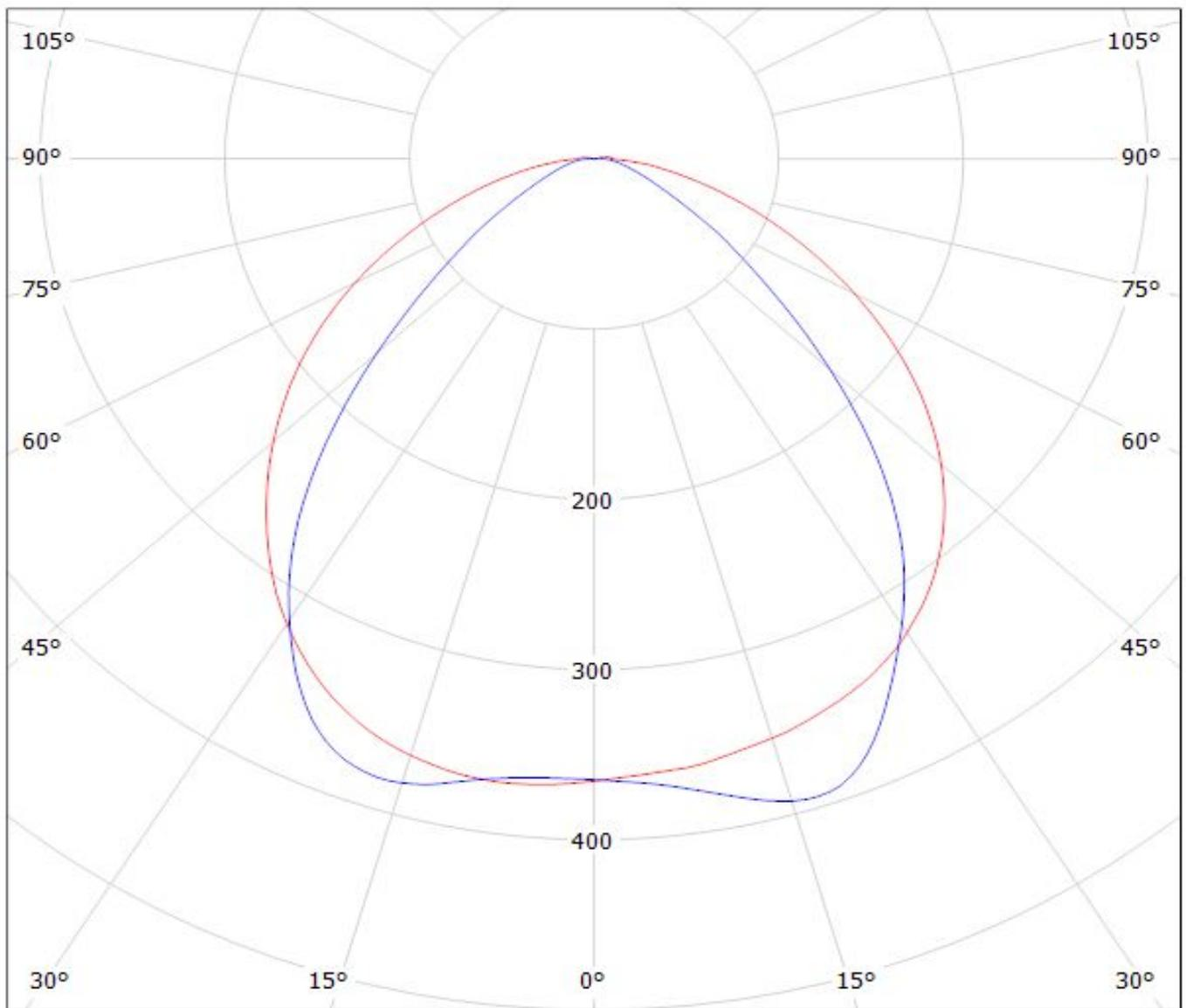

cd/klm

— C0 - C180 — C90 - C270

$\eta = 94\%$

Luminaire: Ledil Oy F14304_FLORENCE-1R-Z90_(Duris_E_2835)_SIMULATED
Lamps: 1 x Osram Duris E 2835 - GW JTLRS1.EM

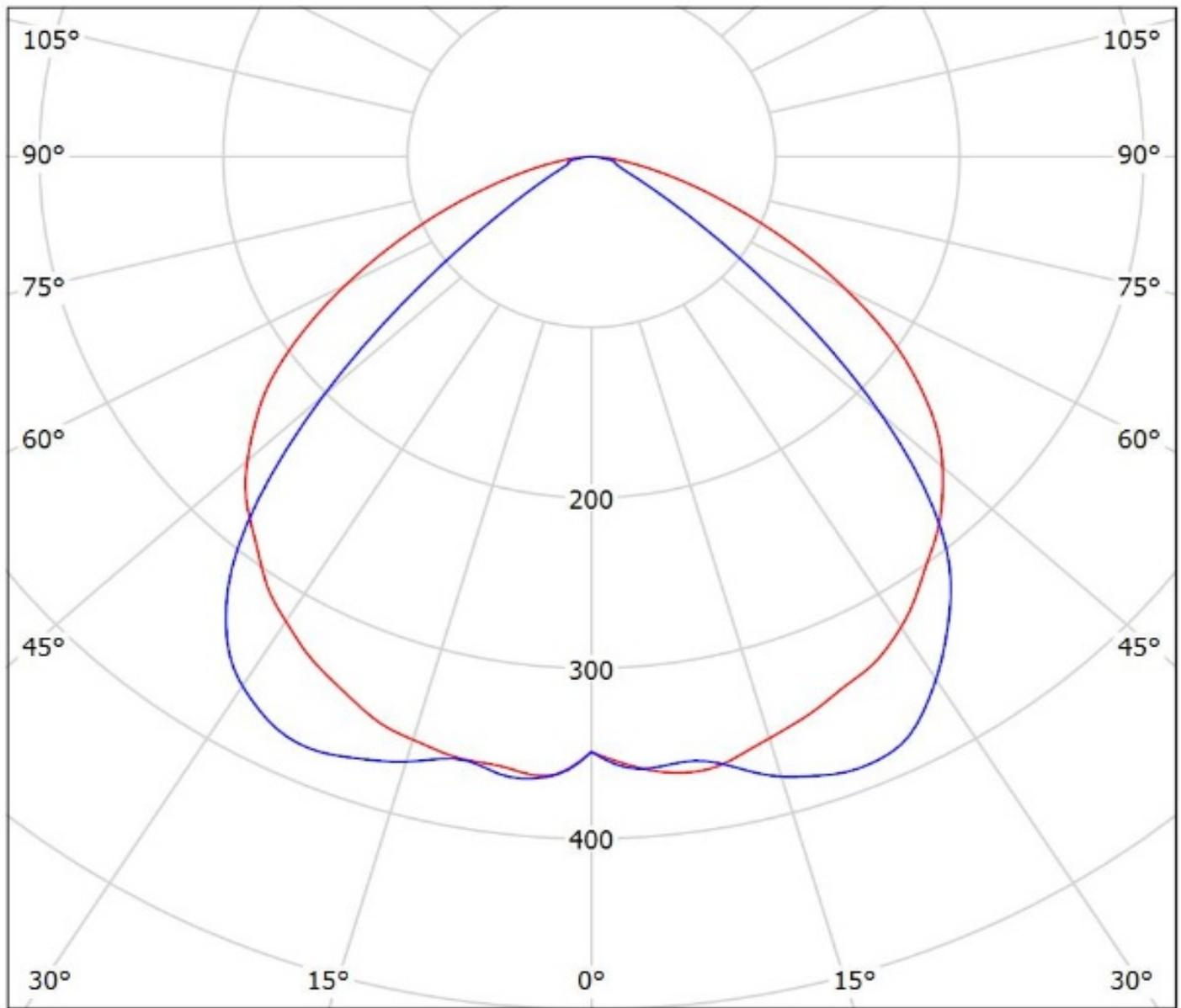

cd/klm

— C0 - C180 — C90 - C270

$\eta = 93\%$

Luminaire: LEDiL Oy F14304_FLORENCE-1R-Z90

Lamps: 1 x Fortimo LED Line 1ft 1100lm 1R_1033.71lm@250mA_P=8.41851W_I=249.8mA

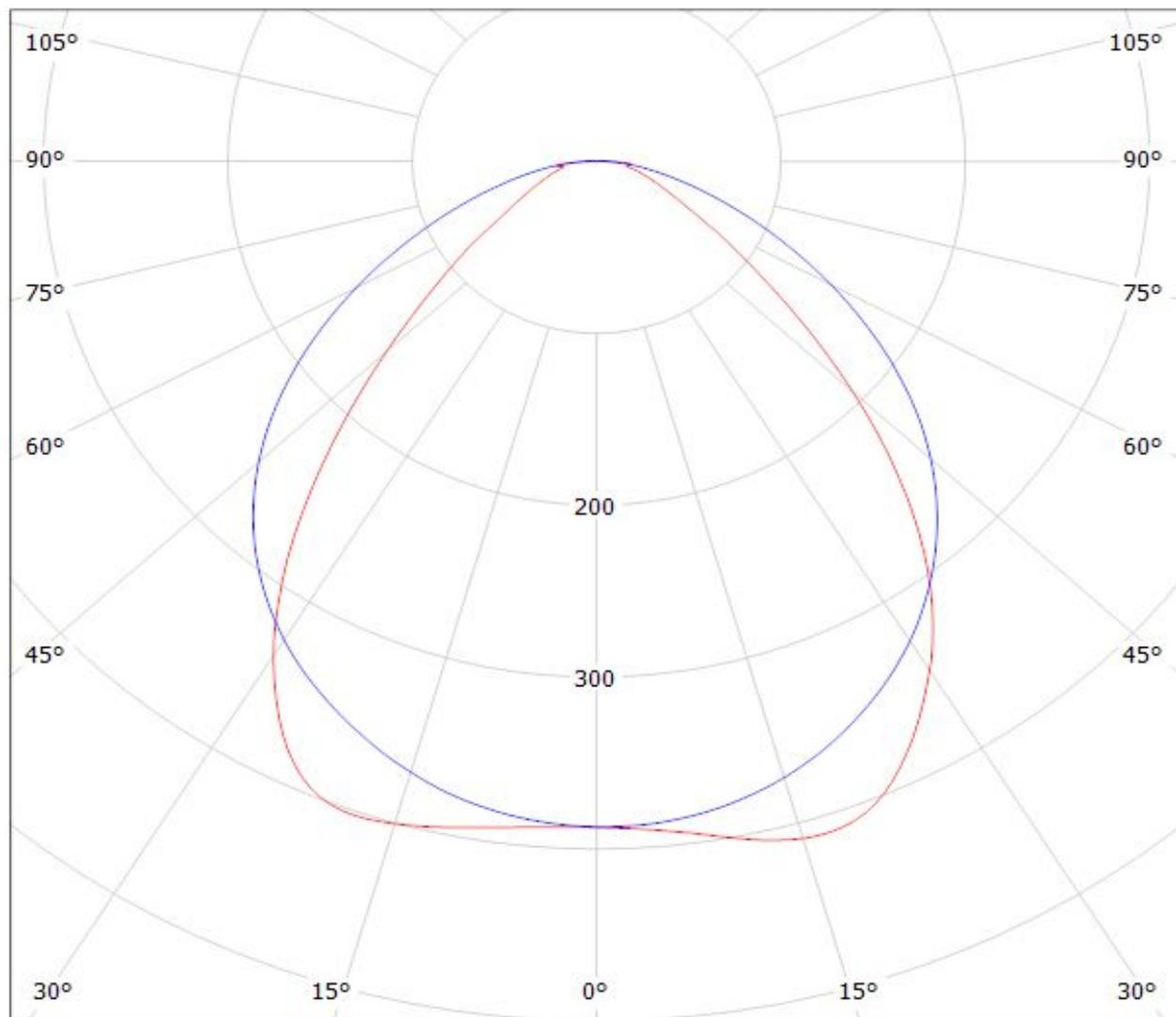

cd/klm

— C0 - C180

— C90 - C270

$\eta = 95\%$

Luminaire: LEDiL Oy F14304_FLORENCE-1R-Z90_(LM302A)

Lamps: 1 x Samsung_LM302A_865.46lm@100mA_P=6.64694W_I=0.1001A

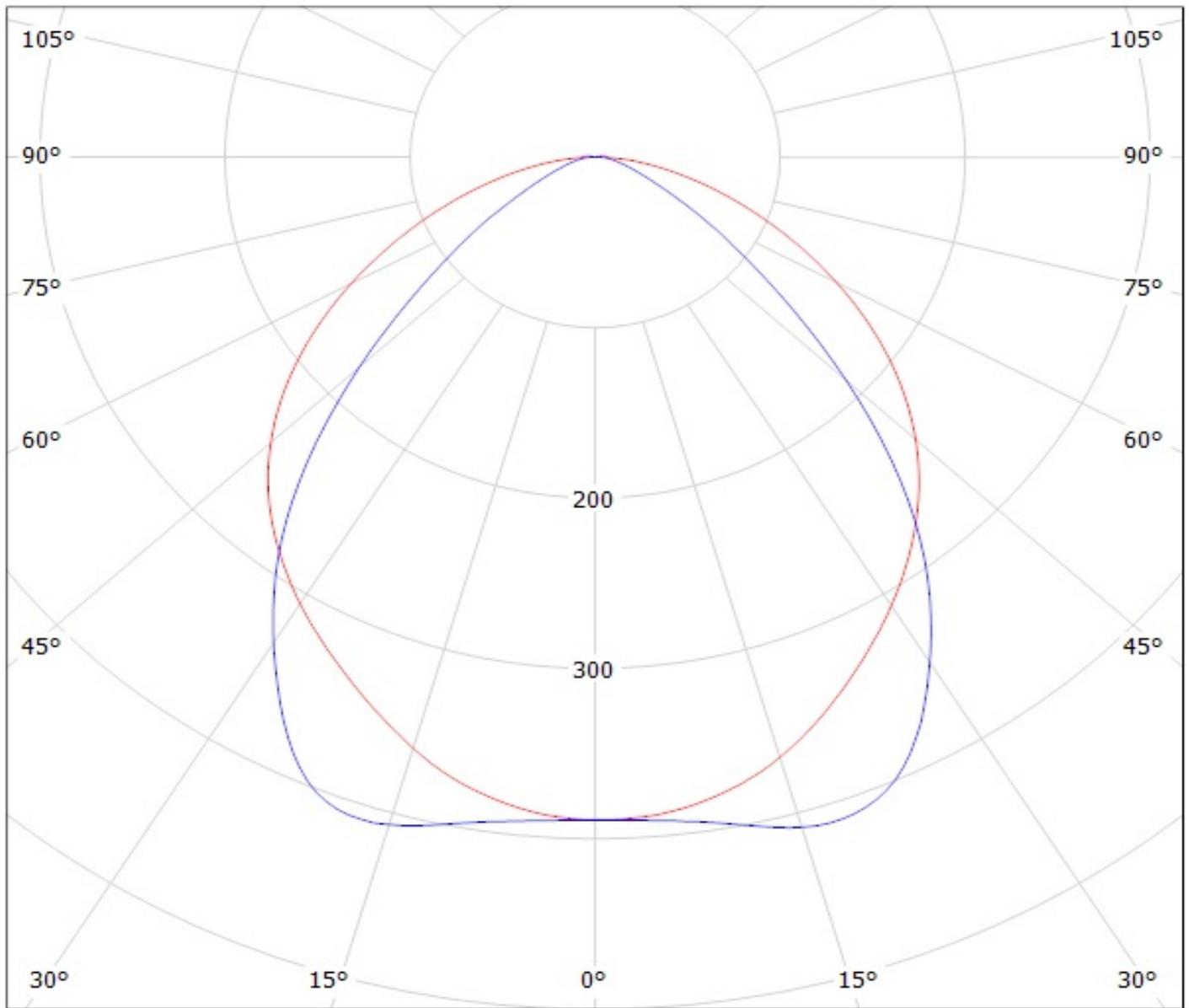

cd/klm

— C0 - C180

— C90 - C270

$\eta = 93\%$

Ledil F14304_FLORENCE-1R-Z90_(LM561B) / LDC (Polar)

Luminaire: Ledil F14304_FLORENCE-1R-Z90_(LM561B)

Lamps: 1 x Samsung_LM561B_x22_348.84lm@65mA_P=1.97W_I=65mA

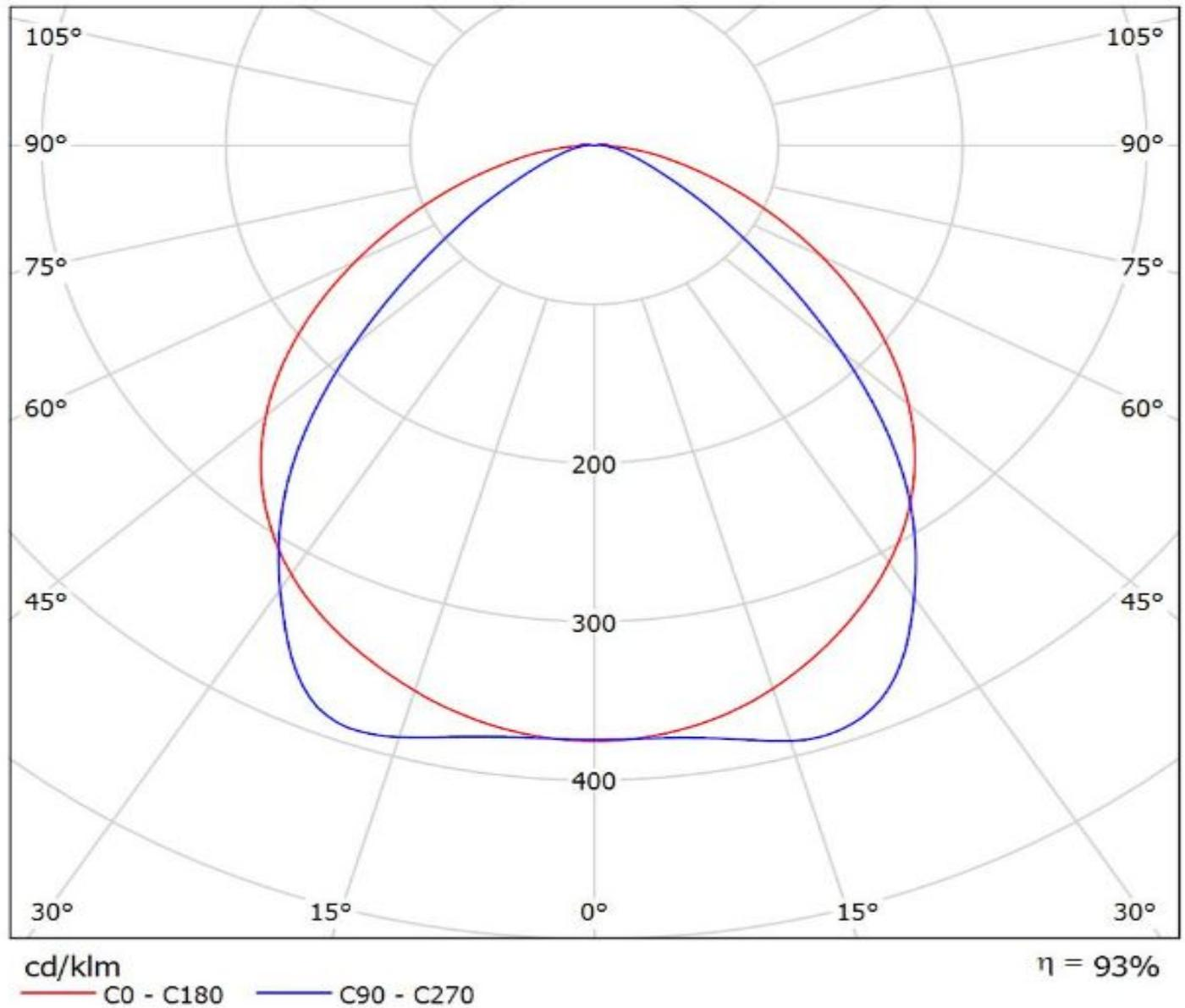

Luminaire: Ledil F14304_FLORENCE-1R-Z90_(LM301A)

Lamps: 1 x Samsung_LM301A_x11_(SPMWHT328FD5WAT0S0)_1087.4lm@250mA_P=8.1922W_I=0.25A

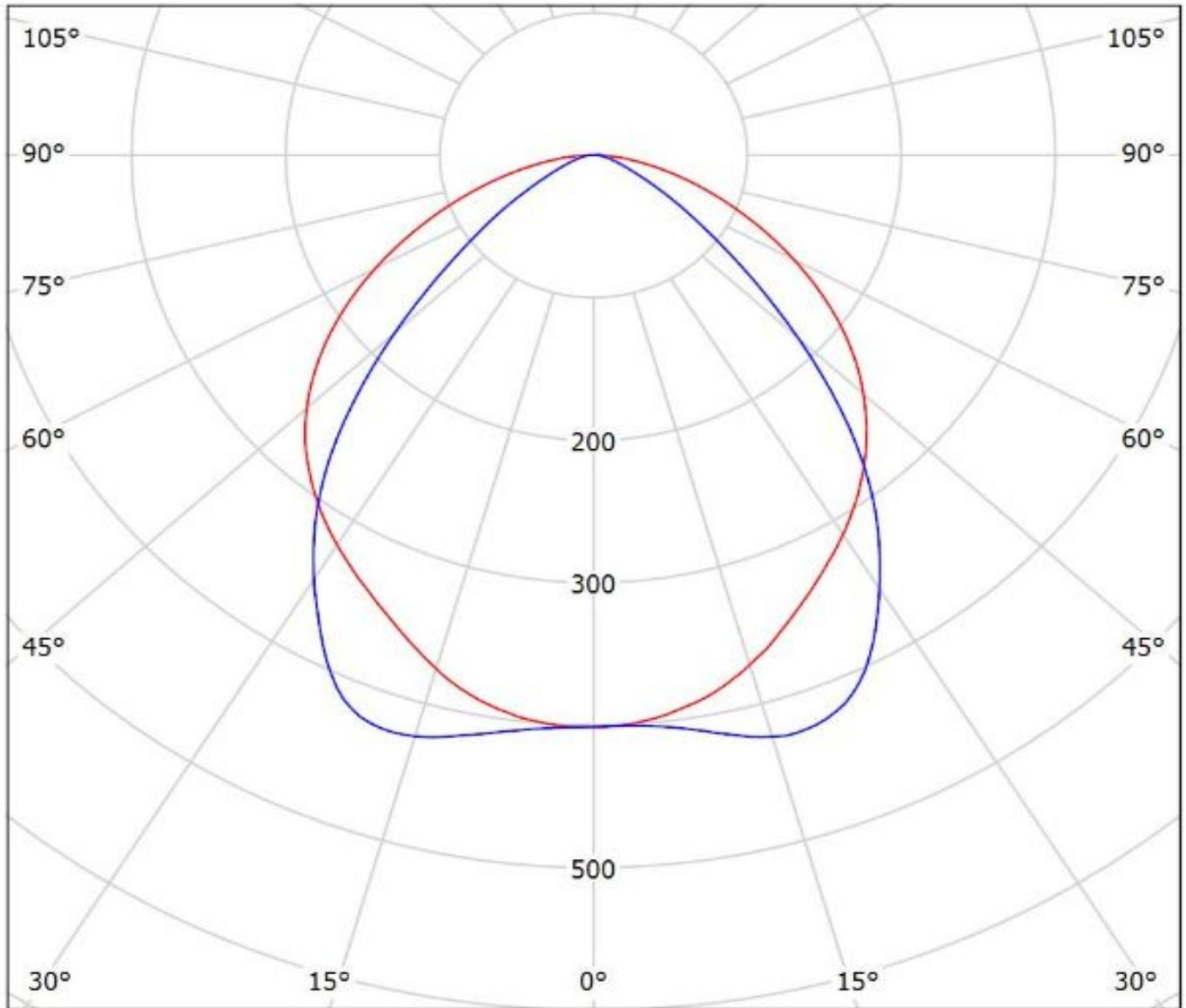

cd/klm

— C0 - C180 — C90 - C270

$\eta = 94\%$

Luminaire: Ledil F14304_FLORENCE-1R-Z90_(LT-S282N)

Lamps: 1 x Samsung SI-B8T071280LD_LM5618+_1401.55lm@250mA_P=9.185W_I=0.25A

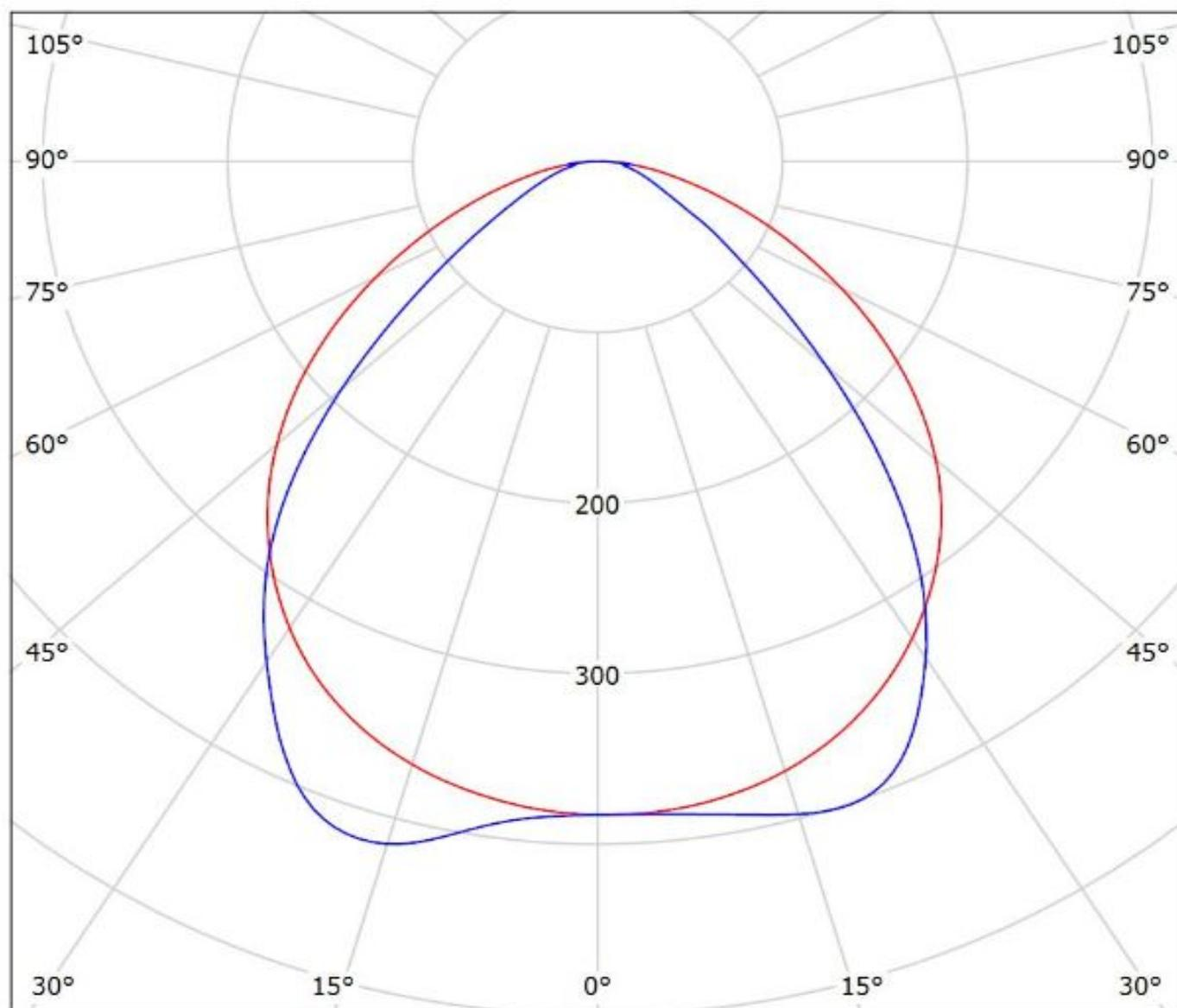

cd/klm

— C0 - C180 — C90 - C270

$\eta = 94\%$

Luminaire: LEDiL Oy F14304_FLORENCE-1R-Z90_(LM561C)

Lamps: 1 x Samsung_LM561C_688.201lm@130mA_P=3.9390W_I=0.130A

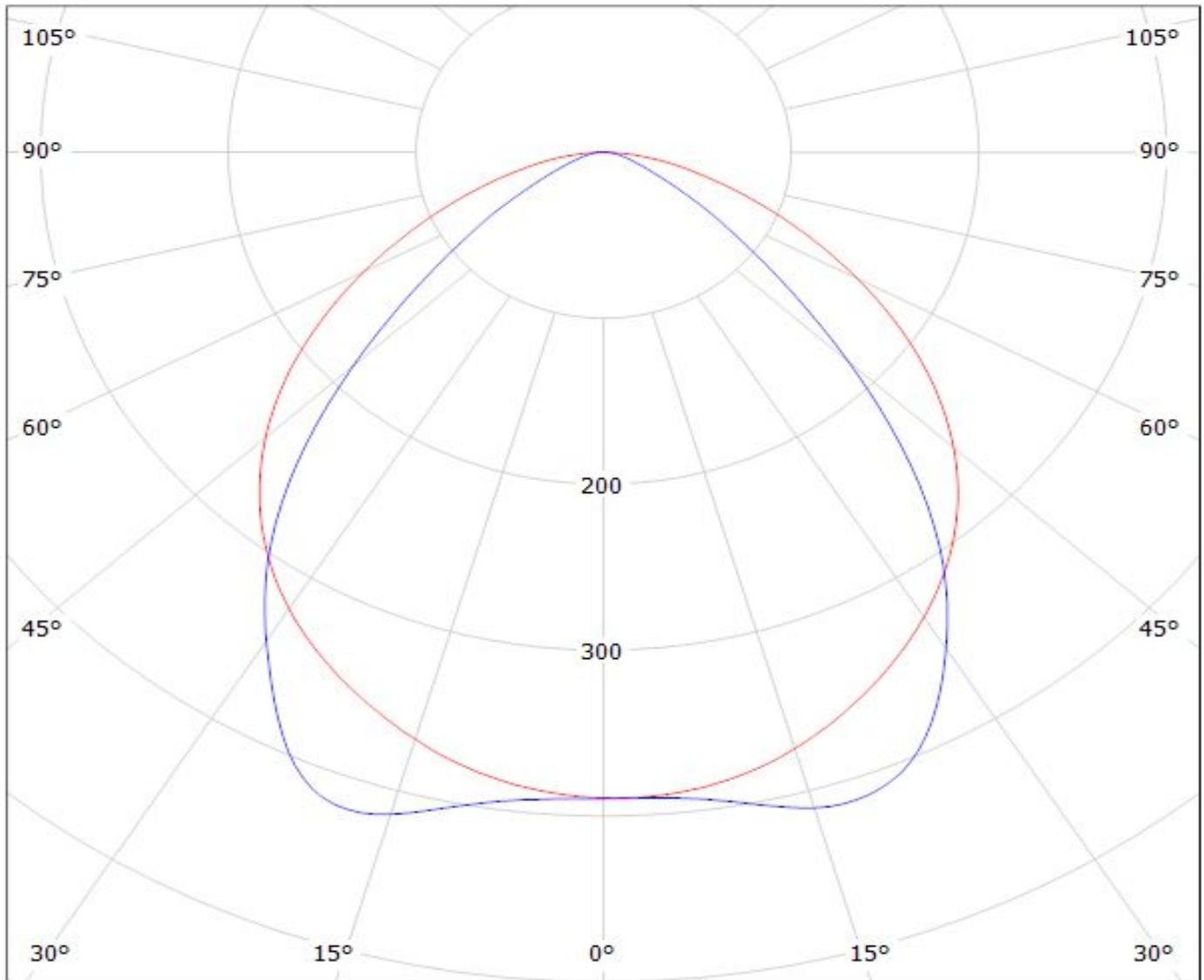

cd/klm

— C0 - C180

— C90 - C270

$\eta = 94\%$

Luminaire: LEDiL Oy F14304_FLORENCE-1R-Z90_(LM281B)

Lamps: 1 x Samsung_LM281B_1309.14lm@300mA_P=10.244W_η=0.300A

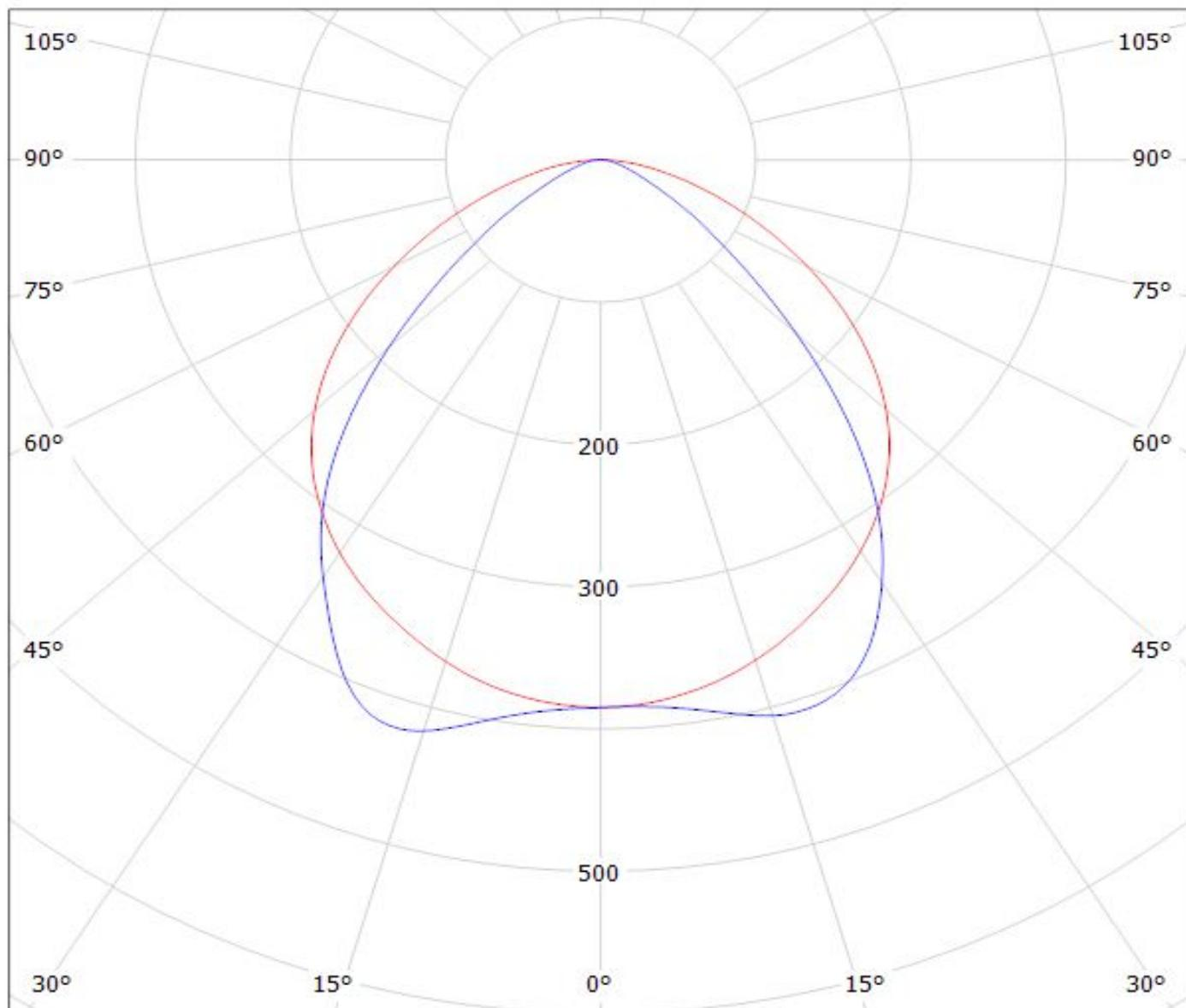

cd/klm

— C0 - C180

— C90 - C270

$\eta = 94\%$

Ledil F14304_FLORENCE-1R-Z90_(Seoul_3030) / LDC (Polar)

Luminaire: Ledil F14304_FLORENCE-1R-Z90_(Seoul_3030)

Lamps: 1 x Seoul_3030_x11_(STW8C2SA)_785.296lm@100mA_P=6.5W_I=0.1A

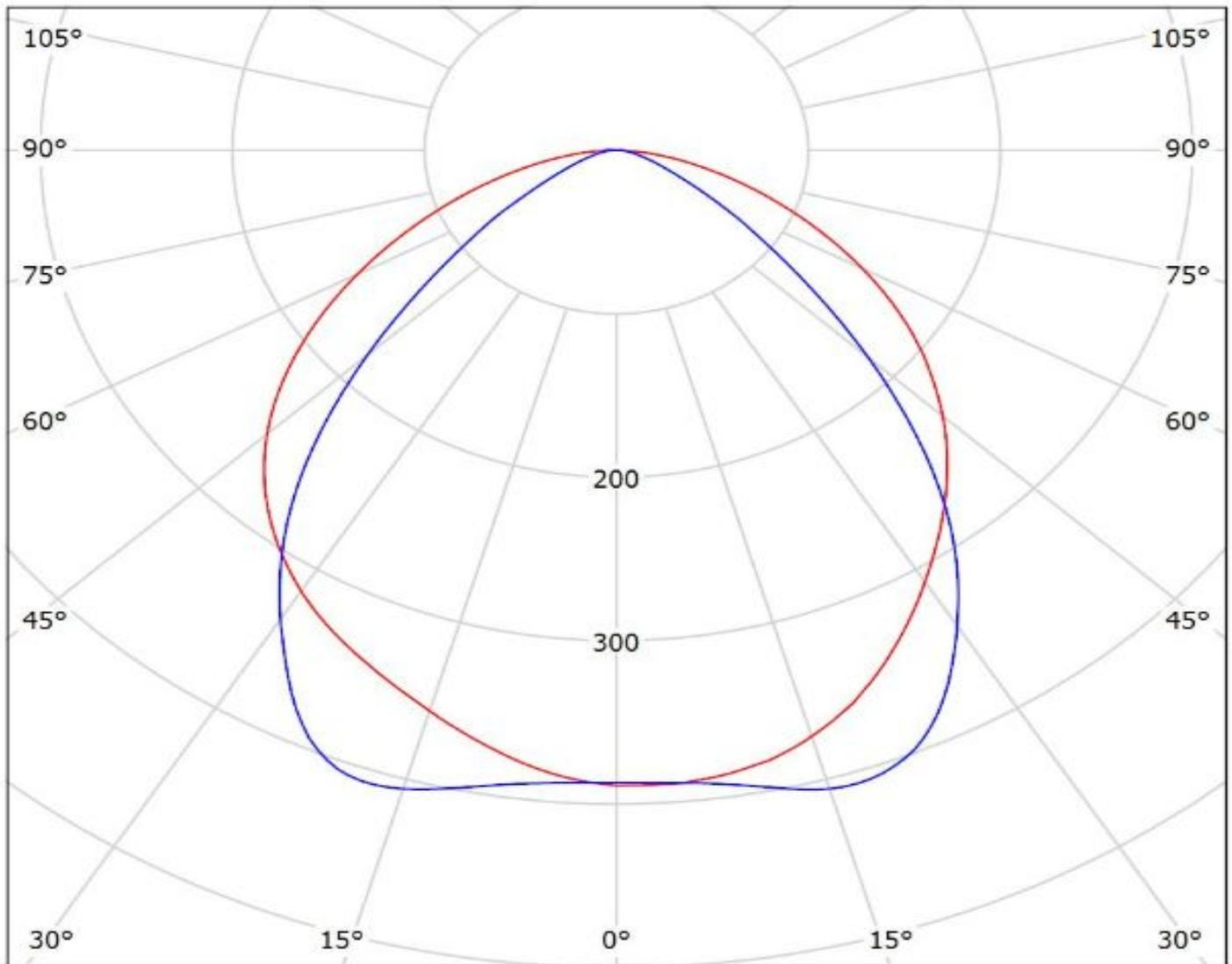

Luminaire: Ledil F14304_FLORENCE-1R-Z90_(CALGD0414-M8W1)

Lamps: 1 x Citizen_CALGD0414-M8W1_556.672lm@350mA_P=4.0291W_I=0.3499A

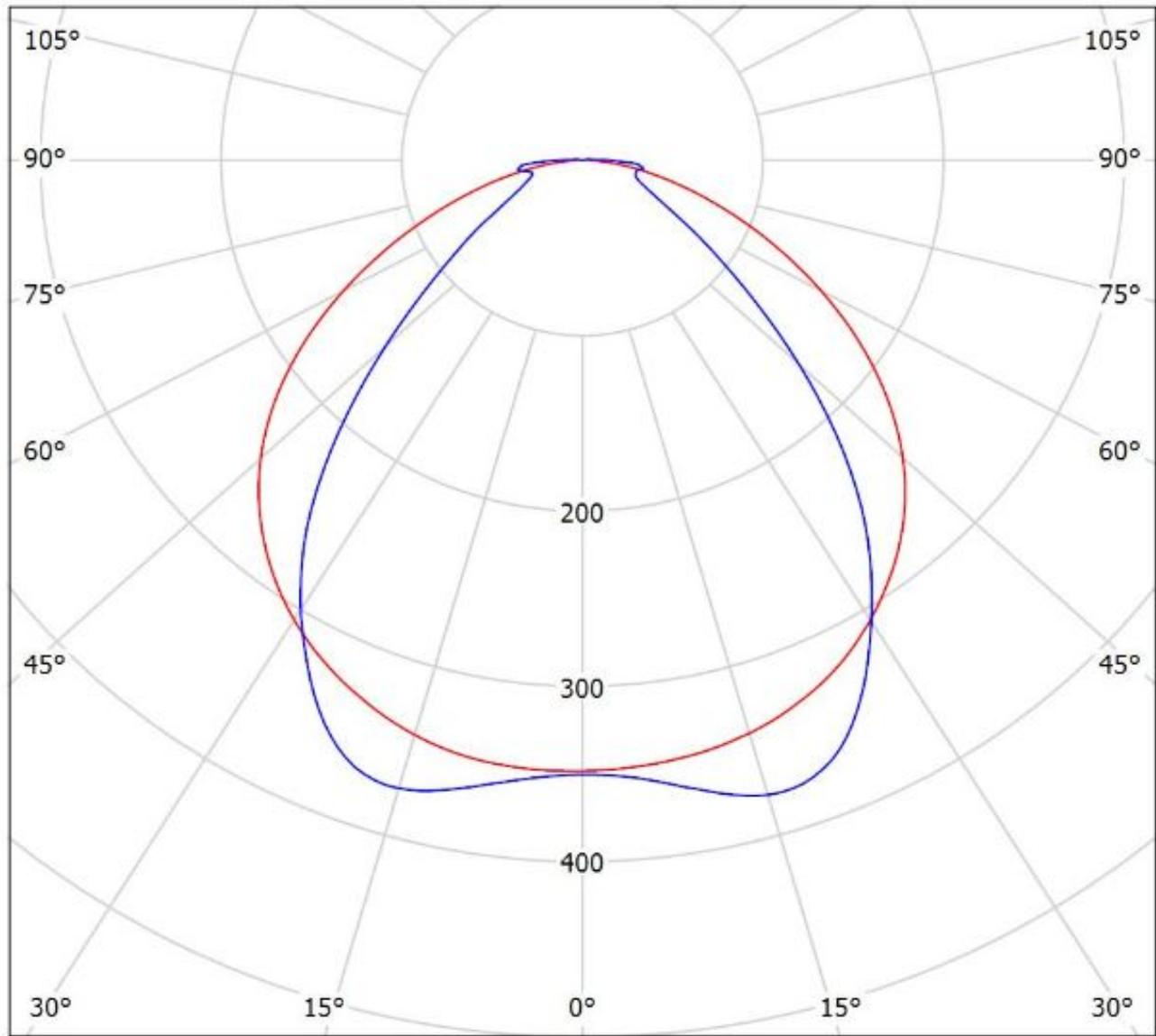

cd/klm

— C0 - C180 — C90 - C270

$\eta = 93\%$

Luminaire: Ledil F14304_FLORENCE-1R-Z90_(CALGD0814-M17W1)

Lamps: 1 x Citizen_(CALGD0814-M17W1)_1098.26lm@350mA_P=7.96302W_η=0.3499A

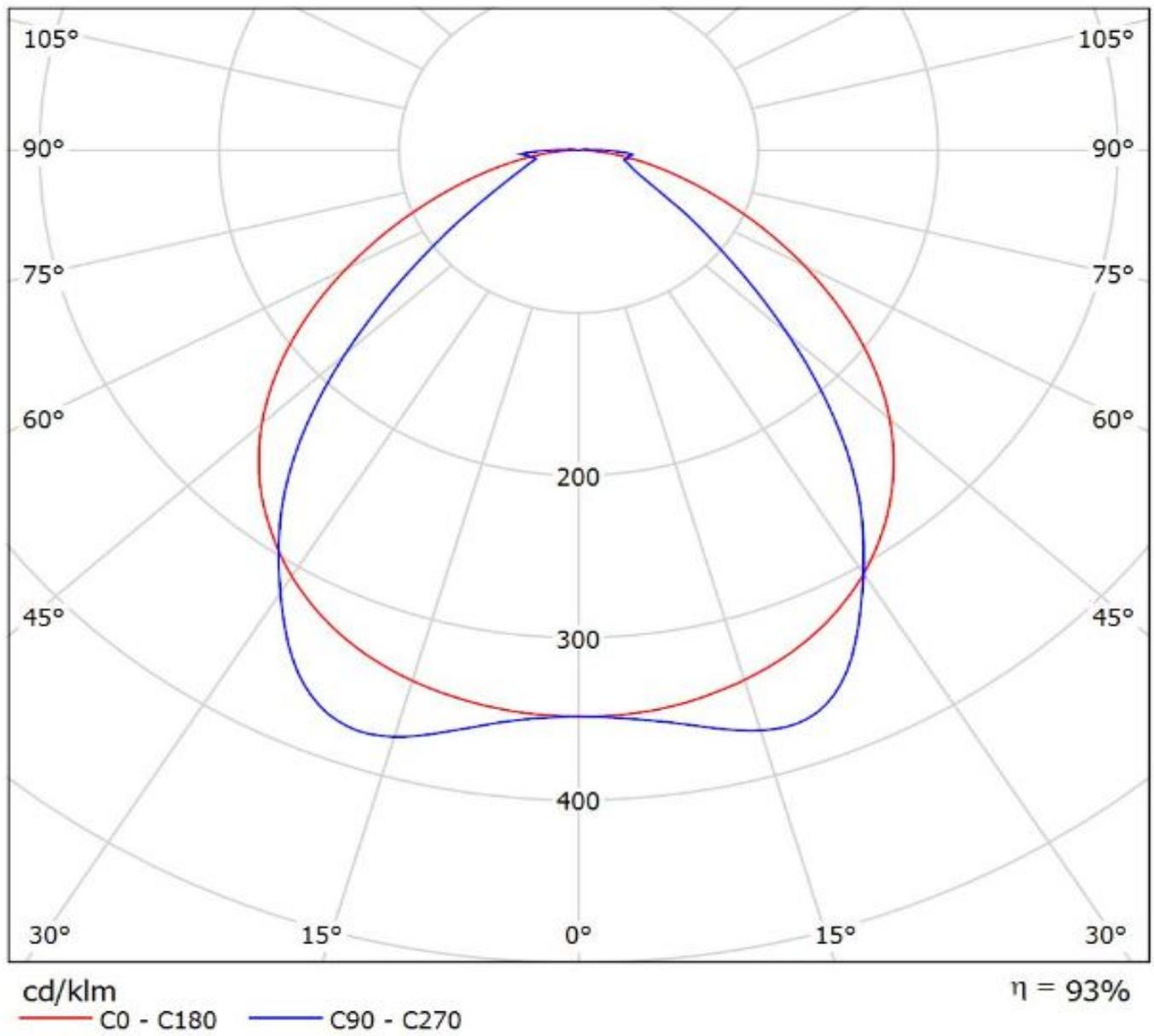

NOTE: The typical divergence will be changed by different color, chip size and chip position tolerance. The typical total divergence is the full angle measured where the luminous intensity is half of the peak value.