

# High IP3 Frequency Mixer

## MCA-19FH+

Level 17 (LO Power+17 dBm) 1850 to 1910 MHz



CASE STYLE: DZ883

### Maximum Ratings

Operating Temperature	-55°C to 100°C
Storage Temperature	-55°C to 100°C
LO & RF Power	20 dBm
Permanent damage may occur if any of these limits are exceeded.	

### Pin Connections

LO	10
RF	5
IF	3
GROUND	1,2,4,6,7,8,9

### Features

- excellent IP3, 35 dBm typ.
- excellent L-R isolation, 40 dB typ.
- excellent 1 dB compression, RF>LO power
- industry standard foot print
- LTCC design for excellent temperature stability, performance repeatability and small size
- aqueous washable
- double balanced mixer
- low price
- protected by US Patent 6,959,180

### Applications

- GSM 1800
- DECT

#### +RoHS Compliant

The +Suffix identifies RoHS Compliance. See our web site for RoHS Compliance methodologies and qualifications

Available Tape and Reel at no extra cost	
Reel Size	Devices/Reel
7"	10, 20, 50, 100, 200
13"	500,1000

### Outline Drawing

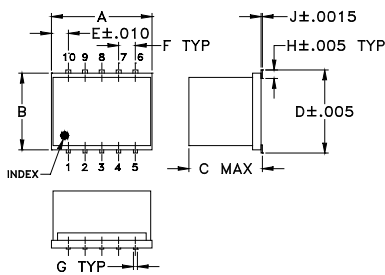

#### PCB Land Pattern

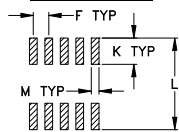

Suggested L layout, Tolerance to be within ±.002

### Outline Dimensions (inch/mm)

A	B	C	D	E	F	G
.30	.250	.190	.266	.050	.050	.012
7.62	6.35	4.83	6.76	1.27	1.27	0.30
H	J	K	L	M	wt	
.029	.004	.085	.296	.030	grams	
0.74	0.10	2.16	7.52	0.76	0.5	

### Demo Board MCL P/N: TB-144 Suggested PCB Layout (PL-045)

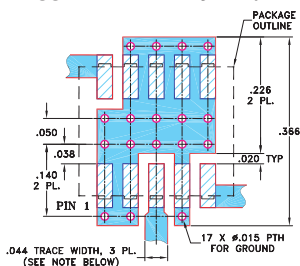

NOTES: 1. TRACE WIDTH IS SHOWN FOR ROGERS RO4350B WITH DIELECTRIC THICKNESS .020" ± .0015"; COPPER: 1/2 OZ. EACH SIDE. FOR OTHER MATERIALS TRACE WIDTH MAY NEED TO BE MODIFIED.  
2. BOTTOM SIDE OF THE PCB IS CONTINUOUS GROUND PLANE.

- DENOTES PCB COPPER LAYOUT WITH SMOBC (SOLDER MASK OVER BARE COPPER)
- DENOTES COPPER LAND PATTERN FREE OF SOLDER MASK

#### Notes

A. Performance and quality attributes and conditions not expressly stated in this specification document are intended to be excluded and do not form a part of this specification document.  
B. Electrical specifications and performance data contained in this specification document are based on Mini-Circuit's applicable established test performance criteria and measurement instructions.  
C. The parts covered by this specification document are subject to Mini-Circuit's standard limited warranty and terms and conditions (collectively, "Standard Terms"); Purchasers of this part are entitled to the rights and benefits contained therein. For a full statement of the Standard Terms and the exclusive rights and remedies thereunder, please visit Mini-Circuit's website at [www.minicircuits.com/MCLStore/terms.jsp](http://www.minicircuits.com/MCLStore/terms.jsp)

### Electrical Specifications (T<sub>AMB</sub>=-55°C to 100°C)

FREQUENCY (MHz)			IP3 (dBm)	RF in at 1 dB compr. (dBm)	CONVERSION LOSS (dB)		LO-RF ISOLATION (dB)		LO-IF ISOLATION (dB)	
RF	LO	IF			Typ.	Max.	Typ.	Min.	Typ.	Min.
1850-1910	1760-1820	70-130	35	17	6.9	8.5	40	22	39	20

### Typical Performance Data

Frequency (MHz)		Conversion Loss (dB)	Isolation L-R (dB)	Isolation L-I (dB)	VSWR RF Port (:1)	VSWR LO Port (:1)	IP3 (dBm)
RF	LO	LO +17dBm	LO +17dBm	LO +17dBm	LO +17dBm	LO +17dBm	LO +17dBm
1850.00	1760.00	6.97	42.92	49.99	1.97	2.39	37.53
1865.00	1775.00	6.97	41.92	45.39	2.00	2.08	36.85
1880.00	1790.00	6.93	40.95	41.21	1.97	1.96	36.93
1895.00	1805.00	6.88	40.70	38.54	1.92	2.01	36.79
1910.00	1820.00	6.82	40.68	36.69	1.90	2.25	37.12

### Electrical Schematic

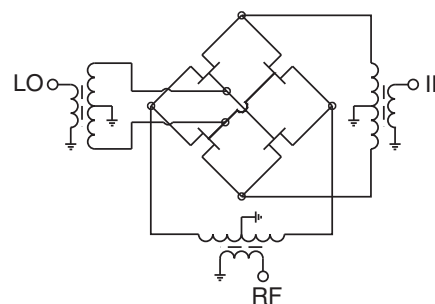

[www.minicircuits.com](http://www.minicircuits.com) P.O. Box 350166, Brooklyn, NY 11235-0003 (718) 934-4500 sales@minicircuits.com

REV. E  
M151107  
ED-9488A/2  
MCA-19FH+  
DJ/TD/CP  
160526

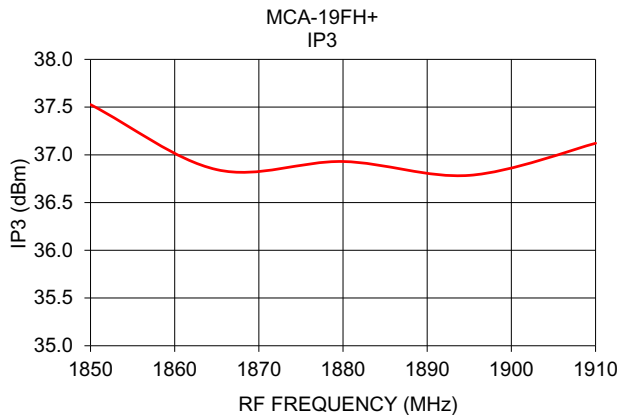
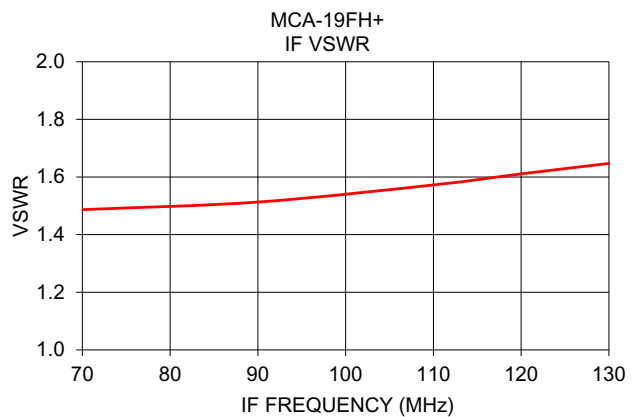
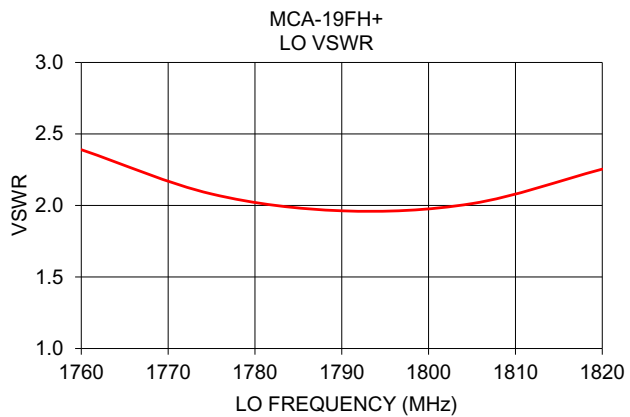
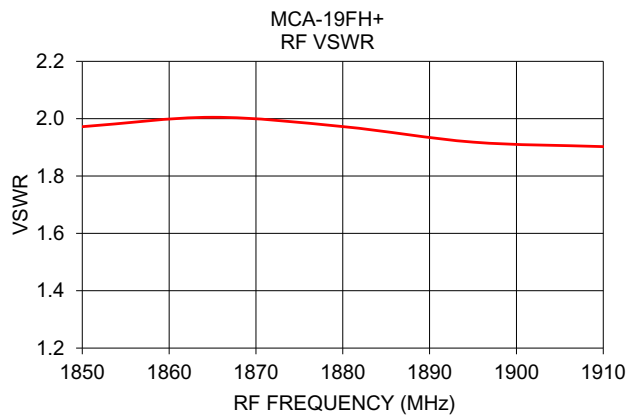
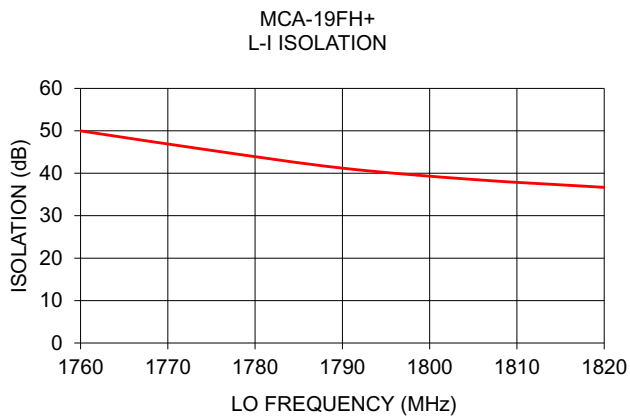
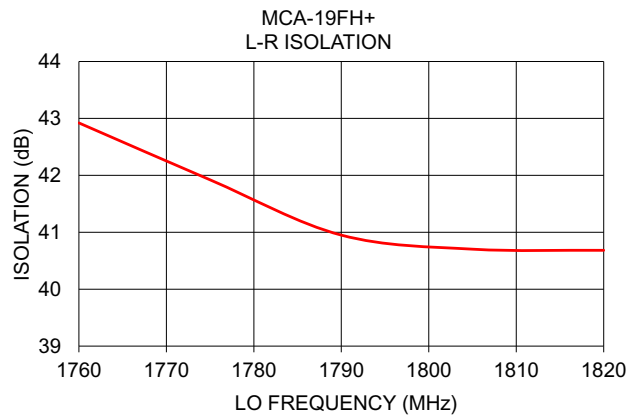
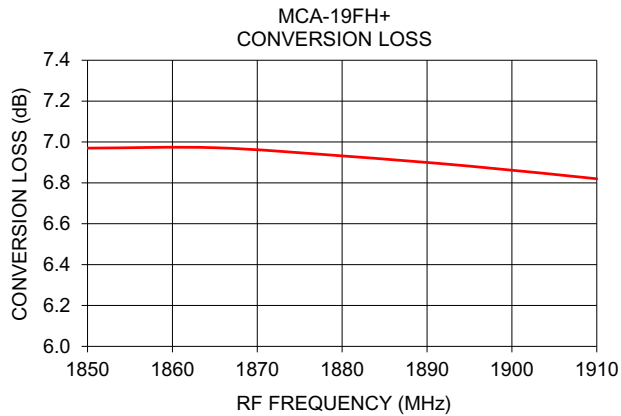

**Notes**

- A. Performance and quality attributes and conditions not expressly stated in this specification document are intended to be excluded and do not form a part of this specification document.
- B. Electrical specifications and performance data contained in this specification document are based on Mini-Circuit's applicable established test performance criteria and measurement instructions.
- C. The parts covered by this specification document are subject to Mini-Circuits standard limited warranty and terms and conditions (collectively, "Standard Terms"); Purchasers of this part are entitled to the rights and benefits contained therein. For a full statement of the Standard Terms and the exclusive rights and remedies thereunder, please visit Mini-Circuits' website at [www.minicircuits.com/MCLStore/terms.jsp](http://www.minicircuits.com/MCLStore/terms.jsp)

