



The Future of Analog IC Technology®

EV4013-S-00A High-Brightness High-Current Accuracy WLED Controller

DESCRIPTION

The EV4013-S-00A is designed to demonstrate the capabilities of MPS' MP4013 for LED backlighting applications. The MP4013 is a current mode controller designed for driving the high brightness Light Emitting Diodes (LEDs) with wide input voltage 8V-26V. It can be used in Boost, Buck, Buck-boost and SEPIC topologies

With a 36-60V input PVIN and an 8-26V power supply for MP4013, The evaluation board can drive a single LED string with the LED current regulated to 240mA and VLED voltage up to 150V. The PWM dimming, DC input analog dimming and pulse analog dimming are all included. The Over-Voltage protection, short LED protection, short inductor/diode protection and over current protection are integrated. The fault pin goes to low when fault conditions are detected.

ELECTRICAL SPECIFICATION

Parameter	Symbol	Value	Units
Input Voltage	PVIN	36-60	V
IC Power Supply	VIN	8-26	V
LED Voltage	V _{LED}	60 to 150	V
LED Current	I _{LED}	240	mA
Switching Frequency	fs	110	kHz
Over Voltage Protection	V _{OVP}	165	V

FEATURES

- Constant-current WLED Driver
- 600mV Feedback Voltage with ±1.2% Accuracy
- 8V-26V Input Voltage
- Programmable Switching Frequency
- Leading Edge Blanking for Current Sense
- High Dimming Ratio Fast DPWM Dimming
- DC Input or Pulse Signal Input Analog Dimming
- 5V Reference Voltage with ±1% Accuracy
- External PWM Dimming MOS Driver
- Soft Start
- Programmable Bus Voltage UVLO
- Over Voltage Protection
- Short LED Protection
- Short Output Protection
- Over Current Protection
- Short Inductor/Diode Protection
- Fault Indicator
- Thermal Shutdown

APPLICATIONS

- TV Backlighting
- Large LCD Panels Backlighting

For MPS green status, please visit MPS website under Quality Assurance. "MPS" and "The Future of Analog IC Technology", are Registered Trademarks of Monolithic Power Systems, Inc.



Warning: Although this board is designed to satisfy safety requirements, the engineering prototype has not been agency approved. Therefore, all testing should be performed using an isolation transformer to provide the AC input to the prototype board.

EV4013-S-00A EVALUATION BOARD

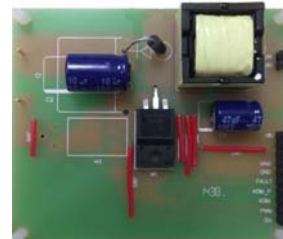

(L x W x H) 7.5cm x 6.5cm x 1.5cm

Board Number	MPS IC Number
EV4013-S-00A	MP4013GS

EVALUATION BOARD SCHEMATIC

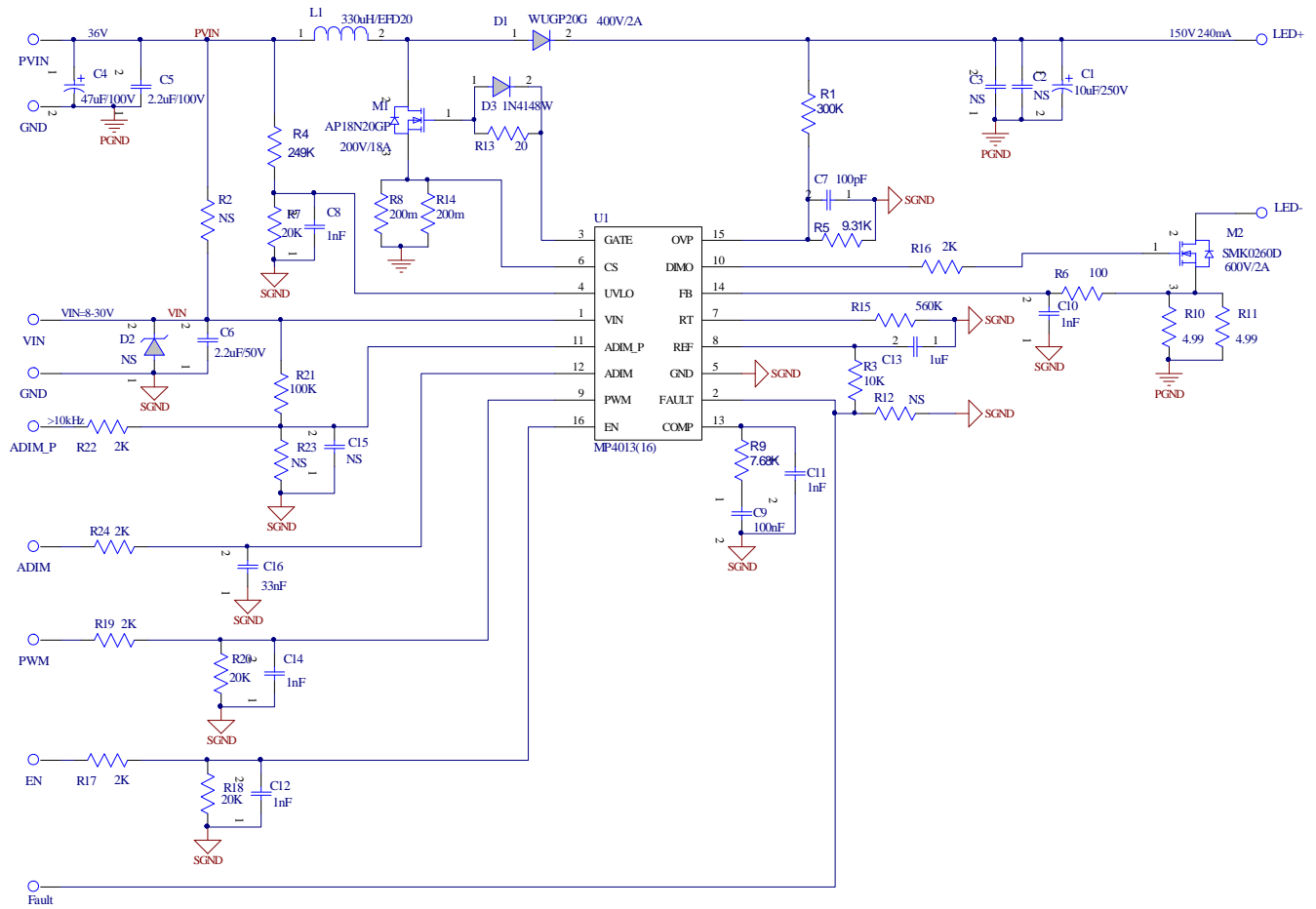

BILL OF MATERIALS

Qty	Designator	Value	Description	Package	Manufacture	Manufacture_PN
1	C1	10uF/250V	Capacitor;250V;20%	DIP	Panasonic	ECA-2EM100
3	C2,C3,C15	NS				
1	C4	47uF/100V	Capacitor;100V;20%	DIP	Panasonic	ECA-2AM470
1	C5	2.2uF/100V	Ceramic Capacitor;100V;X7R;1210;	1210	muRata	GRM32ER72A225KA35L
1	C6	2.2uF/50V	Ceramic Capacitor;50V;X7R;1206;	1206	muRata	GRM31CR71H225KA88L
1	C7	100pF	Ceramic Capacitor;50V;C0G;0603	0603	TDK	C1608COG1H101J
5	C8, C10, C11, C12, C14	1nF	Ceramic Capacitor;50V;X7R;0603;	0603	TDK	C1608X7R1H102K
1	C9	100nF	Ceramic Capacitor;50V;X7R;0603;	0603	muRata	GRM188R71H333KA61D
1	C13	1uF	Ceramic Capacitor;10V;X7R;0603	0603	LION	0603B105K100T
1	C16	33nF	Ceramic Capacitor;16V;X7R;0603;	0603	muRata	GRM188R71C333KAO1D
1	D1	WUGP20G	Diode;400V;2A	DO-204AC	ZOWIE	WUGP20G
1	D2	NS				
1	D3	1N4148W	Diode;75V;0.15A;	SOD-123	Diodes	1N4148W
1	L1	330uH/EFD20	EFD20,60 turns,	EFD20	Emei	FX371
1	M1	200V/18A	Mosfet;200V;170/10V;19;18	TO-220	APEC	AP18N20GP
1	M2	600V/2A	Mosfet;600V;3.9/10V;7;2	TO-252	Auk	SMK0260D
1	R1	300K	Film Resistor;1%;	1206	Yageo	RC1206FR-07300KL
3	R2,R12,R23	NS				
1	R3	10K	Film Resistor;1%;	0603	Yageo	RC0603FR-0710KL
1	R4	249K	Film Resistor;1%;	0603	Yageo	RC0603FR-07249KL
1	R5	9.31K	Film Resistor;1%;	0603	Yageo	RC0603FR-079K31L
1	R6	100	Film Resistor;1%;	0603	Yageo	RC0603FR-07100RL
3	R7, R18, R20	20K	Film Resistor;1%;1/10W;	0603	Yageo	RC0603FR-0720KL
2	R8, R14	200m	Film Resistor;1%	1206	Yageo	RL1206FR-070R2L
1	R9	7.68K	Film Resistor;1%	0603	Yageo	RC0603FR-077K68L
2	R10, R11	4.99	Film Resistor;1%	1206	Yageo	RC1206FR-074R99L
1	R13	20	Film Resistor;5%;1/10W	0603	LIZ	CR0603JA0200G
1	R15	560K	Film Resistor;1%;	0603	Yageo	RC0603FR-07560KL
5	R16, R17, R19, R22, R24	2K	Film Resistor;5%;1/10W	0603	LIZ	CR0603JA0202G
1	R21	100K	Film Resistor;1%;	0603	Yageo	RC0603FR-07100KL
1	JR1	0	Film Resistor;5%	1206	Yageo	RC1206JR-070RL
1	U1	MP4013	WLED Controller	SOIC-16	MPS	MP4013

EVB TEST RESULTS

$P_{VIN}=36V$, $V_{IN} = 24V$, $V_{LED}= 150V$, $I_{LED}=240mA$, $T_A = 25^{\circ}C$, unless otherwise noted.

DC-input Analog Dimming Curve

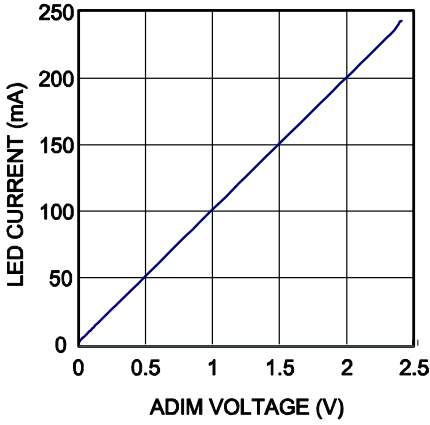

Pulse-Input Analog Dimming

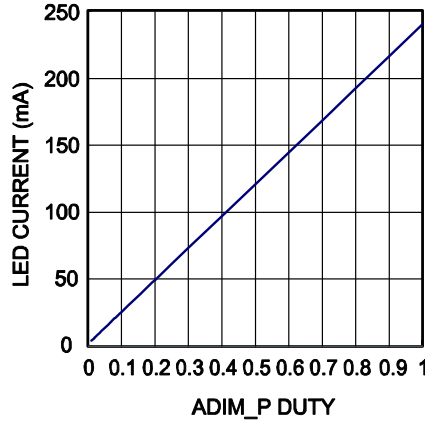

PWM Dimming Curve

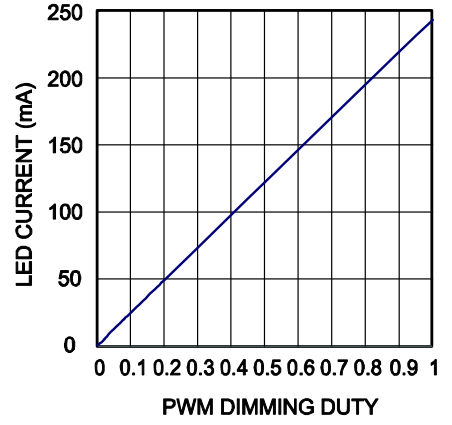

Efficiency vs. Input Voltage

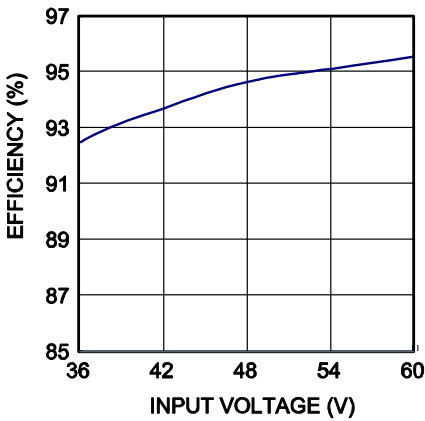

Efficiency vs. LED Voltage

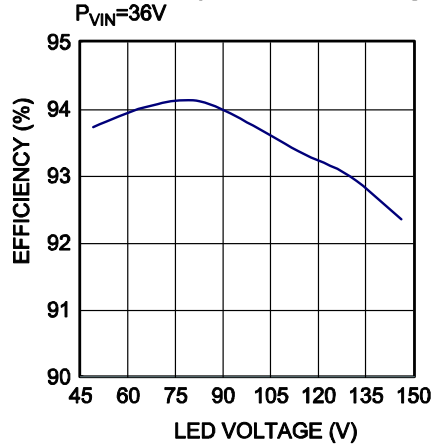

EVB TEST RESULTS *(continued)*

 PV_{IN}=36V, V_{IN} = 24V, V_{LED}= 150V, I_{LED}=240mA, T_A = 25°C, unless otherwise noted.

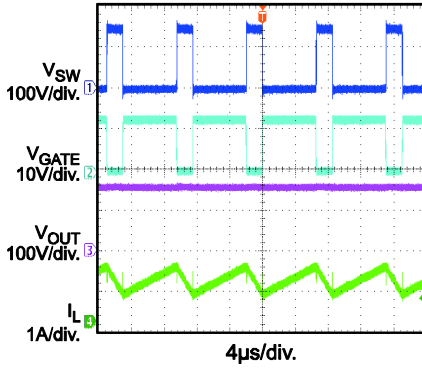
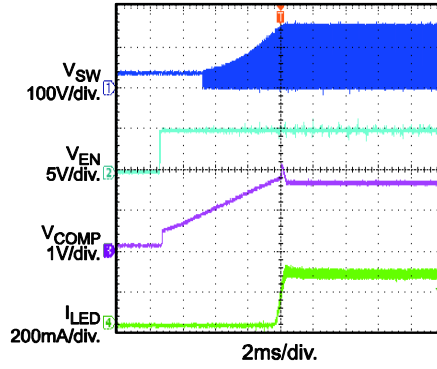
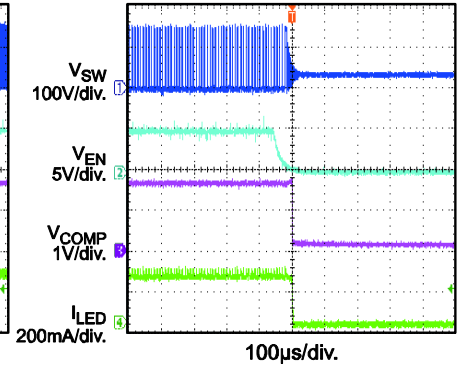
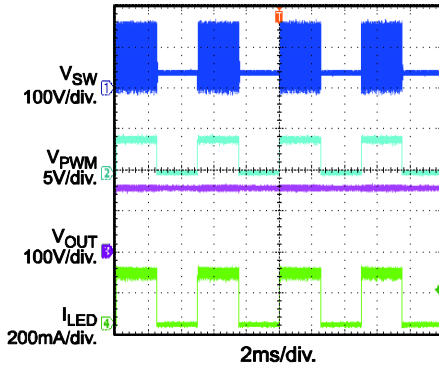
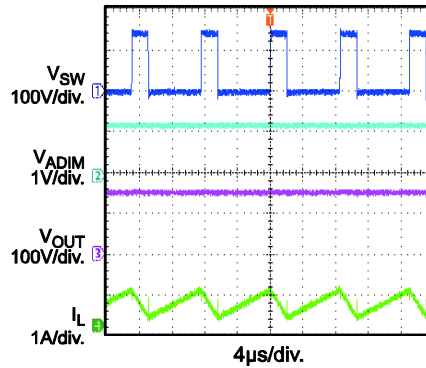
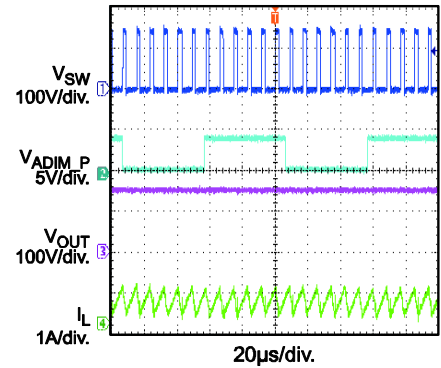
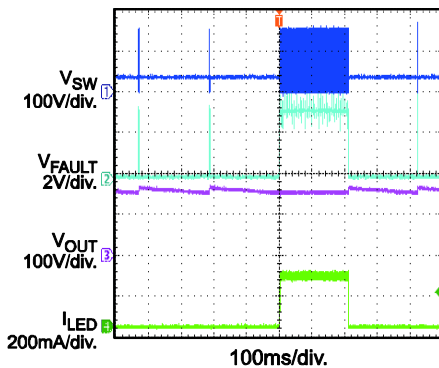
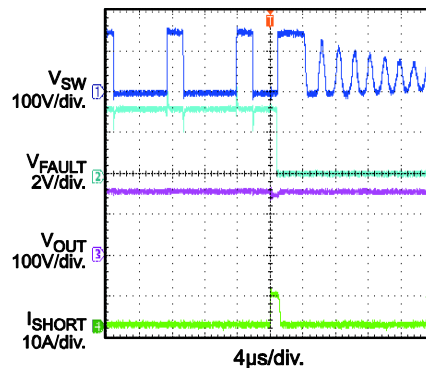
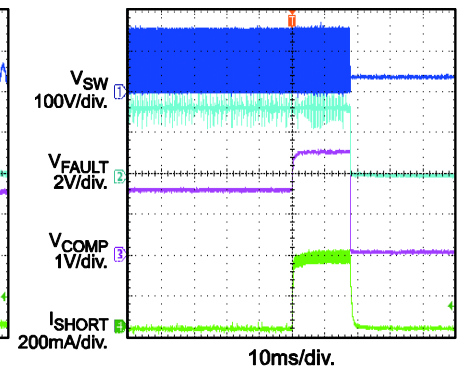
Steady State

EN On

EN Off

PWM Dimming
 f_{PWM}=200Hz

DC input Analog Dimming

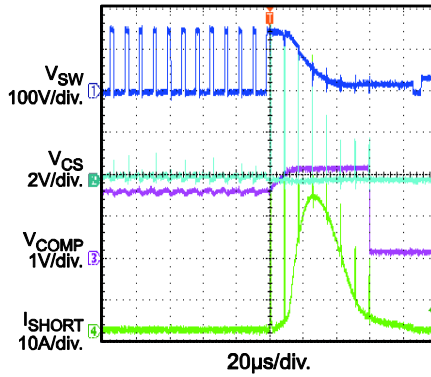
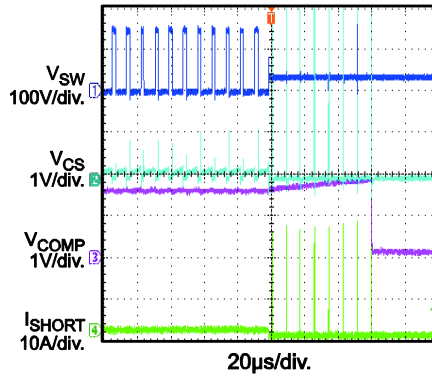
Pulse-input Analog Dimming

OVP

SLP

Short LED- to GND

EVB TEST RESULTS *(continued)*

$PV_{IN}=36V$, $V_{IN} = 24V$, $V_{LED}= 150V$, $I_{LED}=240mA$, $T_A = 25^{\circ}C$, unless otherwise noted.

Short Inductor

Short Diode



MAGNETIC COMPONENTS

A. FX371, Inductor (L1)

Electrical Diagram:

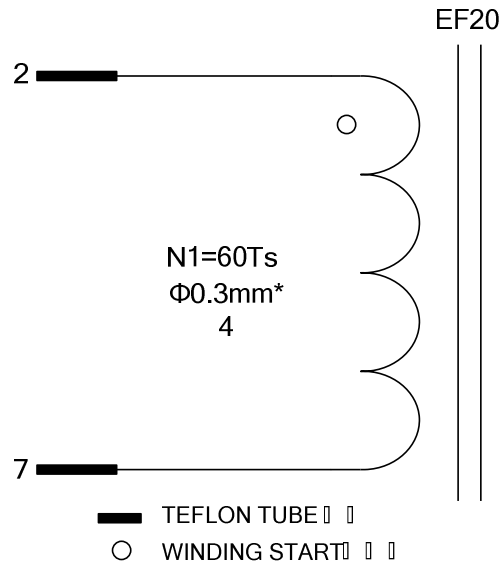

Winding Diagram

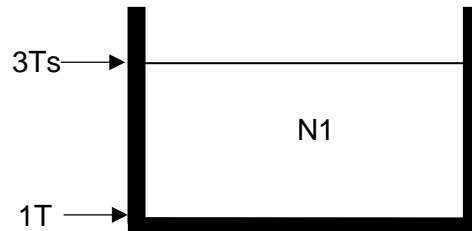

Winding Order

胶带圈数 (Tape Layer Number)	绕组顺序 (Winding No.)	始末脚位 (Start & End)	线径 φ (Magnet Wire)	圈数 (Turns)
1				
3	N1	2—7	0.3mm*4	60

Electric Characteristics

1	电感量 (Inductance)	L (2—7)	330μH±10%	100kHz
2	匝比 (Turn Ratio)	N1	60	
3	抗电强度 (Electrical Strength)	Pri. Side ~ Sec. Side		
		Pri. Side ~ Core		
		Sec. Side ~ Core		

PRINTED CIRCUIT BOARD LAYOUT

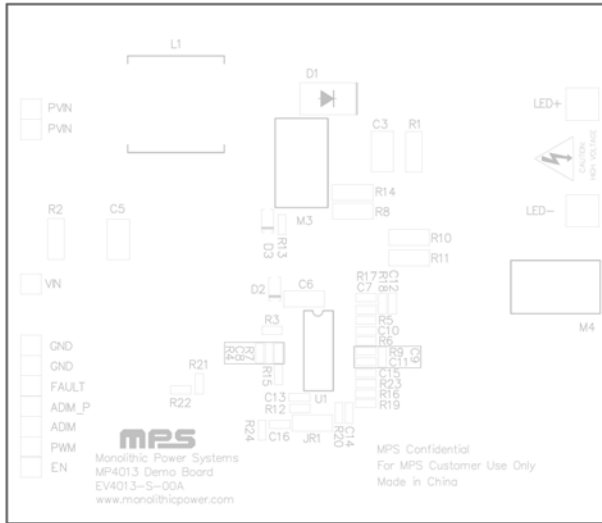

Figure 1—Top Silk Layer

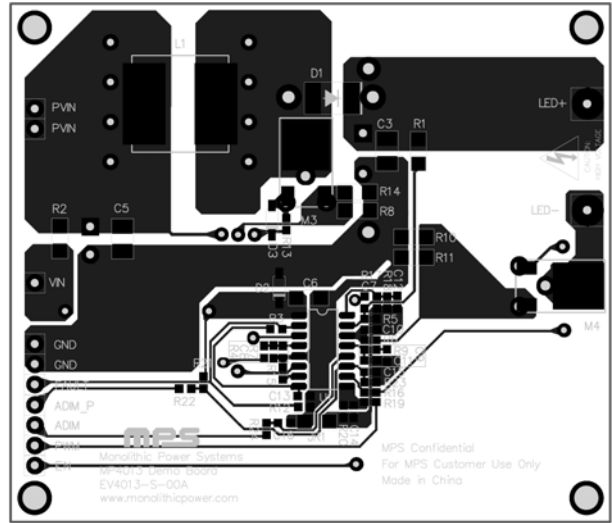

Figure 2—Top Layer

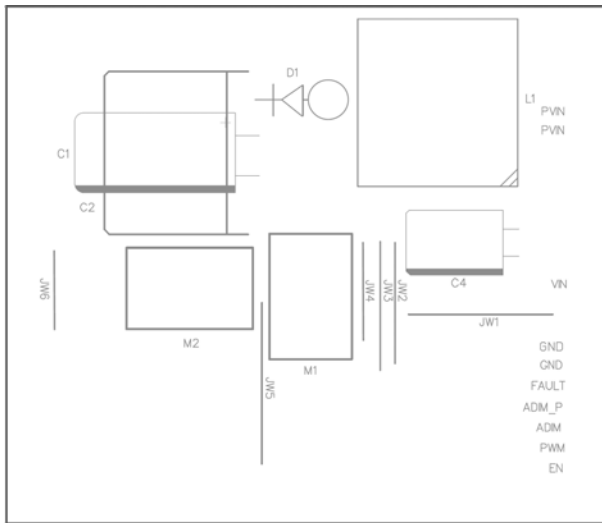

Figure 3—Bottom Silk Layer

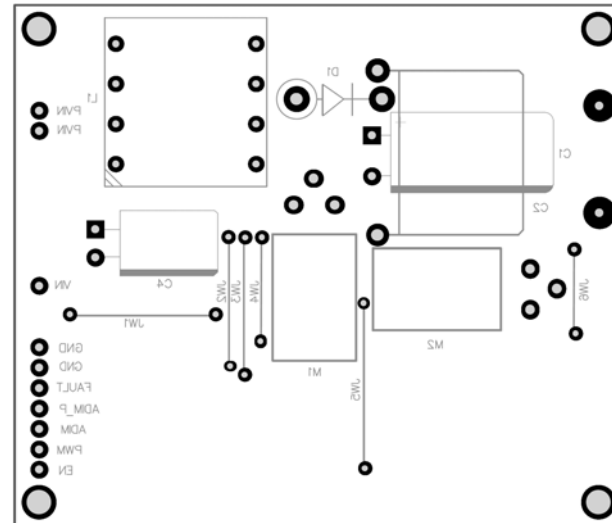

Figure 4—Bottom Layer

QUICK START GUIDE

1. Preset the LED string forward voltage to 60-150V, connect the anode of LED string to 'LED+' and the cathode of LED string to 'LED-';
2. Preset the PVIN supply voltage to 36-60V, turn off the power supply, connect the power supply to 'PVIN';
3. Preset the VIN supply voltage 8-26V, turn off the power supply, connect the power supply to 'VIN';
4. Connect the 'EN' connector to enable signal; the high level of EN signal is at the range of 1.5V-5V, the low level is at the range of 0-0.8V;
5. Connect the 'PWM' connector to the PWM dimming signal; the high level of PWM signal is in the range of 1.5V-5V, and the low level is in the range of 0-0.8V;
6. Connect the 'ADIM' connector to the DC input analog dimming signal; set the analog dimming signal 2.34V for full scale LED current;
7. Turn on PVIN supply, turn on VIN supply, set PWM signal and ADIM signal to high level; turn on EN signal, the LED string should be ignited.
8. To demo the PWM dimming function: connect the 'PWM' connector to an PWM signal; the frequency of the PWM signal is in the range of 100Hz to 2kHz, the high level of the PWM signal is 1.5V-5V and low level is 0-0.8V. Adjust the duty of the PWM signal; the LED current will follow the duty of the PWM dimming signal.
9. To demo the DC-input analog dimming, ramp down the voltage of ADIM signal from 2.34V to minimum (0V), the LED current amplitude will ramp down from full scale to minimum. The "ADIM_P" connector should be left open here.
10. To demo pulse-input analog dimming; leave the 'ADIM' connector open, connect 'ADIM_P' connector with a pulse signal, the frequency of the pulse signal higher than 10kHz, the high level higher than 1.5V and low level lower than 0.8V; Adjust the duty of the pulse signal from 100% to minimum, the LED current amplitude will decrease from full scale to minimum.

NOTICE: The information in this document is subject to change without notice. Please contact MPS for current specifications. Users should warrant and guarantee that third party Intellectual Property rights are not infringed upon when integrating MPS products into any application. MPS will not assume any legal responsibility for any said applications.