

# Hi-Reliability Optically Coupled Isolator

## JAN / JANTX / JANTXV 4N47, 4N48, 4N49 [A]



### Features:

- TO-78 hermetically sealed package
- High current transfer ratio
- 1 kV electrical isolation
- Base contact provided for conventional transistor biasing
- JAN, JANTX and JANTXV devices processed to MIL-PRF-19500
- Patent No. 4124860

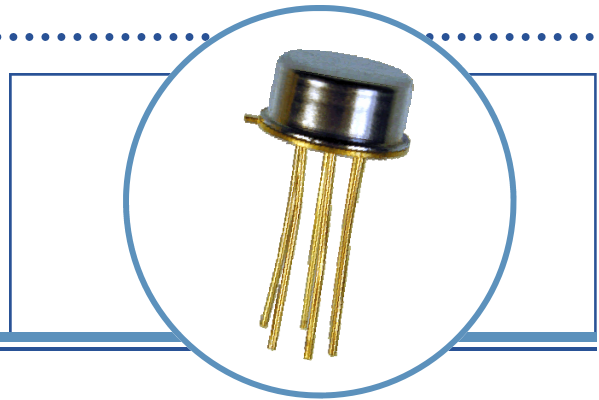

### Description:

Each isolator in this series consists of an infrared emitting diode and a NPN silicon phototransistor, which are mounted in a hermetically sealed TO-78 package. Devices are designed for military and/or harsh environments. The suffix letter "A" denotes the collector is electrically isolated from the case.

The JAN / JANTX / JANTXV 4N47, 4N47A, 4N48, 4N48A, 4N49, and 4N49A devices are processed to MIL-PRF-19500/548.

This series of 4N products are JEDEC registered, DSCC qualified.

Please contact your local representative or OPTEK for more information.

### Applications:

- High-voltage isolation between input and output
- Electrical isolation in dirty environments
- Industrial equipment
- Medical equipment
- Office

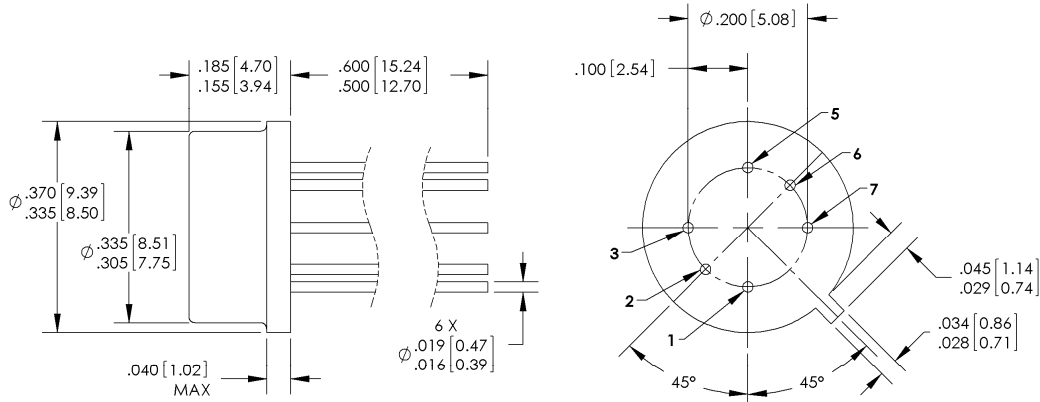

DIMENSIONS ARE IN INCHES [MM]

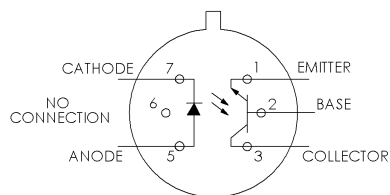

**BOTTOM VIEW**

Pin #	Function	Pin #	Function
3	Collector	5	Anode
2	Base	6	Open
1	Emitter	7	Cathode

This product is built, tested and shipped from the USA

OPTEK reserves the right to make changes at any time in order to improve design and to supply the best product possible.

# Hi-Reliability Optically Coupled Isolator

## JAN / JANTX / JANTXV 4N47, 4N48, 4N49 [A]



### Absolute Maximum Ratings ( $T_A = 25^\circ\text{C}$ unless otherwise noted)

Storage Temperature Range	-55° C to +150° C
Operating Temperature Range	-55° C to +125° C
Input-to-Output Isolation Voltage	$\pm 1.00\text{ kVDC}^{(1)}$
Lead Soldering Temperature [1/16 inch (1.6 mm) from case for 5 seconds with soldering iron]	260° C <sup>(2)</sup>

### Input Diode

Forward DC Current (65° C or below)	40 mA
Reverse Voltage	2 V
Power Dissipation	60 mW <sup>(3)</sup>

### Output Phototransistor:

Continuous Collector Current	50 mA
Collector-Emitter Voltage	40 V
Collector-Base Voltage	45 V
Emitter-Base Voltage	7.0 V
Power Dissipation	300 mW <sup>(4)</sup>

#### Notes:

1. Measured with input leads shorted together and output leads shorted together.
2. RMA flux is recommended. Duration can be extended to 10 seconds maximum when flow soldering.
3. Derate linearly 1.0 mW/° C above 65° C.
4. Derate linearly 3.0 mW/° C above 25° C.

Ordering Information				
Part Number	Isolation Voltage (kV)	$I_F$ (mA) Typ / Max	$V_{CE}$ (Volts) Max	Processing MIL-PRF-195000
JAN4N47 or JAN4N47A	1	1 / 40	40	548
JANTX4N47 or JANTX4N47A				
JANTXV4N47 or JANTXV4N47A				
JAN4N48 or JAN4N48A				
JANTX4N48 or JANTX4N48A				
JANTXV4N48 or JANTXV4N48A				
JAN4N49 or JAN4N49A				
JANTX4N49 or JANTX4N49A				
JANTXV4N49 or JANTXV4N49A				

This product is built, tested and shipped from the USA 

OPTEK reserves the right to make changes at any time in order to improve design and to supply the best product possible.

# Hi-Reliability Optically Coupled Isolator

## JAN / JANTX / JANTXV 4N47, 4N48, 4N49 [A]



### Electrical Characteristics ( $T_A = 25^\circ\text{C}$ unless otherwise noted)

SYMBOL	PARAMETER	MIN	TYP	MAX	UNITS	TEST CONDITIONS
--------	-----------	-----	-----	-----	-------	-----------------

#### Input Diode

$V_F$	Forward Voltage	0.80 1.00 0.70	- - -	1.50 1.70 1.30	V	$I_F = 10.0\text{ mA}$ $I_F = 10.0\text{ mA}, T_A = -55^\circ\text{C}^{(1)}$ $I_F = 10.0\text{ mA}, T_A = 100^\circ\text{C}^{(1)}$
$I_R$	Reverse Current	-	-	100	$\mu\text{A}$	$V_R = 2.0\text{ V}$

#### Output Phototransistor

$V_{(BR)CEO}$	Collector-Emitter Breakdown Voltage	40	-	-	V	$I_C = 1.0\text{ mA}, I_B = 0, I_F = 0$
$V_{(BR)CBO}$	Collector-Base Breakdown Voltage	45	-	-	V	$I_C = 100\ \mu\text{A}, I_B = 0, I_F = 0$
$V_{(BR)EBO}$	Emitter-Base Breakdown Voltage	7	-	-	V	$I_E = 100\ \mu\text{A}, I_C = 0, I_F = 0$
$I_{C(OFF)}^1$	Collector-Emitter Dark Current	-	-	100	nA	$V_{CE} = 20\text{ V}, I_B = 0, I_F = 0$
$I_{C(OFF)}^2$	Collector-Emitter Dark Current	-	-	100	$\mu\text{A}$	$V_{CE} = 20\text{ V}, I_B = 0, I_F = 0, T_A = 100^\circ\text{C}^{(1)}$
$I_{CB(OFF)}$	Collector-Base Dark Current	-	-	10	nA	$V_{CB} = 20\text{ V}, I_E = 0, I_F = 0$

#### Coupled

$I_{C(ON)}$	On-State Collector Current JAN / JANTX / JANTXV 4N47 [A]	0.50 0.70 0.50	- - -	- - -	mA	$I_F = 1.0\text{ mA}, V_{CE} = 5.0\text{ V}, I_B = 0$ $I_F = 2.0\text{ mA}, V_{CE} = 5.0\text{ V}, I_B = 0, T_A = -55^\circ\text{C}^{(1)}$ $I_F = 2.0\text{ mA}, V_{CE} = 5.0\text{ V}, I_B = 0, T_A = 100^\circ\text{C}^{(1)}$
	JAN / JANTX / JANTXV 4N48 [A]	1.00 1.40 1.00	- - -	5 - -		$I_F = 1.0\text{ mA}, V_{CE} = 5.0\text{ V}, I_B = 0$ $I_F = 2.0\text{ mA}, V_{CE} = 5.0\text{ V}, I_B = 0, T_A = -55^\circ\text{C}^{(1)}$ $I_F = 2.0\text{ mA}, V_{CE} = 5.0\text{ V}, I_B = 0, T_A = 100^\circ\text{C}^{(1)}$
	JAN / JANTX / JANTXV 4N49 [A]	2.00 2.80 2.00	- - -	10 - -		$I_F = 1.0\text{ mA}, V_{CE} = 5.0\text{ V}, I_B = 0$ $I_F = 2.0\text{ mA}, V_{CE} = 5.0\text{ V}, I_B = 0, T_A = -55^\circ\text{C}^{(1)}$ $I_F = 2.0\text{ mA}, V_{CE} = 5.0\text{ V}, I_B = 0, T_A = 100^\circ\text{C}^{(1)}$
$I_{CB(ON)}$	On-State Collector Base	30	-	-	$\mu\text{A}$	$V_{CB} = 5\text{ V}, I_E = 0, I_F = 10\text{ mA}$
$V_{CE(SAT)}$	Collector-Emitter Saturation Voltage JAN / JANTX / JANTXV 4N47 [A]	-	-	0.30	V	$I_F = 2.0\text{ mA}, I_C = 0.5\text{ mA}, I_B = 0$
	JAN / JANTX / JANTXV 4N48 [A]	-	-	0.30		$I_F = 2.0\text{ mA}, I_C = 1.0\text{ mA}, I_B = 0$
	JAN / JANTX / JANTXV 4N49 [A]	-	-	0.30		$I_F = 2.0\text{ mA}, I_C = 2.0\text{ mA}, I_B = 0$
$H_{FE}$	DC Current Gain	100	-	-	V	$V_{CE} = 5.0\text{ V}, I_C = 10.0\text{ mA}, I_F = 0\text{ mA}$
$R_{IO}$	Resistance (Input-to-Output)	$10^{11}$	-	-	$\Omega$	$V_{I-O} = \pm 1000\text{ VDC}^{(3)}$
$C_{IO}$	Capacitance (Input-to-Output)	-	-	5	pF	$V_{I-O} = 0\text{ V}, f = 1.0\text{ MHz}^{(3)}$
$T_R, T_F$	Rise and Fall Time	-	-	20	$\mu\text{s}$	$V_{CC} = 10.0\text{ V}, I_F = 5.0\text{ mA}, R_L = 100\ \Omega$

#### Notes:

1. Guaranteed but not tested.
2. Sample tested, LTPD = 10.
3. Measured with input leads shorted together and output leads shorted together.

This product is built, tested and shipped from the USA 

OPTEK reserves the right to make changes at any time in order to improve design and to supply the best product possible.

Typical Performance Curves

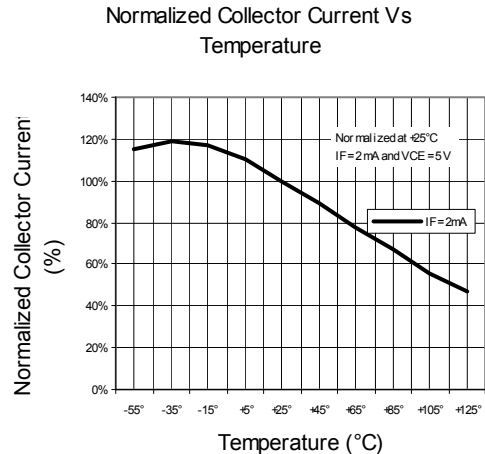
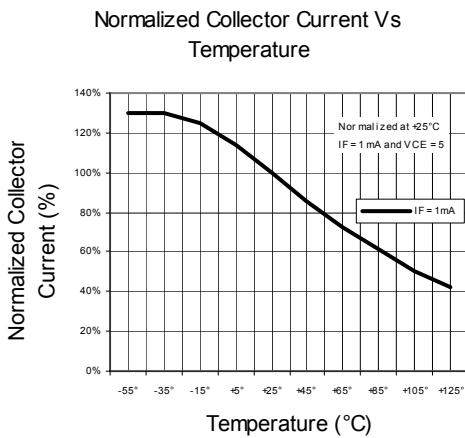
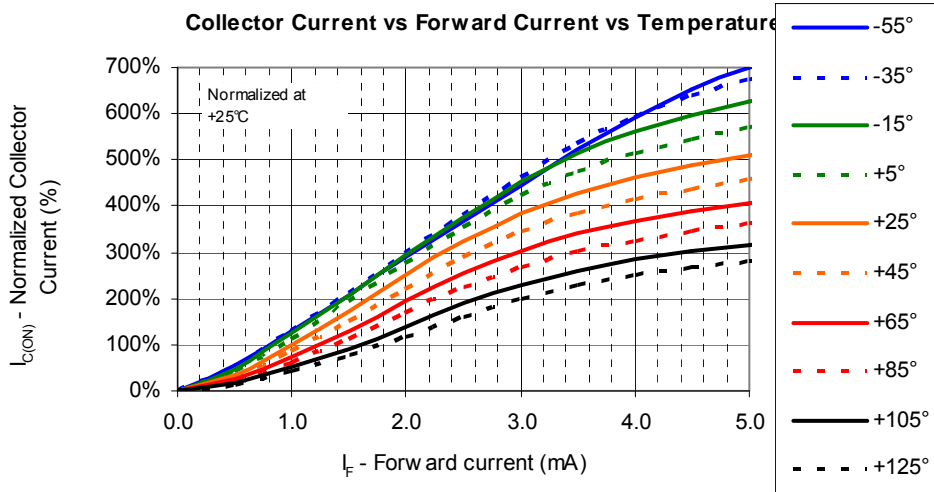
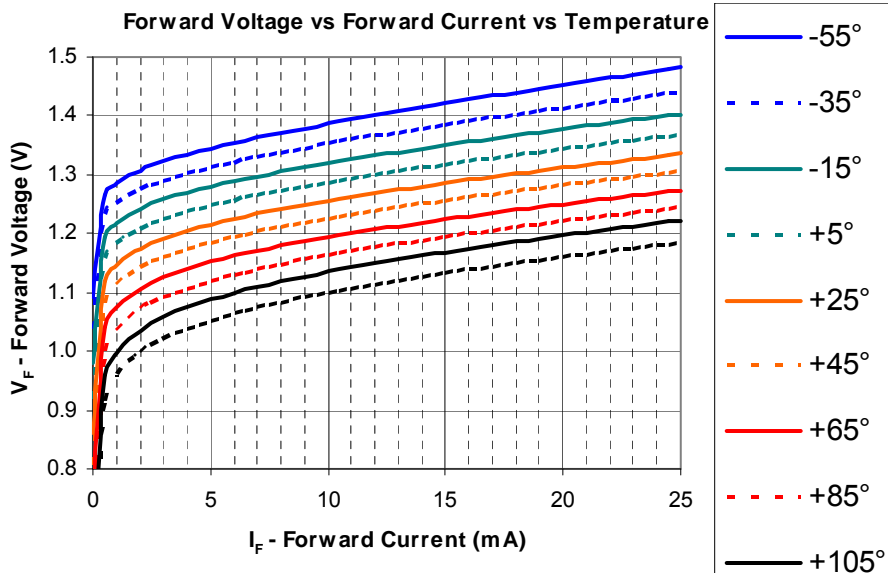

This product is built, tested and shipped from the USA 

OPTeK reserves the right to make changes at any time in order to improve design and to supply the best product possible.