

# Transient Voltage Suppressors

**SA Series**

## Transient Voltage Suppressors - SA Series

### Features

1. Halogen-free
2. Rohs compliant
3. Typical maximum temperature coefficient
4.  $\Delta V_{BR} = 0.1\% \times V_{BR} @ 25^{\circ}\text{C} \times \Delta T$
5. Glass passivated Chip junction in P600 package
6. 500W peak pulse capadility at 10x1000 $\mu\text{s}$  waveform, repetition rate (duty cycles):0.01%
7. Fast response time: typically less than 1.0ps from 0 Volts to BV min
8. Excellent clamping capability
9. Low incremental surge resistance
10. Typical IR less than 5 $\mu\text{A}$  above 12V
11. High temperature soldering guaranteed: 260 $^{\circ}\text{C}$ /40 seconds / 0.375", (9.5mm) lead length, 5lbs., (2.3kg)tension
12. Plastic package has underwriters laboratory flammability classification 94v-0

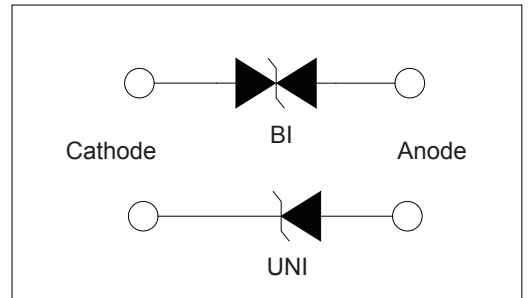
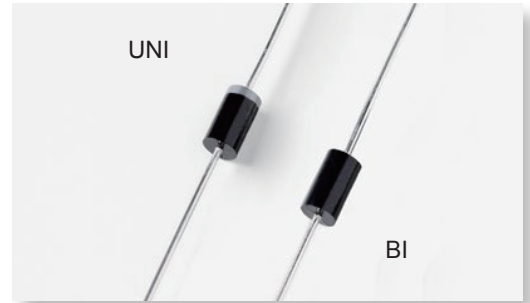

### Applications

TVS devices are ideal for the protection of I/O interfaces, VCC bus and other vulnerable circuits used in telecom, computer, industrial and consumer electronic applications.

### Mechanical Characteristics

Rating	Symbol	Value	Units
Peak Pulse Power Dissipation by 10x1000 $\mu\text{s}$ test waveform (Fig.1)(Note 1)	$P_{PPM}$	500	Watts
Steady State Power Dissipation on infinite heat sink at TL=75 $^{\circ}\text{C}$ (Fig. 5)	$P_D$	3	Watts
Peak Forward Surge Current, 8.3ms Single Half Sine Wave Unidirectional only (Note 2)	$I_{FSM}$	70	Amps
Maximum Instantaneous Forward Voltage at 25A for Unidirectional only (Note 3)	$V_F$	3.5/5.0	V
Operating junction and Storage Temperature Range.	$T_J, T_{STG}$	-55 $^{\circ}\text{C}$ to 175 $^{\circ}\text{C}$	$^{\circ}\text{C}$
Typical Thermal Resistance Junction to Lead	$R_{\theta JL}$	20	$^{\circ}\text{C}/\text{W}$
Typical Thermal Resistance Junction to Ambient	$R_{\theta JA}$	75	$^{\circ}\text{C}/\text{W}$

Notes:

1. Non-repetitive current pulse , per Fig. 3 and derated above  $T_A = 25^{\circ}\text{C}$  per Fig. 2.
2. Measured on 8.3ms single half sine wave or equivalent square wave, duty cycle=4 perminute maximum.

## Electrical Characteristics

Type Number		Reverse Stand-Off Voltage	Breakdown Voltage@IT		Test Current	Maximum Clamping Voltage@IPP	Peak Pulse Current	Reverse Leakage @VRWM
(UNI)	(BI)	VRWM(V)	VBR MIN.(V)	VBR.MAX.(V)	IT(mA)	VC(V)	IPP(A)	IR(μA)
SA5.0A	SA5.0CA	5.0	6.40	7.00	10	9.2	55.4	600
SA6.0A	SA6.0CA	6.0	6.67	7.37	10	10.3	49.5	600
SA6.5A	SA6.5CA	6.5	7.22	7.98	10	11.2	45.5	400
SA7.0A	SA7.0CA	7.0	7.78	8.60	10	12.0	42.5	150
SA7.5A	SA7.5CA	7.5	8.33	9.21	1	12.9	39.5	50
SA8.0A	SA8.0CA	8.0	8.89	9.83	1	13.6	37.5	25
SA8.5A	SA8.5CA	8.5	9.44	10.40	1	14.4	35.4	10
SA9.0A	SA9.0CA	9.0	10.00	11.10	1	15.4	33.1	5
SA10A	SA10CA	10.0	11.10	12.30	1	17.0	30.0	5
SA11A	SA11CA	11.0	12.20	13.50	1	18.2	28.0	5
SA12A	SA12CA	12.0	13.30	14.70	1	19.9	25.6	5
SA13A	SA13CA	13.0	14.40	15.90	1	21.5	23.7	5
SA14A	SA14CA	14.0	15.60	17.20	1	23.2	22.0	5
SA15A	SA15CA	15.0	16.70	18.50	1	24.4	20.0	5
SA16A	SA16CA	16.0	17.80	19.70	1	26.0	19.6	5
SA17A	SA17CA	17.0	18.90	20.90	1	27.6	18.5	5
SA18A	SA18CA	18.0	20.00	22.10	1	29.2	17.5	5
SA20A	SA20CA	20.0	22.20	24.50	1	32.4	15.7	5
SA22A	SA22CA	22.0	24.40	26.90	1	35.5	14.4	5
SA24A	SA24CA	24.0	26.70	29.50	1	38.9	13.1	5
SA26A	SA26CA	26.0	28.90	31.90	1	42.1	12.1	5
SA28A	SA28CA	28.0	31.10	34.40	1	45.4	11.2	5
SA30A	SA30CA	30.0	33.30	36.80	1	48.4	10.5	5
SA33A	SA33CA	33.0	36.70	40.60	1	53.3	9.6	5
SA36A	SA36CA	36.0	40.00	44.20	1	58.1	8.8	5
SA40A	SA40CA	40.0	44.40	49.10	1	64.5	7.9	5
SA43A	SA43CA	43.0	47.80	52.80	1	69.4	7.3	5
SA45A	SA45CA	45.0	50.00	55.30	1	72.7	7.0	5
SA48A	SA48CA	48.0	53.30	58.90	1	77.4	6.6	5
SA51A	SA51CA	51.0	56.70	62.70	1	82.4	6.2	5
SA54A	SA54CA	54.0	60.00	66.30	1	87.1	5.0	5
SA58A	SA58CA	58.0	64.40	71.20	1	93.6	5.4	5
SA60A	SA60CA	60.0	66.70	73.70	1	96.8	5.3	5
SA64A	SA64CA	64.0	71.10	78.60	1	103.0	5.0	5
SA70A	SA70CA	70.0	77.80	86.00	1	113.0	4.5	5
SA75A	SA75CA	75.0	83.30	92.10	1	121.0	4.2	5
SA78A	SA78CA	78.0	86.70	95.80	1	126.0	4.0	5
SA85A	SA85CA	85.0	94.40	104.00	1	137.0	3.7	5
SA90A	SA90CA	90.0	100.00	111.00	1	146.0	3.5	5
SA100A	SA100CA	100.0	111.00	123.00	1	162.0	3.1	5
SA110A	SA110CA	110.0	122.00	135.00	1	177.0	2.0	5
SA120A	SA120CA	120.0	133.00	147.00	1	193.0	2.6	5
SA130A	SA130CA	130.0	144.00	159.00	1	209.0	2.4	5
SA150A	SA150CA	150.0	167.00	185.00	1	243.0	2.1	5
SA160A	SA160CA	160.0	178.00	197.00	1	259.0	2.0	5
SA170A	SA170CA	170.0	189.00	209.00	1	275.0	1.9	5
SA180A	SA180CA	180.0	200.00	233.00	1	289.0	1.7	5

# Transient Voltage Suppressors - SA Series

## Ratings and Characteristic Curves

Figure 1 - Peak Pulse Power Rating Curve

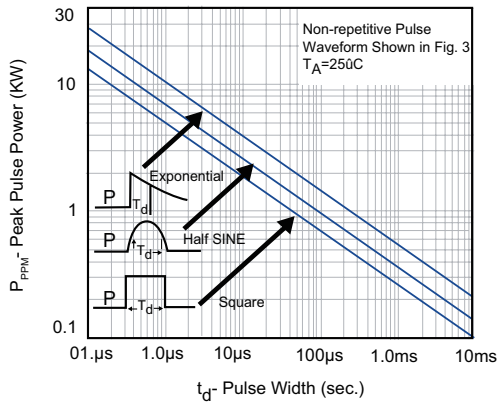

Figure 2 - Pulse Derating Curve

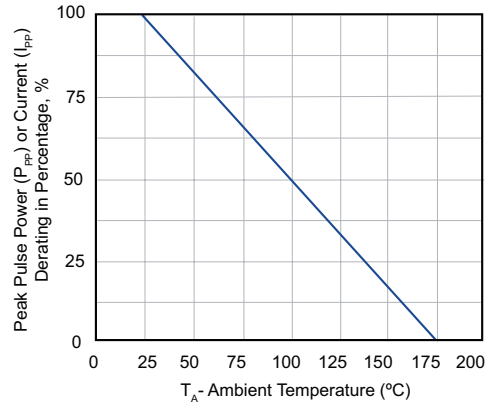

Figure 3 - Pulse Waveform

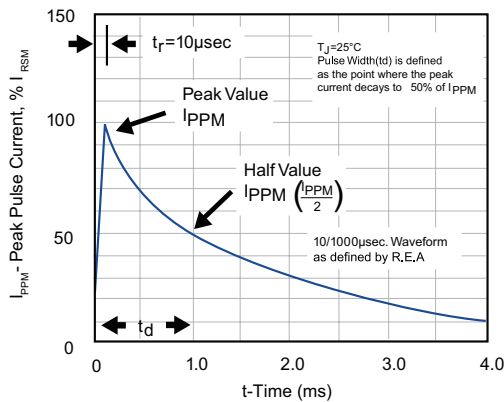

Figure 4 - Typical Junction Capacitance

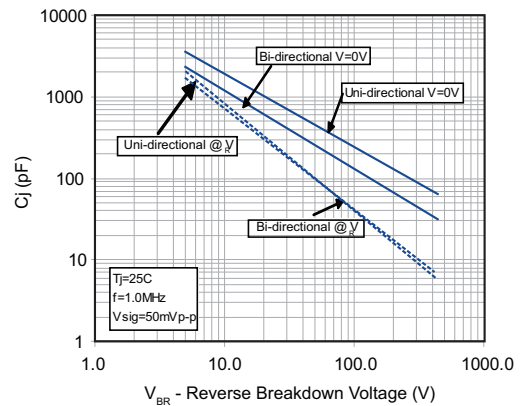

Figure 5 - Steady State Power Derating Curve

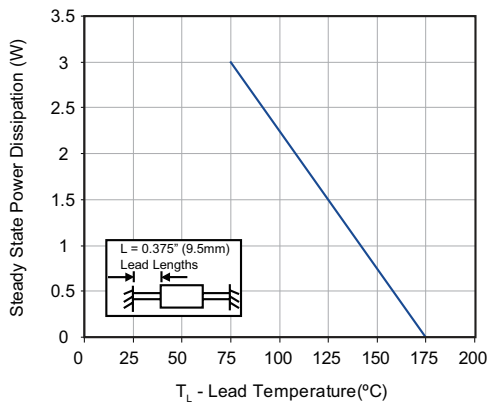
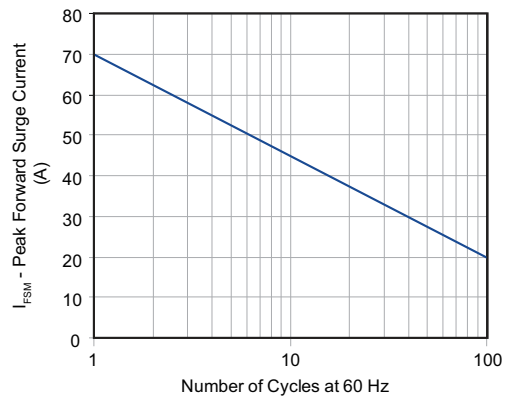

Figure 6 - Maximum Non-Repetitive Peak Forward Surge Current



# Transient Voltage Suppressors - SA Series

## Soldering Parameters

	Reflow Condition	Lead-free assembly
Pre Heat	- Temperature Min ( $T_{s(min)}$ )	150°C
	- Temperature Max ( $T_{s(max)}$ )	200°C
	- Time (min to max) ( $t_s$ )	60-180 secs
Average ramp up rate (Liquidus Temp ( $T_L$ ) to peak)		3°C/second max
$T_{s(max)}$ to $T_L$ - Ramp-up Rate		3°C/second max
Reflow	- Temperature ( $T_L$ ) (Liquidus)	217°C
	- Time (min to max) ( $t_s$ )	60-150 seconds
Peak Temperature ( $T_p$ )		260 <sup>+0/-5</sup> °C
Time within 5°C of actual peak Temperature ( $t_p$ )		20-40 seconds
Ramp-down Rate		6°C/second max
Time 25°C to peak Temperature ( $T_p$ )		8 minutes Max.
Do not exceed		280°C

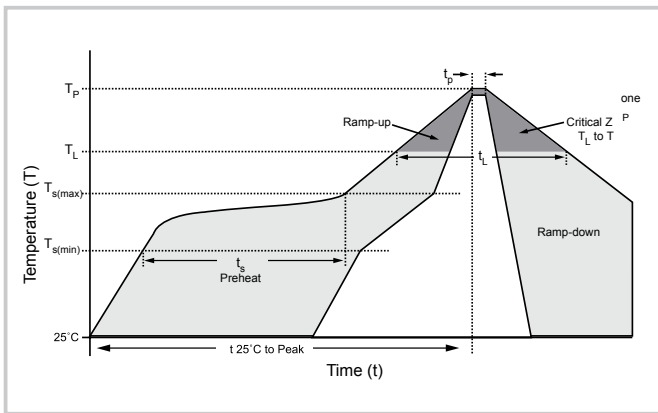

## Physical Specifications

Weight	0.045oz., 1.2g
Case	JEDEC DO-201 molded plastic body over passivated junction.
Polarity	Color band denotes the cathode except Bipolar.
Termina	Matte Tin axial leads, solderable per JESD22-B102D.

## Environmental Specifications

Temperature Cycle	JESD22-A104
Pressure Cooker	JESD 22-A102
High Temp. Storage	JESD22-A103
HTRB	JESD22-A108
Thermal Shock	JESD22-A106

## Flow/Wave Soldering

Peak Temperature :	265°C
Dipping Time :	10 seconds
Soldering :	1 time

## Transient Voltage Suppressors - SA Series

### Dimensions

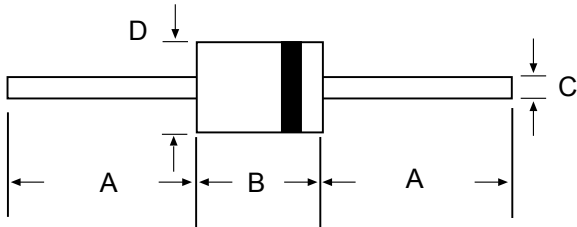

DO-204AC (DO-15)

Unit:mm

DIM	Inches		Millimeters	
	Min	Max	Min	Max
A	1.000	-	25.40	-
B	0.230	0.300	5.80	7.60
C	0.028	0.034	0.71	0.86
D	0.104	0.140	2.60	3.60

### Part Numbering System

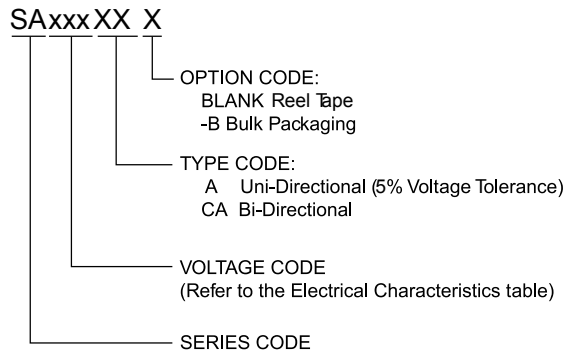

### Packaging

Part Number	Component Package	Quantity	Packaging Option	Packaging Specification
SAxxxXX	DO-204AC	2000	Tape & Reel	ELA STD RS-296E
SAxxxXX-B	DO-204AC	500	BULK	Concord Packing Spec

### Warehouse Storage Conditions of Products

- Storage Conditions:
  1. Storage Temperature: -10°C~+40°C
  2. Relative Humidity: ≤75%RH
  3. Keep away from corrosive atmosphere and sunlight.
- Period of Storage: 1 year

## RuiLongYuan Electronics Co., Ltd.

---

- Reproducing and modifying information of the document is prohibited without permission from Ruilongyuan International Inc.
- Ruilongyuan International Inc. reserves the rights to make changes of the content herein the document anytime without notification. Please refer to our website for the latest document.
- Ruilongyuan International Inc. disclaims any and all liability arising out of the application or use of any product including damages incidentally and consequentially occurred.
- Ruilongyuan International Inc. does not assume any and all implied warranties, including warranties of fitness for particular purpose, non-infringement and merchantability.
- Applications shown on the herein document are examples of standard use and operation. Customers are responsible in comprehending the suitable use in particular applications. Ruilongyuan International Inc. makes no representation or warranty that such applications will be suitable for the specified use without further testing or modification.
- The products shown herein are not designed and authorized for equipments requiring high level of reliability or relating to human life and for any applications concerning life-saving or life-sustaining, such as medical instruments, transportation equipment, aerospace machinery et cetera. Customers using or selling these products for use in such applications do so at their own risk and agree to fully indemnify Ruilongyuan International Inc. for any damages resulting from such improper use or sale.

---

**Tel: +86-755-8290 8296**

**Fax: +86-755-8290 8002**

**E-mail: jack@ruilon.com**