

## DETAILS

<b>Product Number</b>	CA13156_EMERALD-A
<b>Family</b>	EMERALD
<b>Type</b>	Assembly
<b>Color</b>	clear
<b>Diameter</b>	21,6 mm
<b>Height</b>	7,3 mm
<b>Style</b>	round
<b>Optic Material</b>	PMMA
<b>Holder Material</b>	
<b>Fastening</b>	tape, pin
<b>Status</b>	production ready
<b>ROHS Compliant</b>	Yes
<b>Date Updated</b>	8/03/2016



## OPTICAL PROPERTIES

LED	Viewing	Light	Efficiency	cd/lm	Connector
	Angle	Beam			
XP-E	152+71 deg	Oval	93 %	2.800	-
XB-D	150+63 deg	Oval	88 %	2.300	-
XM-L	152+81 deg	Oval	91 %	1.200	-
XP-G	153+92 deg	Oval	88 %	1.900	-
XT-E	150+64 deg	Oval	88 %	2.000	-
XP-E2	153+70 deg	Oval	93 %	2.900	-
XM-L2	167+71 deg	Oval	92 %	1.200	-
XP-G2	151+75 deg	Oval	91 %	2.040	-
H35C0 (LEMWA33)	153+68 deg	Oval	90 %	1.600	-
H35B0 (LEMWA32)	153+64 deg	Oval	93 %	2.000	-
LUXEON A	151+73 deg	Oval	89 %	1.750	-
LUXEON Rebel	146+64 deg	Oval	88 %	2.900	-
LUXEON R	147+71 deg	Oval	88 %	1.900	-
LUXEON Rebel ES	147+73 deg	Oval	88 %	1.900	-
LUXEON T	151+75 deg	Oval	93 %	1.800	-
LUXEON TX	151+71 deg	Oval	92 %	1.850	-
NCSxx19A	145+64 deg	Oval	88 %	2.200	-
NVSxx19A	147+70 deg	Oval	87 %	1.850	-
NS9x383	150+82 deg	Oval	89 %	1.000	-
NVSxx19B/NVSxx19C	151+77 deg	Oval	87 %	1.600	-
Oslon Square EC	150+76 deg	Oval	89 %	1.850	-
Oslon Square PC	150+86 deg	Oval	89 %	2.000	-
Oslon SSL 150	152+99 deg	Oval	92 %	2.900	-
Oslon SSL 80	148+53 deg	Oval	89 %	2.300	-
Oslon Square Gen3	152+76 deg	Oval	90 %	1.780	-



**PRODUCT DATASHEET**  
**EMERALD series**  
last update 8/3/2016

## OPTICAL PROPERTIES

LED	Viewing Angle	Light Beam	Effi- ciency	cd/lm	Connector
Z5	TBA deg	Oval	89 %	-	-

INDEX	PART NO	DESCRIPTION	MATERIAL
1	CA13156	EMERALD-A	PMMA + PU FOAM adhesive tape

4

Isometric view  
Scale: 2:1

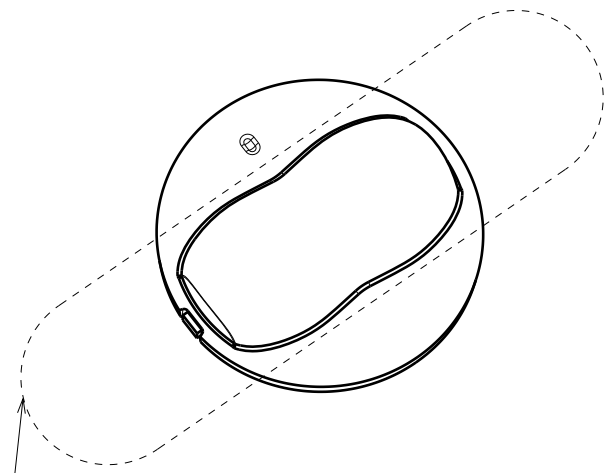

3

Beam pattern direction

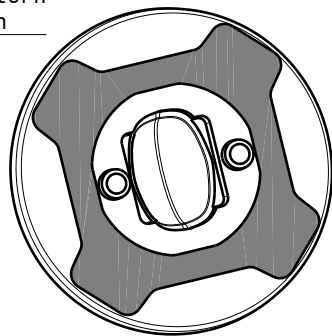

2

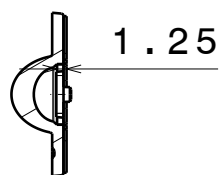

Section view A-A  
Scale: 1:1

Bottom view

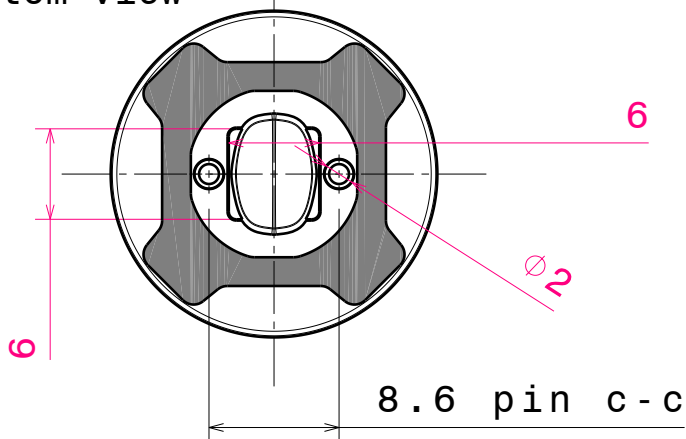

Front view

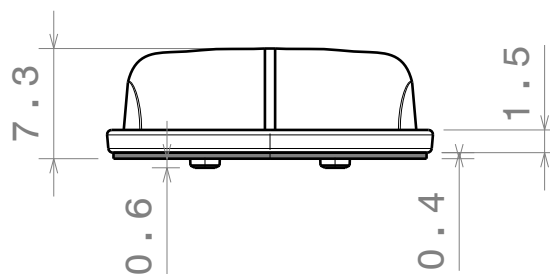

Top view

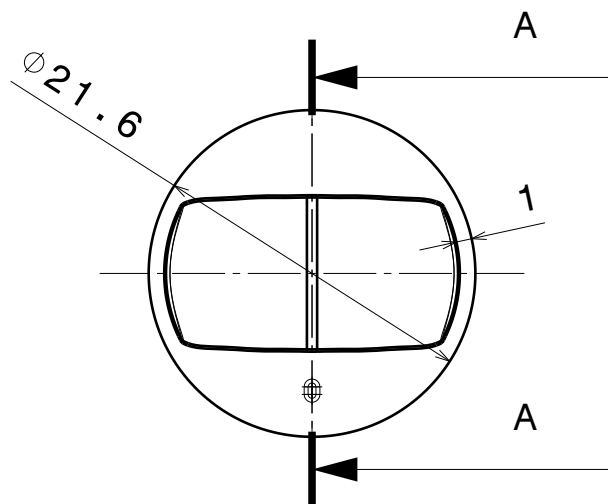

This drawing is our property.  
It can't be reproduced  
or communicated without  
our written agreement.

**LEDiL**

Ledil Oy  
Salorankatu 10  
FIN 24240 SALO  
Finland

DATASHEET TITLE

Mechanical Drawing

DRAWN BY

ol

DATE

18.12.2012

CA13156 EMERALD-A

CHECKED BY

as

DATE

18.12.2012

SIZE

A4

PART NUMBER

CA13156

REV

001

DESIGNED BY

ol

DATE

3.10.2012

SCALE

2:1

WEIGHT

SHEET

1/1

D

A

4

3

2

1

# LEDiL Oy CA13156\_EMERALD-A\_(XP-E) Eff.91.5% / LDC (Linear)

Luminaire: LEDiL Oy CA13156\_EMERALD-A\_(XP-E) Eff.91.5%  
Lamps: 1 x CREE XP-E (51.4197lm@250mA)

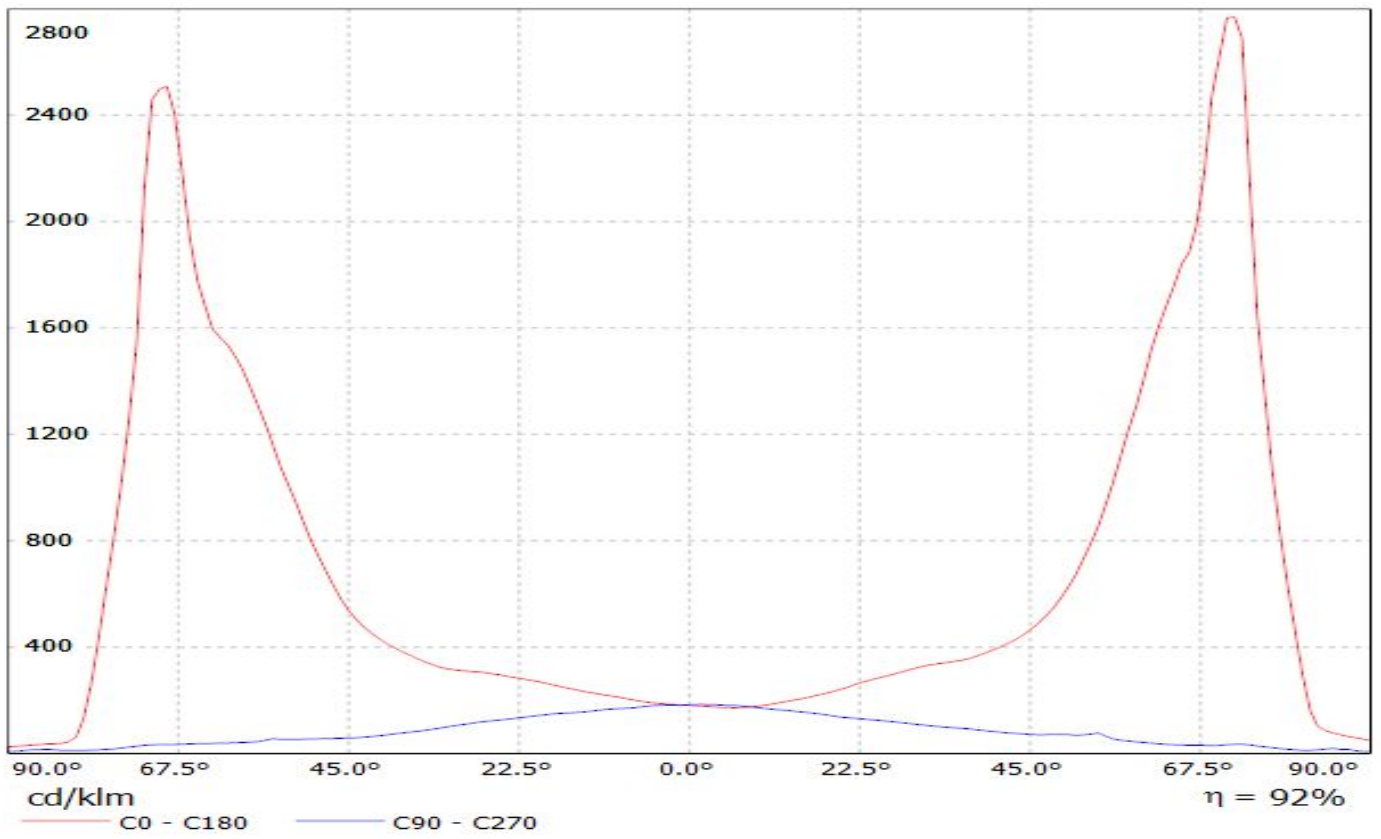

# LEDiL Oy CA13156\_EMERALD-A\_(XB-D) Eff.87.8% / LDC (Linear)

Luminaire: LEDiL Oy CA13156\_EMERALD-A\_(XB-D) Eff.87.8%  
Lamps: 1 x Cree XB-D (95lm@250mA)

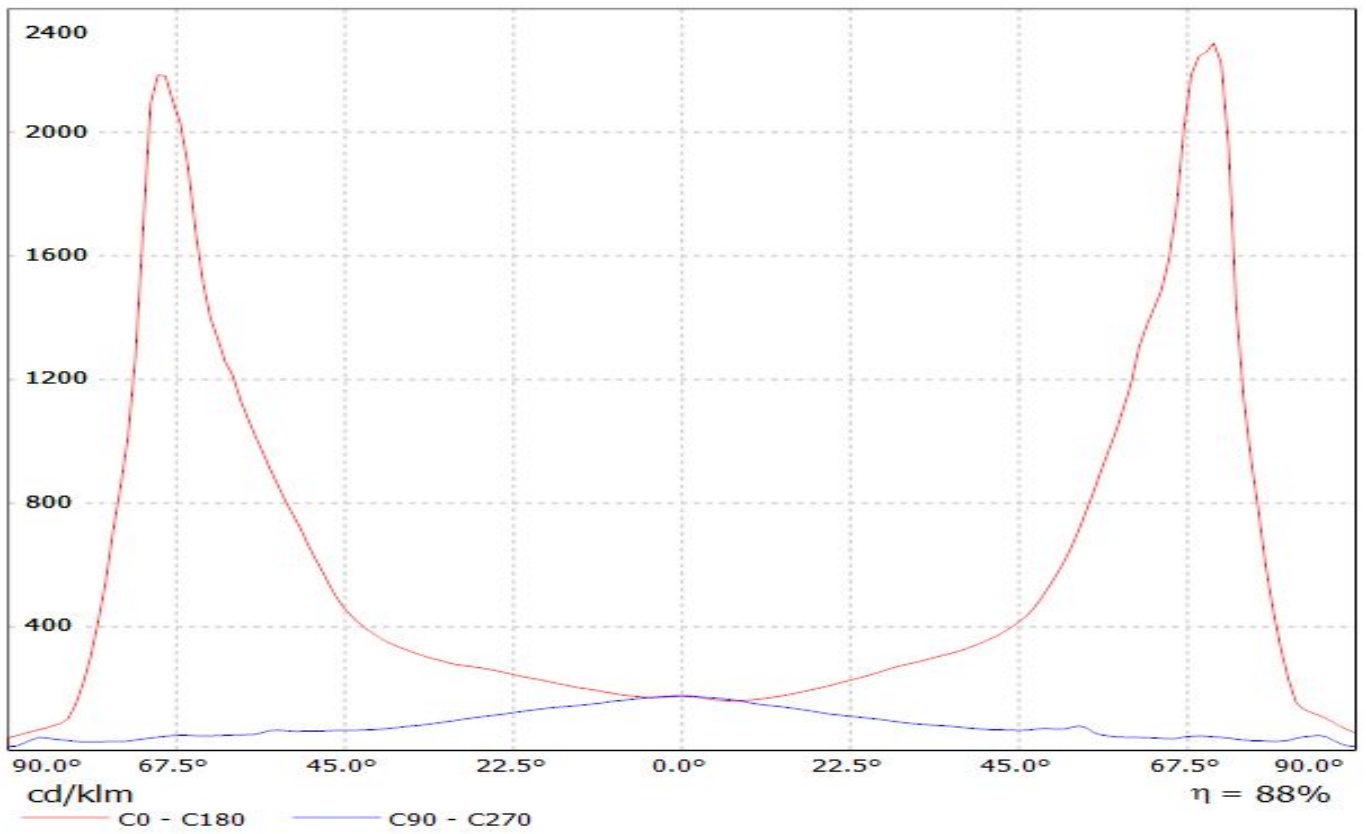

# LEDiL Oy CA13156\_EMERALD-A\_(XM-L) Eff.90.8% / LDC (Linear)

Luminaire: LEDiL Oy CA13156\_EMERALD-A\_(XM-L) Eff.90.8%  
Lamps: 1 x Cree XM-L (91.7822lm@250mA)

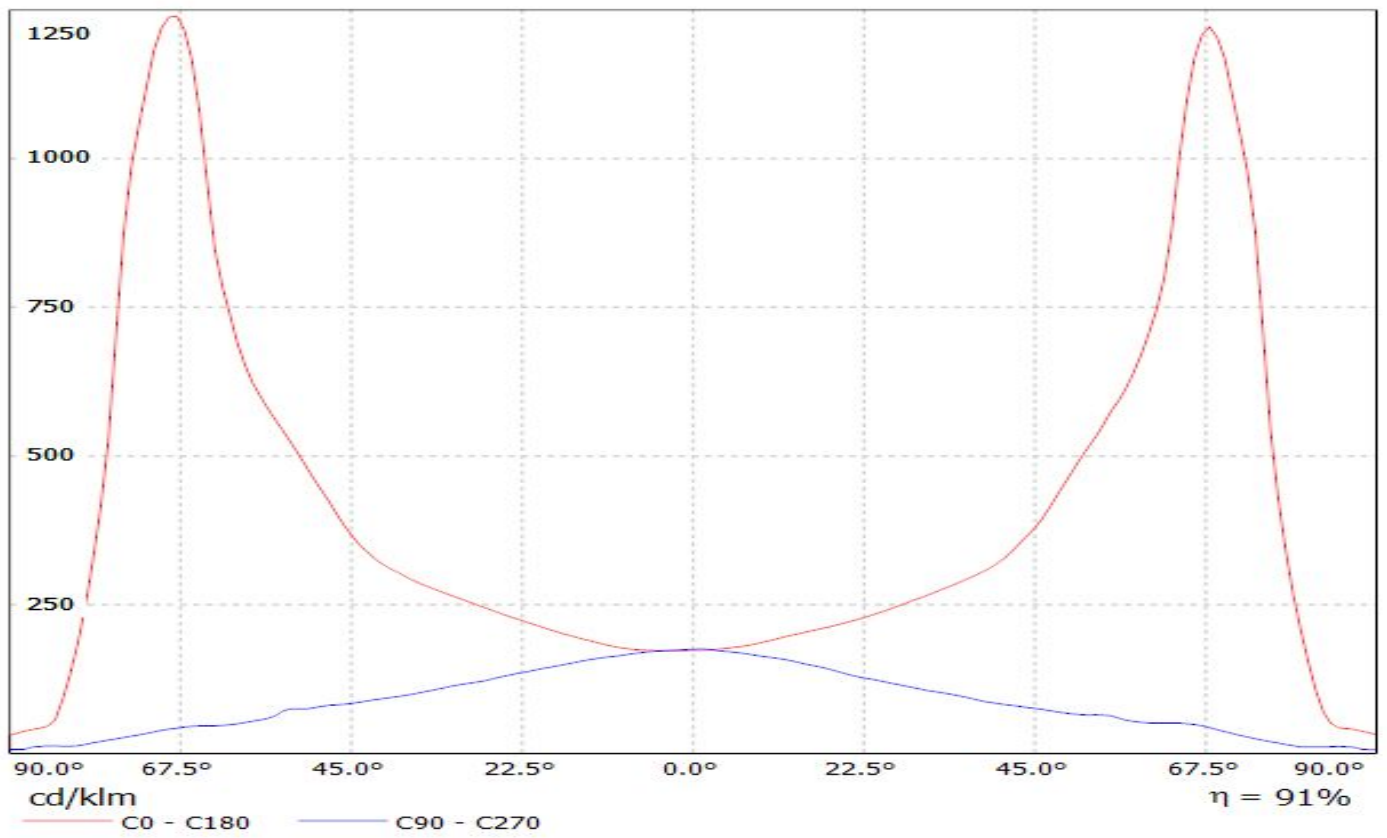

# LEDiL Oy CA13156\_EMERALD-A\_(XP-G) Eff.88.1% / LDC (Linear)

Luminaire: LEDiL Oy CA13156\_EMERALD-A\_(XP-G) Eff.88.1%  
Lamps: 1 x XP-G (70.6lm@250mA)

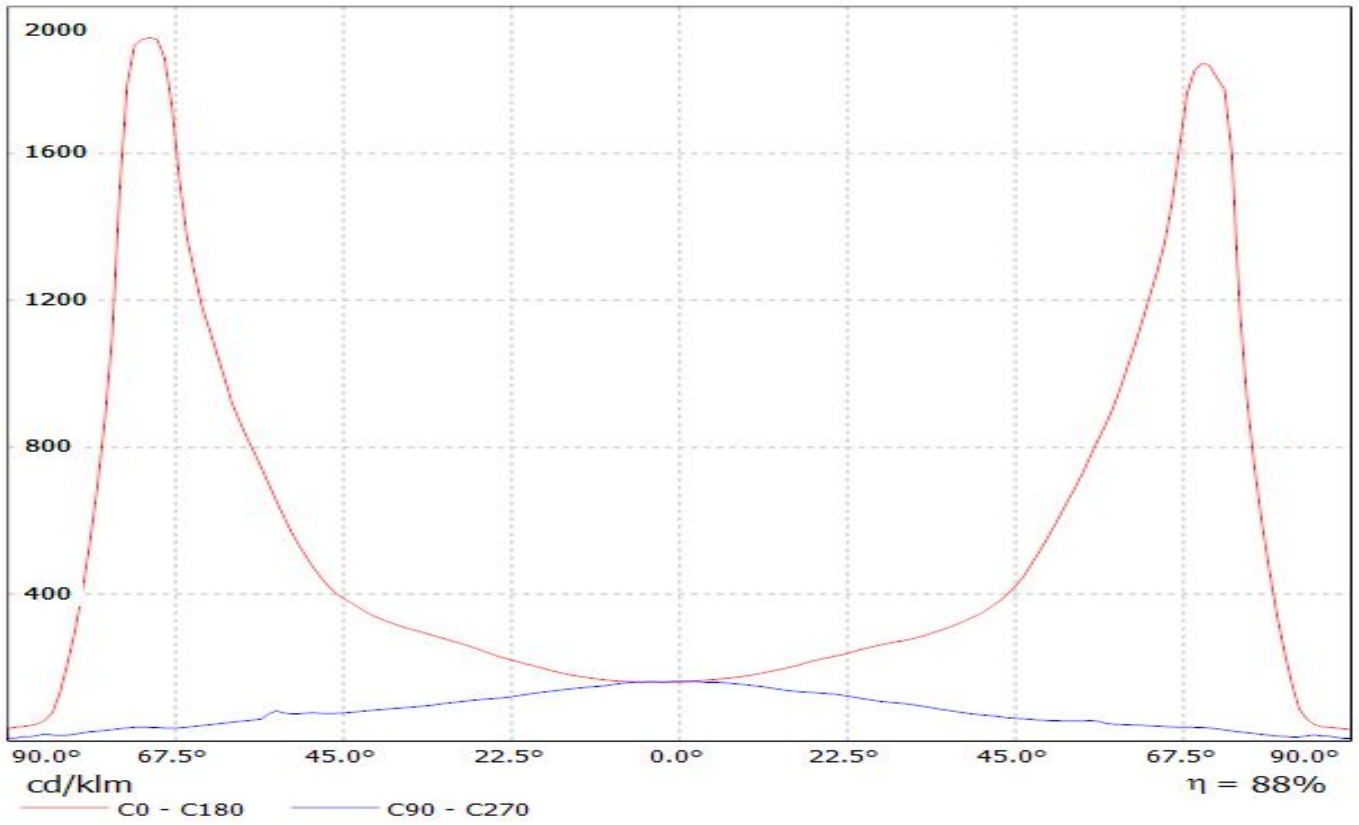

# LEDiL Oy CA13156\_EMERALD-A\_(XT-E) Eff.88.2% / LDC (Linear)

Luminaire: LEDiL Oy CA13156\_EMERALD-A\_(XT-E) Eff.88.2%

Lamps: 1 x Cree XT-E (102.3lm@250mA)

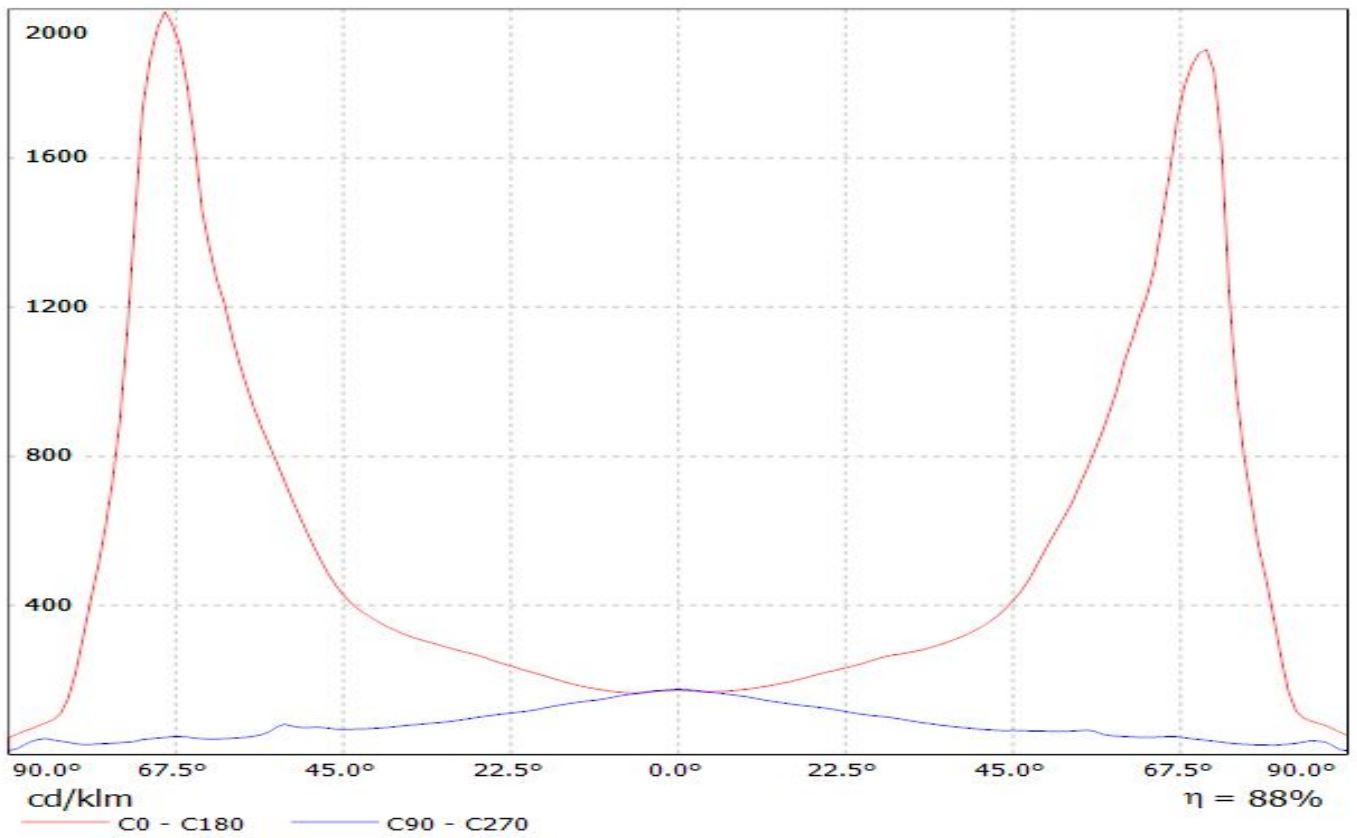



# LEDiL Oy CA13156\_EMERALD-A\_(XP-E2) Eff.91.7% / LDC (Linear)

Luminaire: LEDiL Oy CA13156\_EMERALD-A\_(XP-E2) Eff.91.7%  
Lamps: 1 x CREE XP-E2 (93.5lm@250mA)

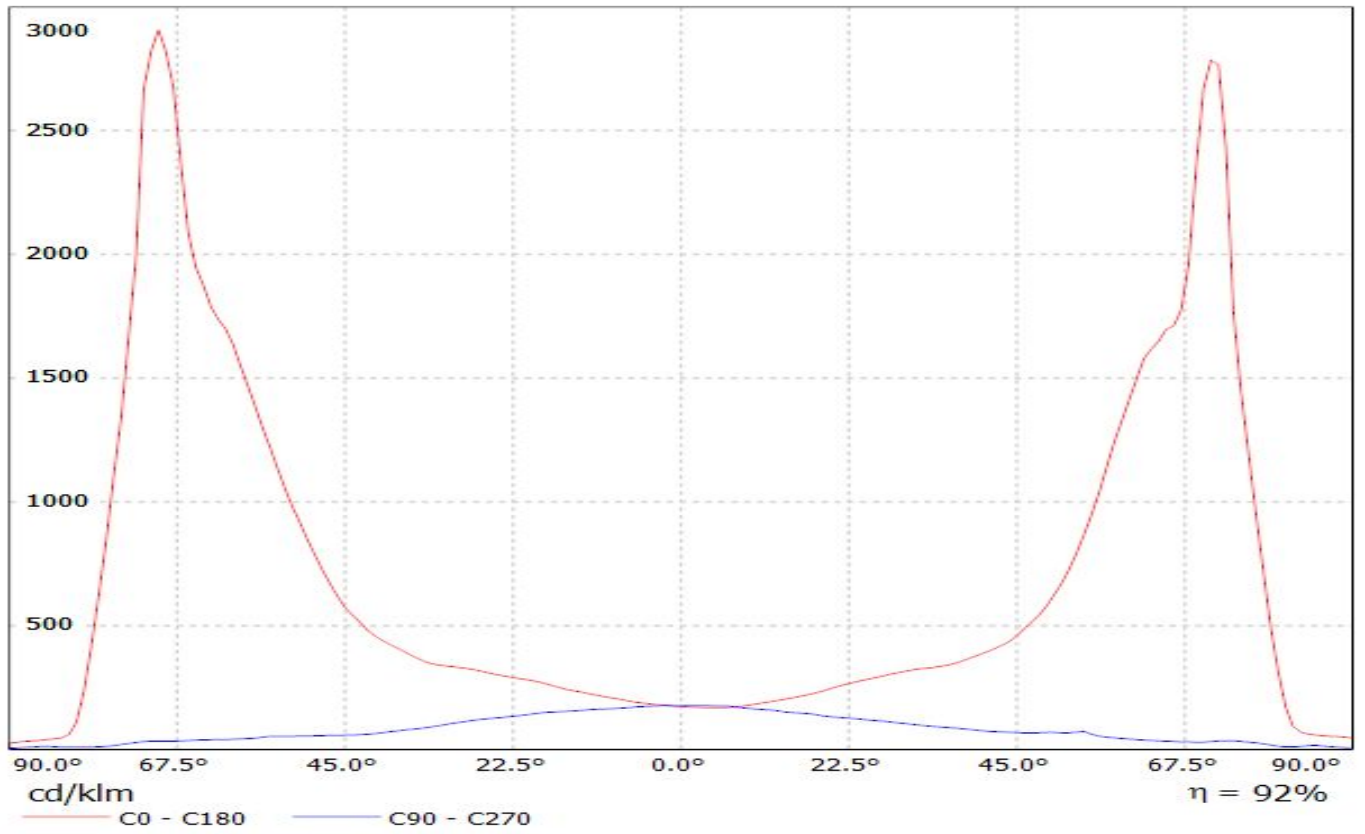

Luminaire: LEDil Oy CA13156\_EMERALD-A\_(XM-L2) Efficiency=92%  
Lamps: 1 x Cree XM-L2 (XMLBWT-0-7B4-T30-0L-0001) 91lm @ 250mA CCT=3200K P=0.7W I=250mA

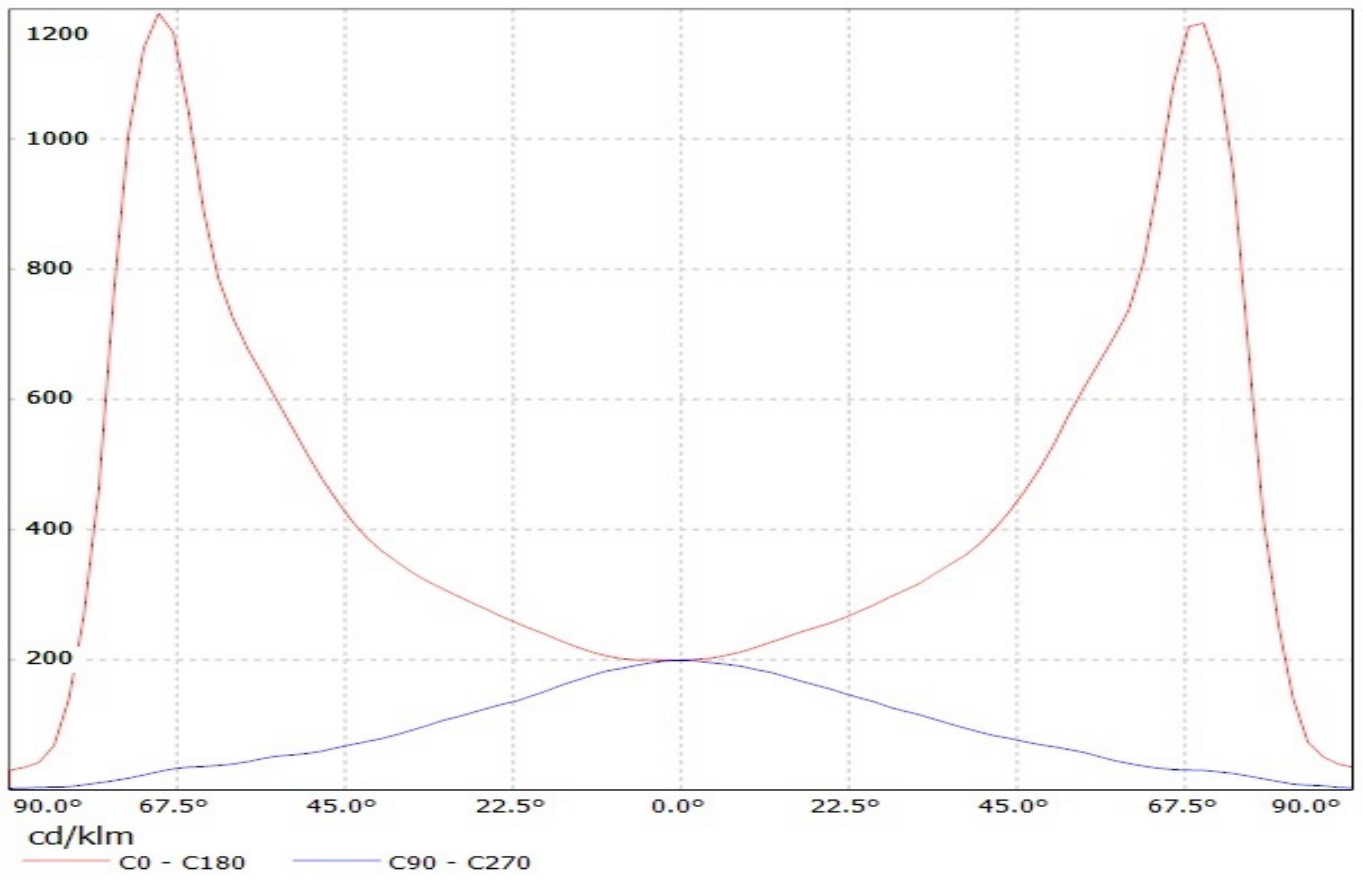

# LEDiL Oy CA13156\_EMERALD-A\_(XP-G2) Eff.91.4% / LDC (Linear)

Luminaire: LEDiL Oy CA13156\_EMERALD-A\_(XP-G2) Eff.91.4%  
Lamps: 1 x CREE XP-G2 (105.7lm@250mA)

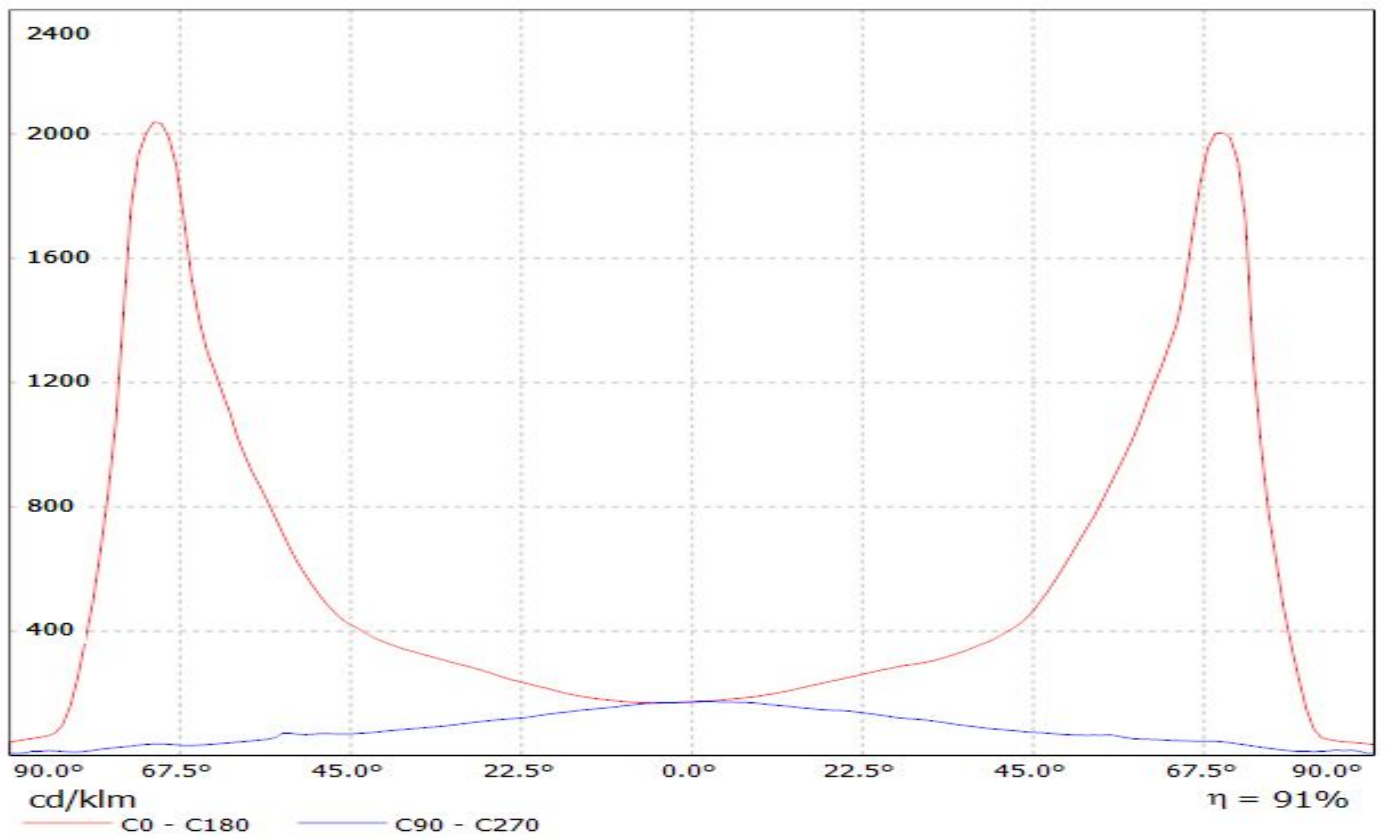

# LEDiL Oy CA13156\_EMERALD-A\_(LG3535) Eff.89.7% / LDC (Linear)

Luminaire: LEDiL Oy CA13156\_EMERALD-A\_(LG3535) Eff.89.7%  
Lamps: 1 x LG 3535 Ceramic (94lm@250mA)

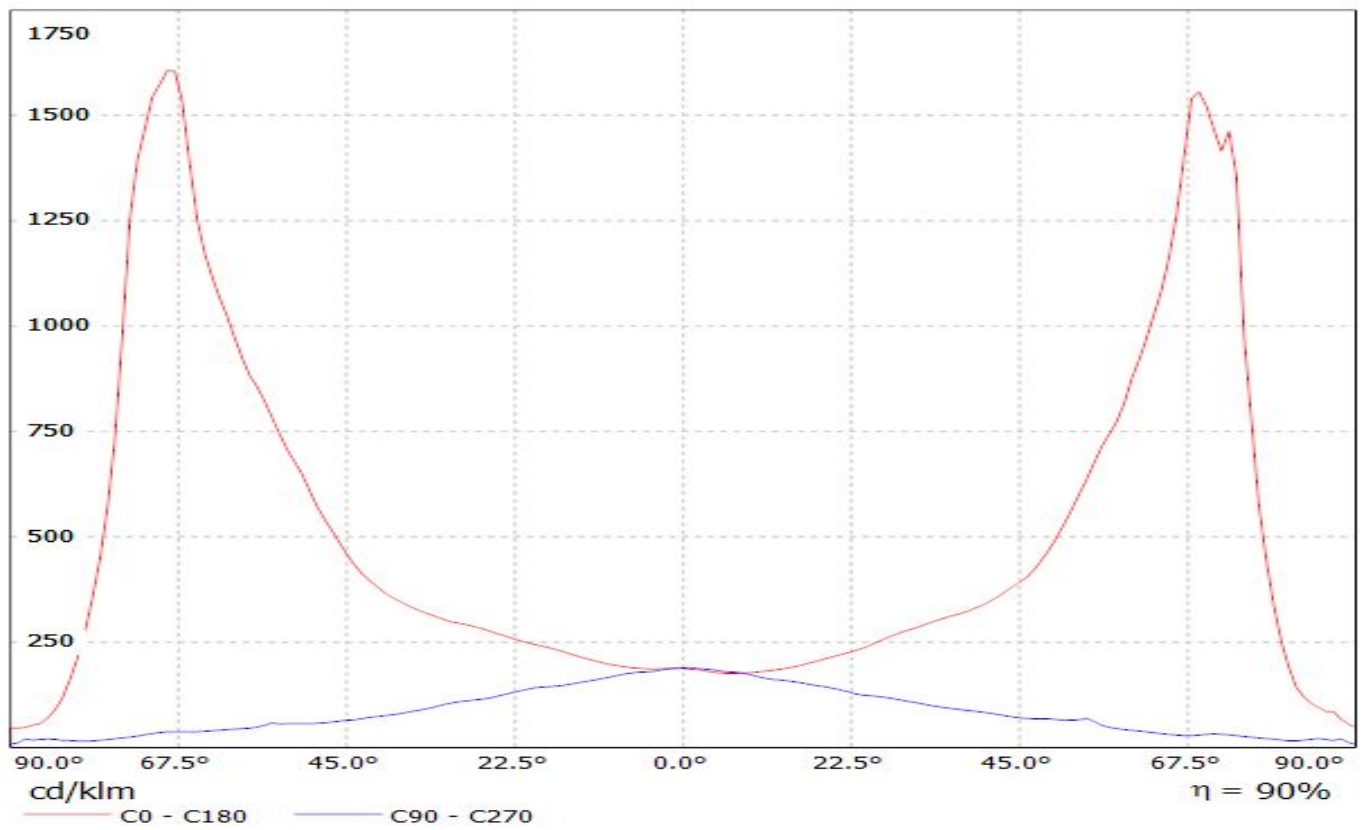

**LEDiL Oy CA13156\_EMERALD-A\_(LG3535\_2W) Eff.92.6% / LDC (Linear)**

Luminaire: LEDiL Oy CA13156\_EMERALD-A\_(LG3535\_2W) Eff.92.6%  
Lamps: 1 x LG3535\_2W (97.3629lm@250mA)

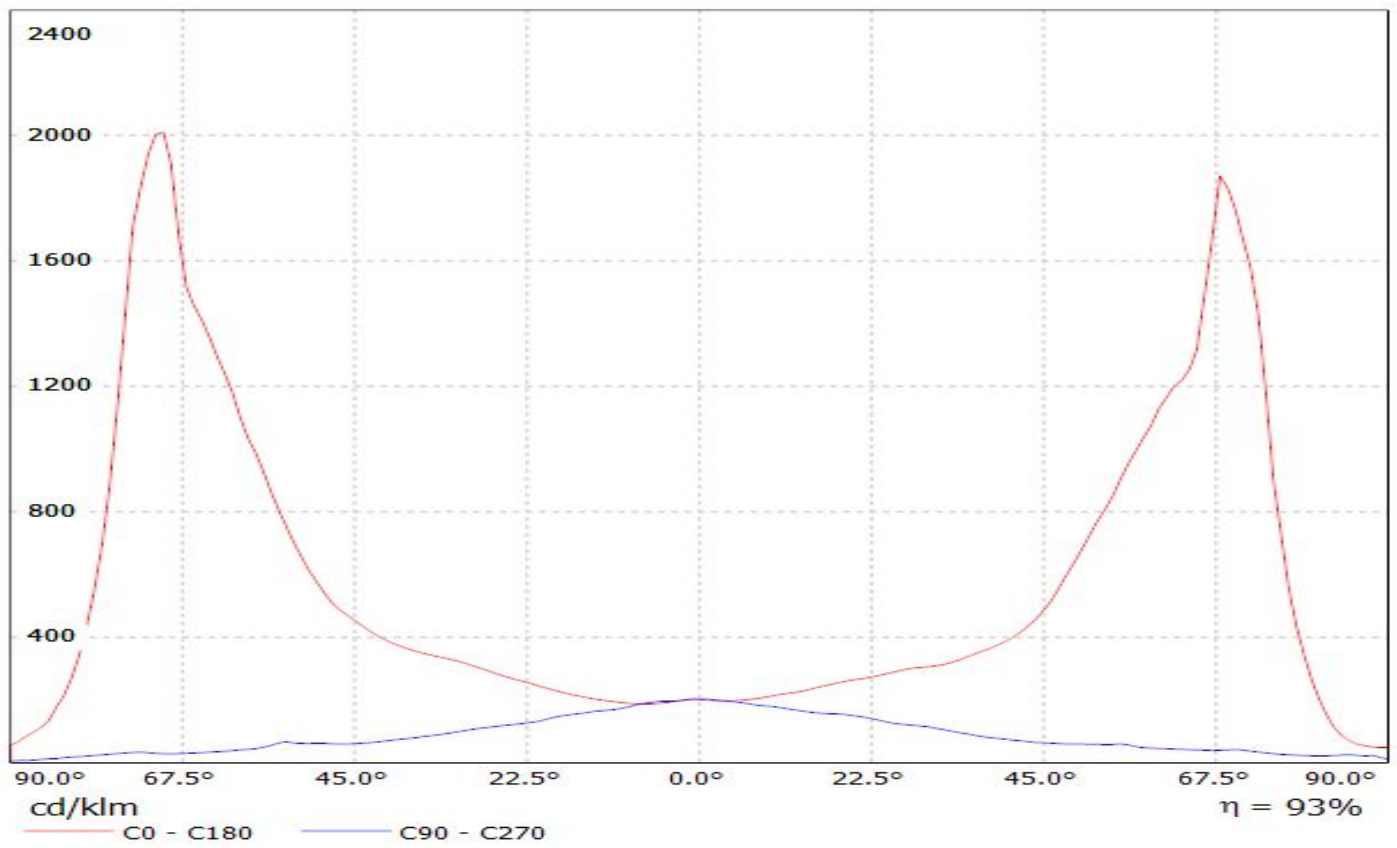

**LEDiL Oy CA13156\_EMERALD-A\_(LUXEON\_A) Eff.88.6% / LDC (Linear)**

Luminaire: LEDiL Oy CA13156\_EMERALD-A\_(LUXEON\_A) Eff.88.6%  
Lamps: 1 x LUXEON\_R (67.5lm@250mA)

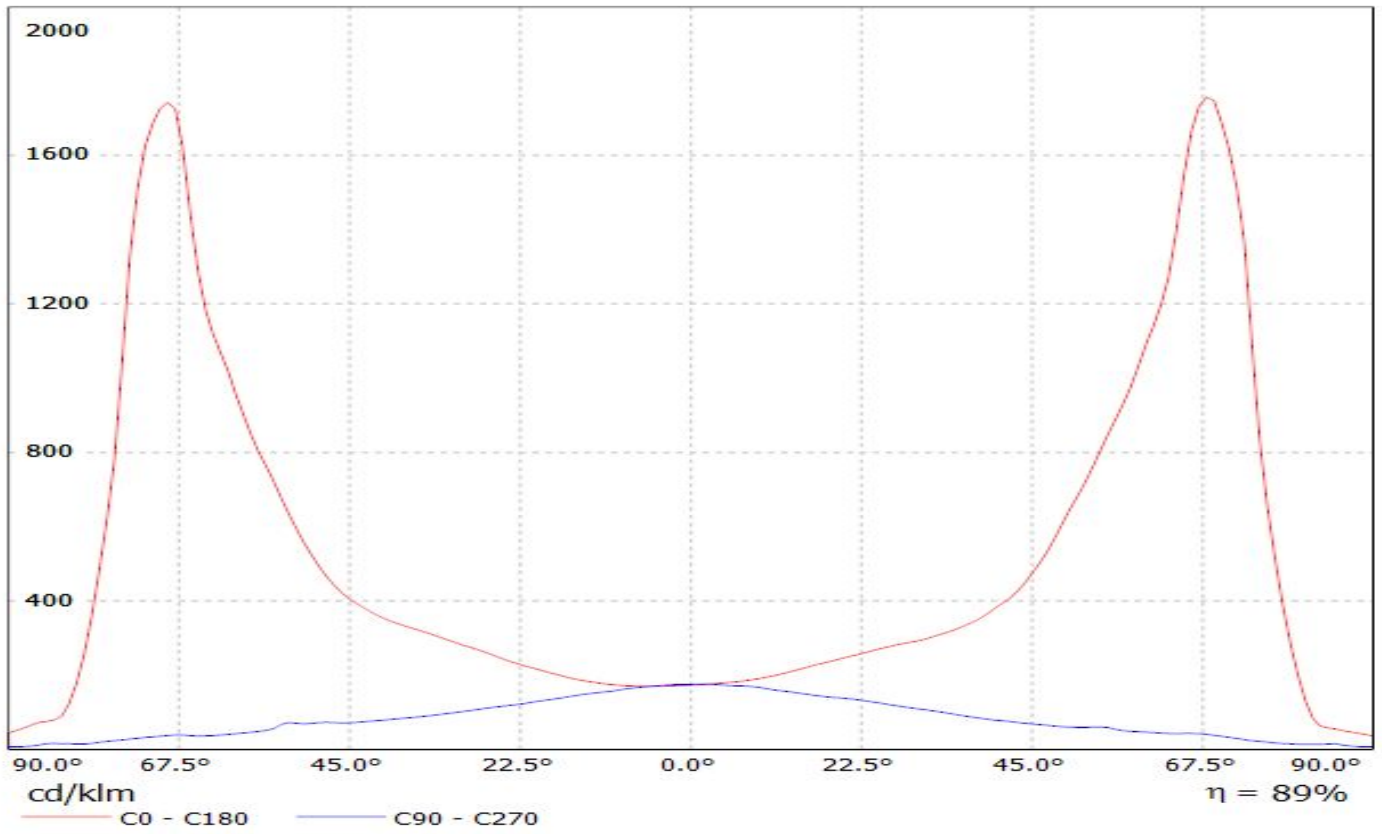

Luminaire: LEDiL Oy CA13156\_EMERALD-A\_(Rebel) Eff. 88,8%  
Lamps: 1 x Luxeon Rebel (82lm@250mA)

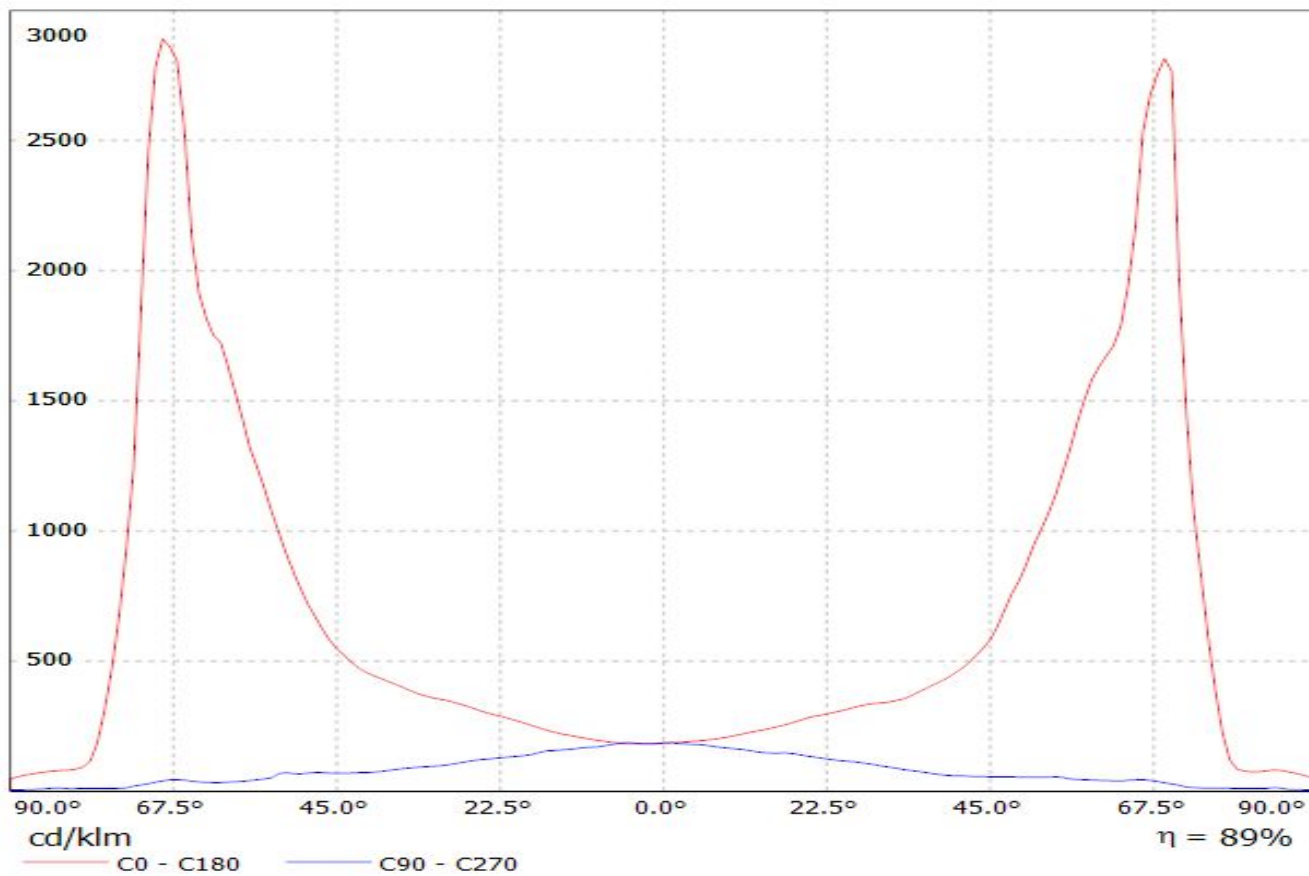

# LEDiL Oy CA13156\_EMERALD-A\_(LUXEON\_R) Eff.88.4% / LDC (Linear)

Luminaire: LEDiL Oy CA13156\_EMERALD-A\_(LUXEON\_R) Eff.88.4%  
Lamps: 1 x LUXEON\_R (85.6lm@250mA)

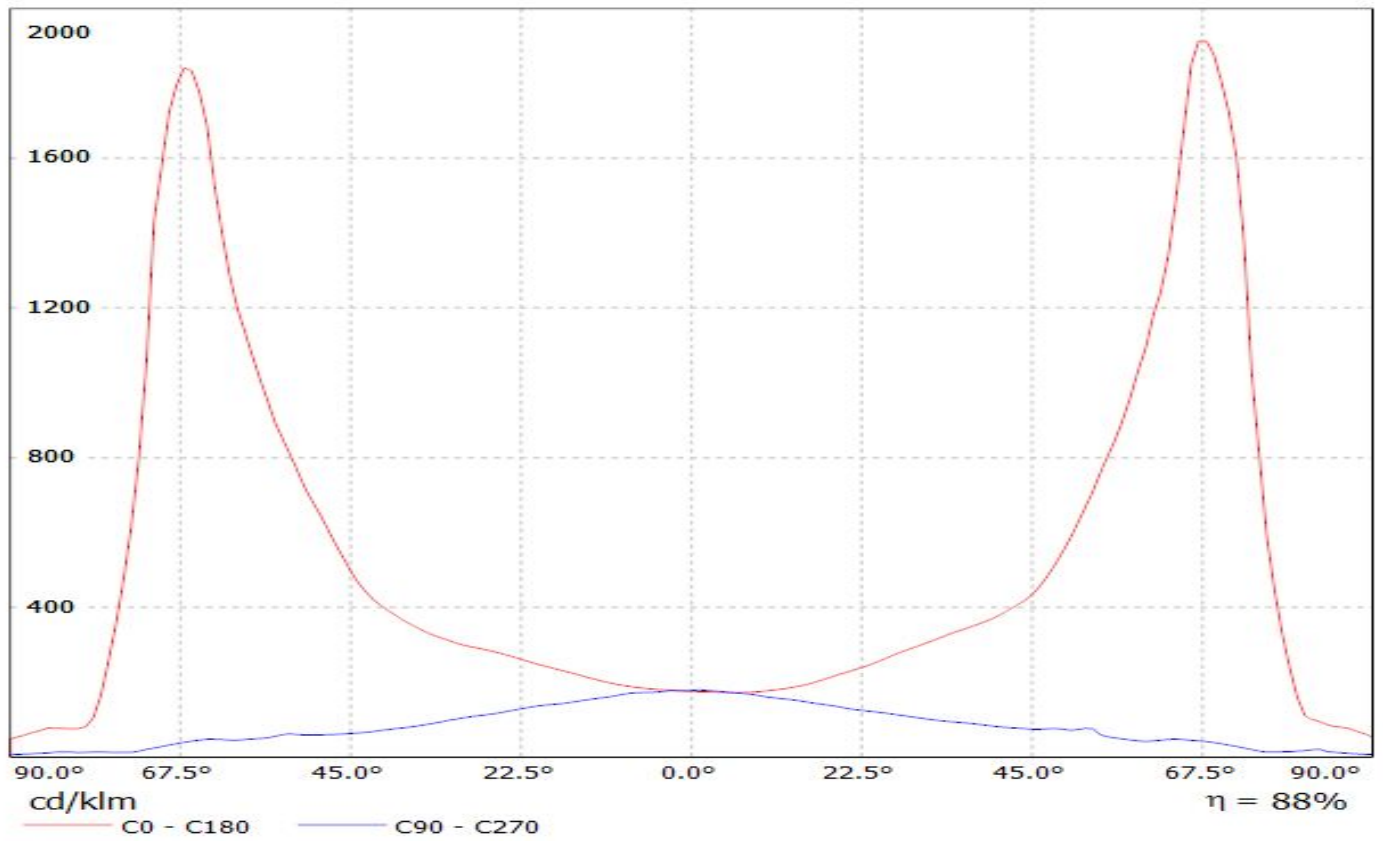



Luminaire: LEDiL Oy CA13156\_EMERALD-A\_(Rebel-ES) Eff. 88%  
Lamps: 1 x Luxeon Rebel-ES (90lm@250mA)

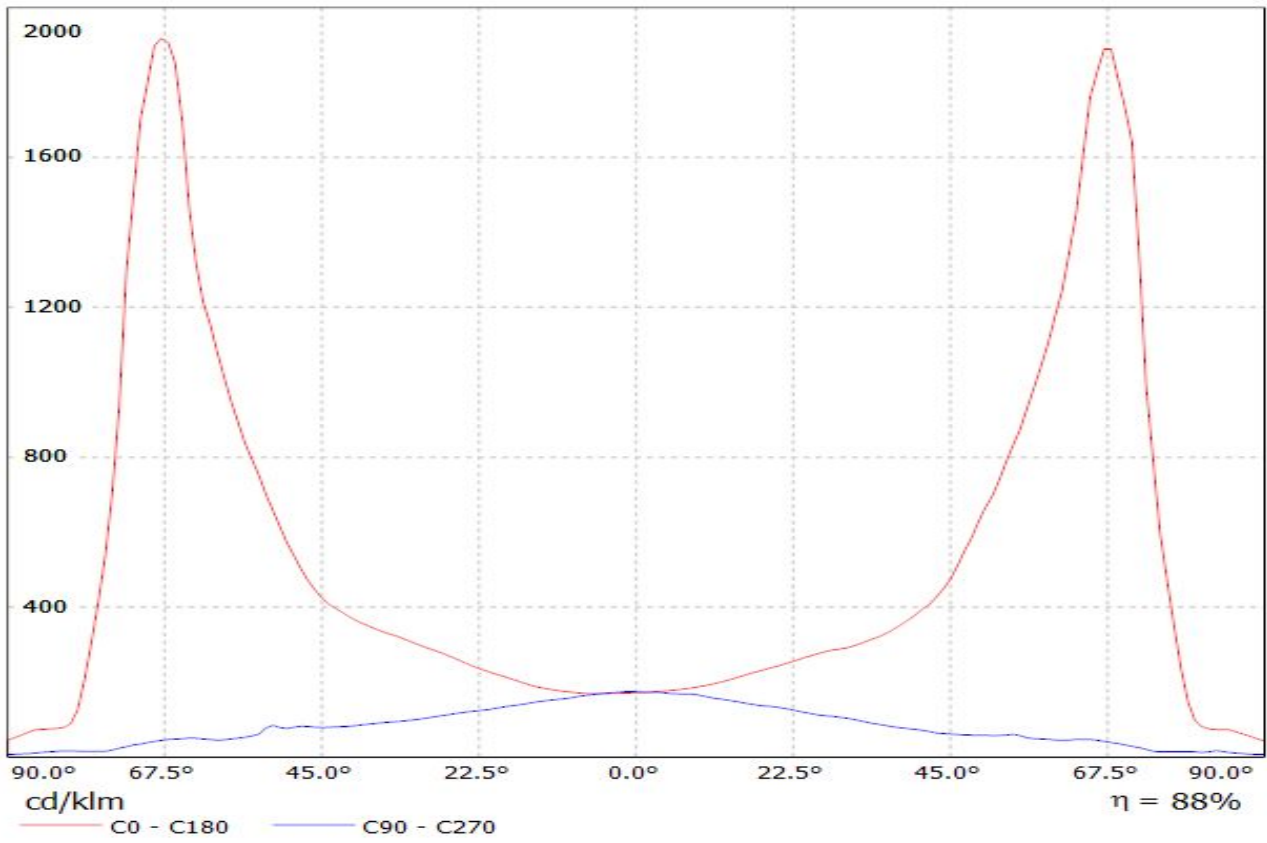

Luminaire: Ledil Oy CA13156\_EMERALD-A (Luxeon T 71lm @ 250mA) Efficiency=93%  
Lamps: 1 x Luxeon T 71lm @ 250mA

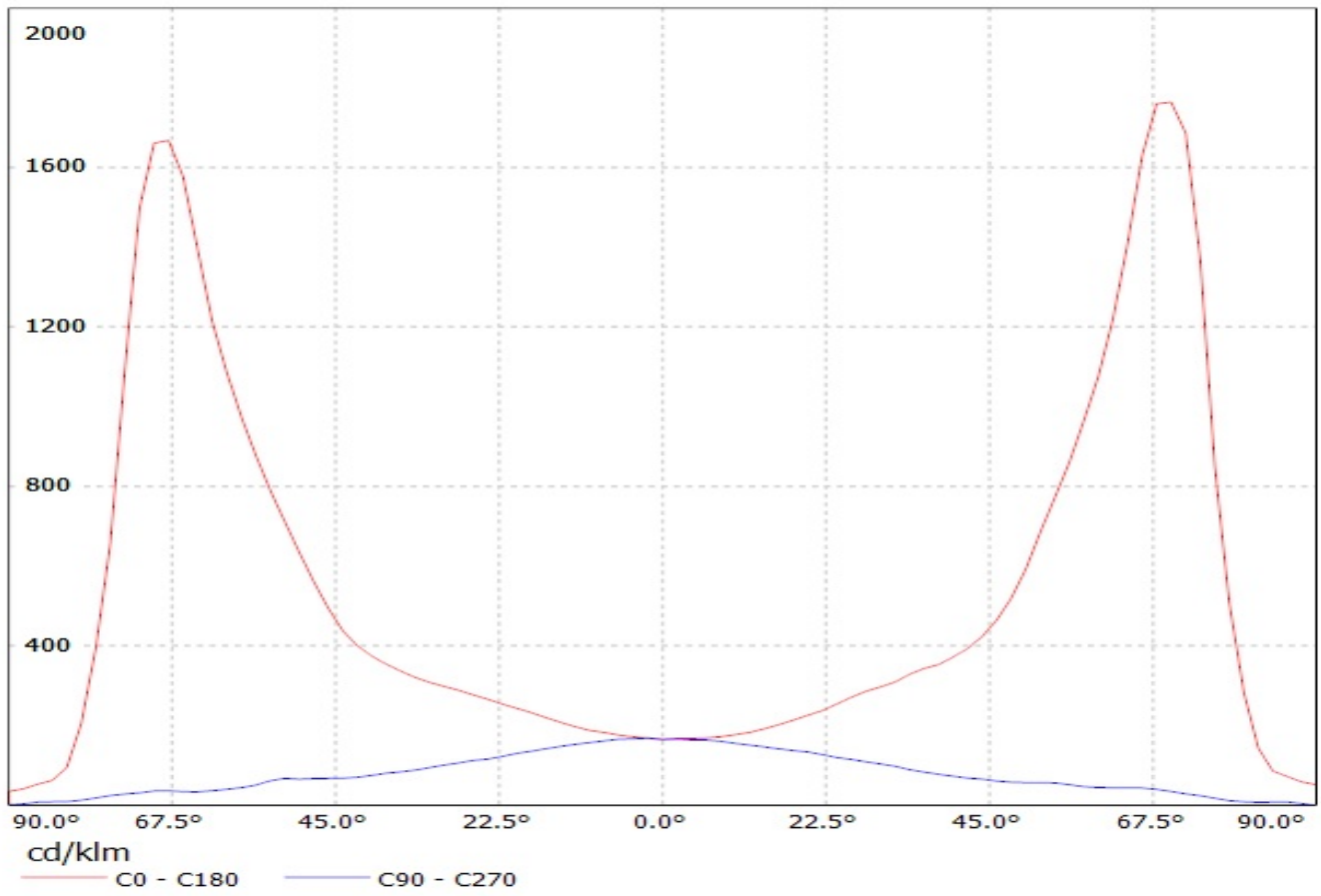

Luminaire: LEDiL Oy CA13156\_EMERALD-A (Luxeon\_TX) Eff.91.7%  
Lamps: 1 x Luxeon\_TX\_(L1T2-3585)\_80.1801lm@250mA\_CCT=3500K\_P=0.731482W\_I=249.9mA

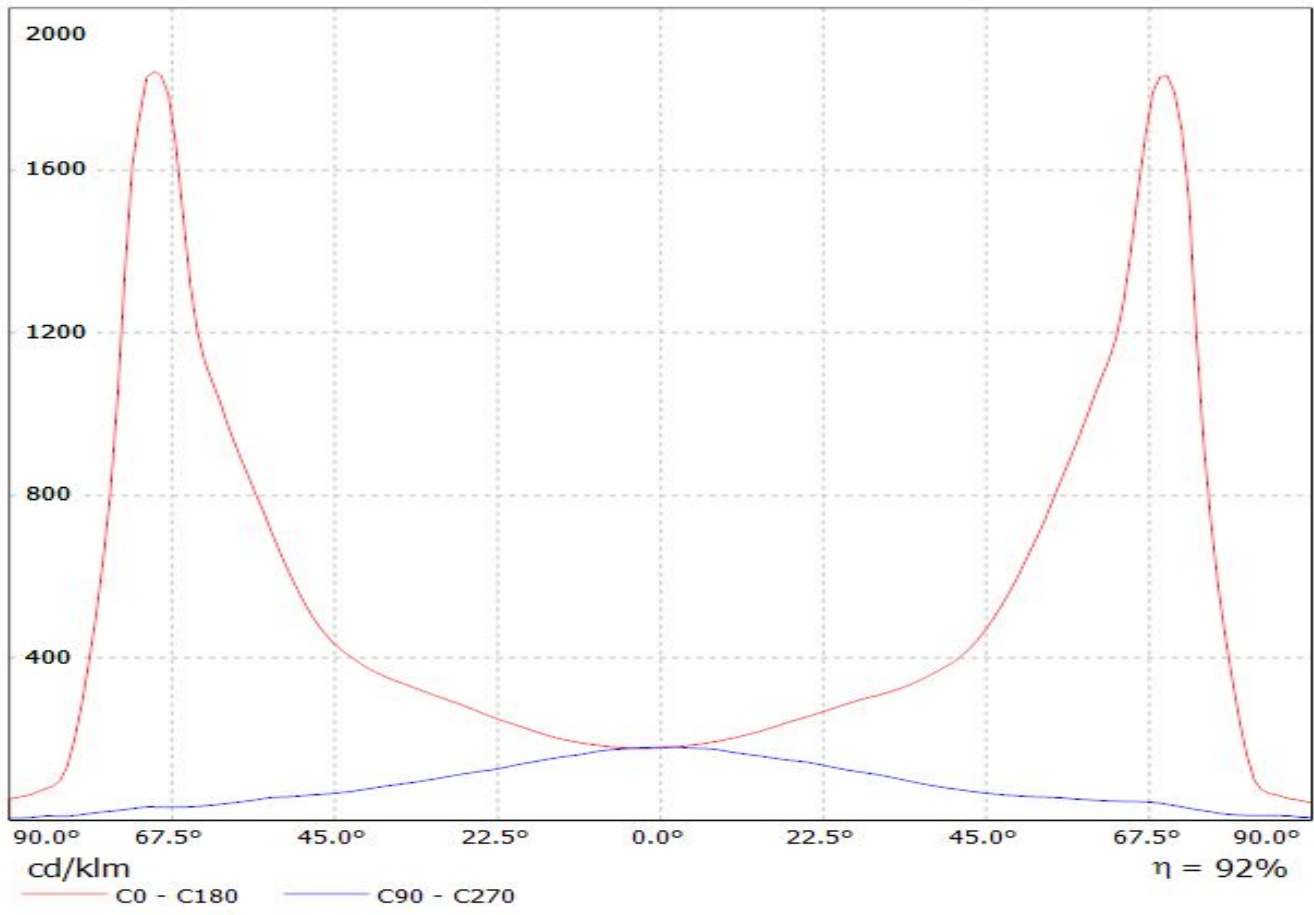

# LEDiL Oy CA13156\_EMERALD-A\_(NCS19) Eff.88.1% / LDC (Linear)

Luminaire: LEDiL Oy CA13156\_EMERALD-A\_(NCS19) Eff.88.1%  
Lamps: 1 x NCS19 (89lm@250mA)

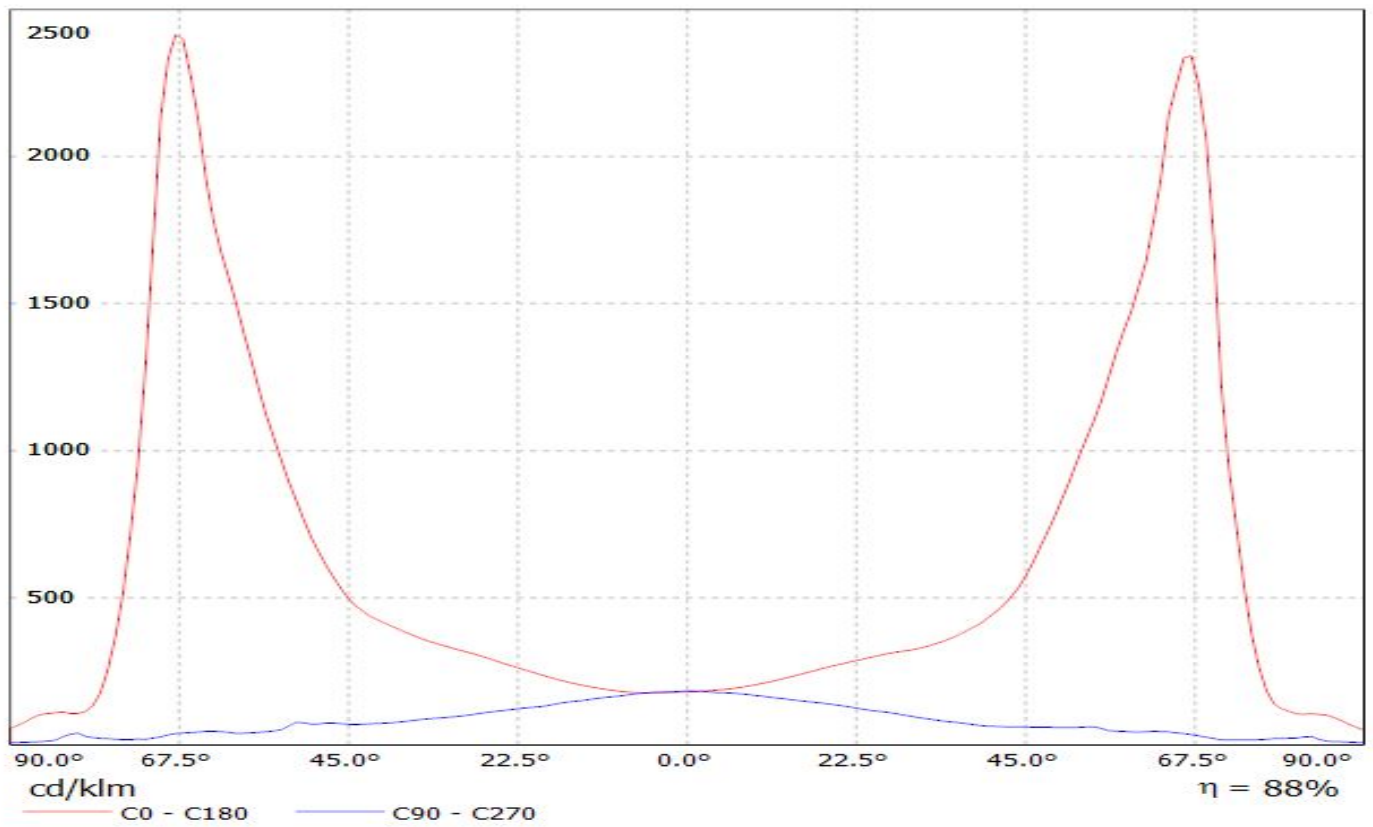

# LEDiL Oy CA13156\_EMERALD-A\_(NVS19) Eff.87.5% / LDC (Linear)

Luminaire: LEDiL Oy CA13156\_EMERALD-A\_(NVS19) Eff.87.5%  
Lamps: 1 x NVS19 (98.3lm@250mA)

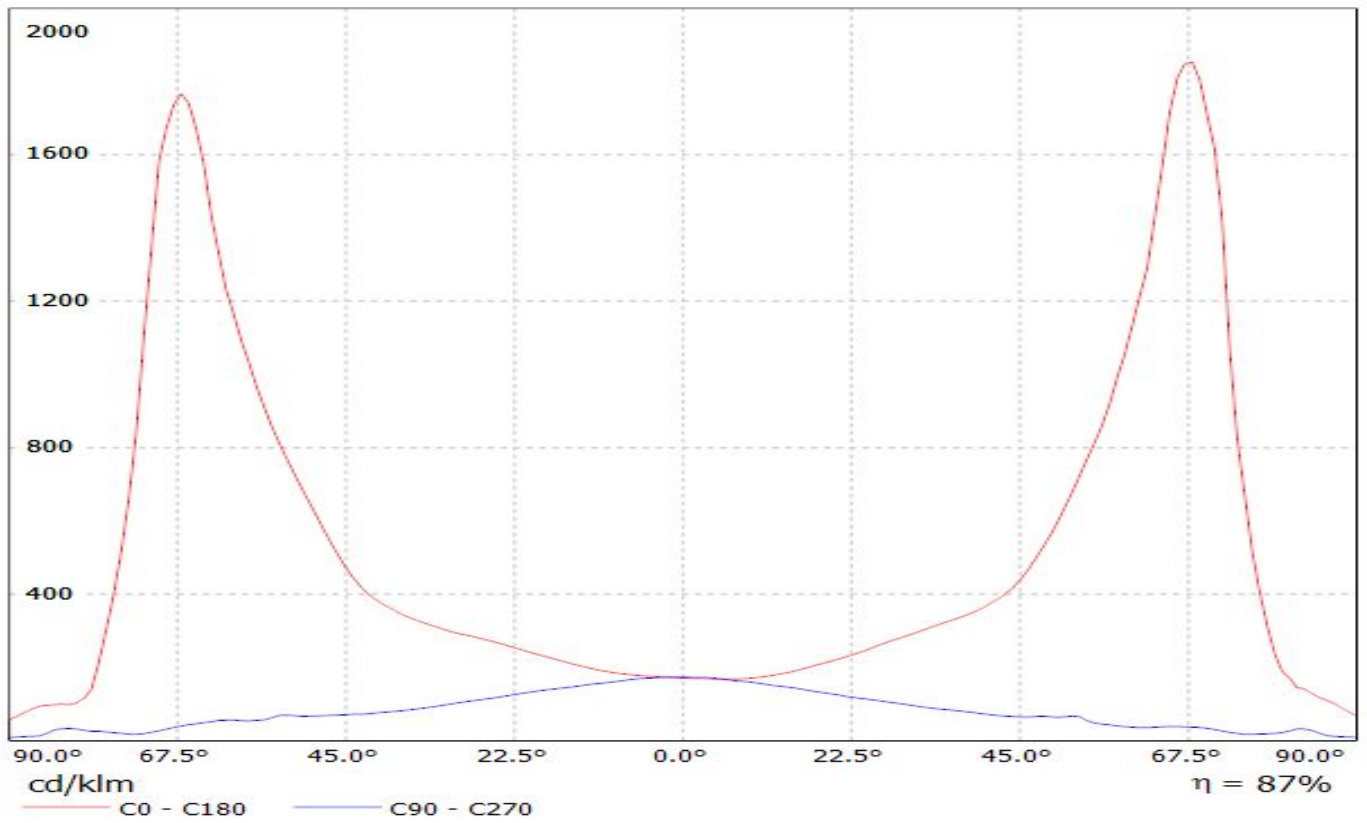

Luminaire: LEDiL Oy CA13156\_EMERALD-A\_(NS9x383) Eff. 89,2%  
Lamps: 1 x Nichia NS9x383 (105lm@250mA)

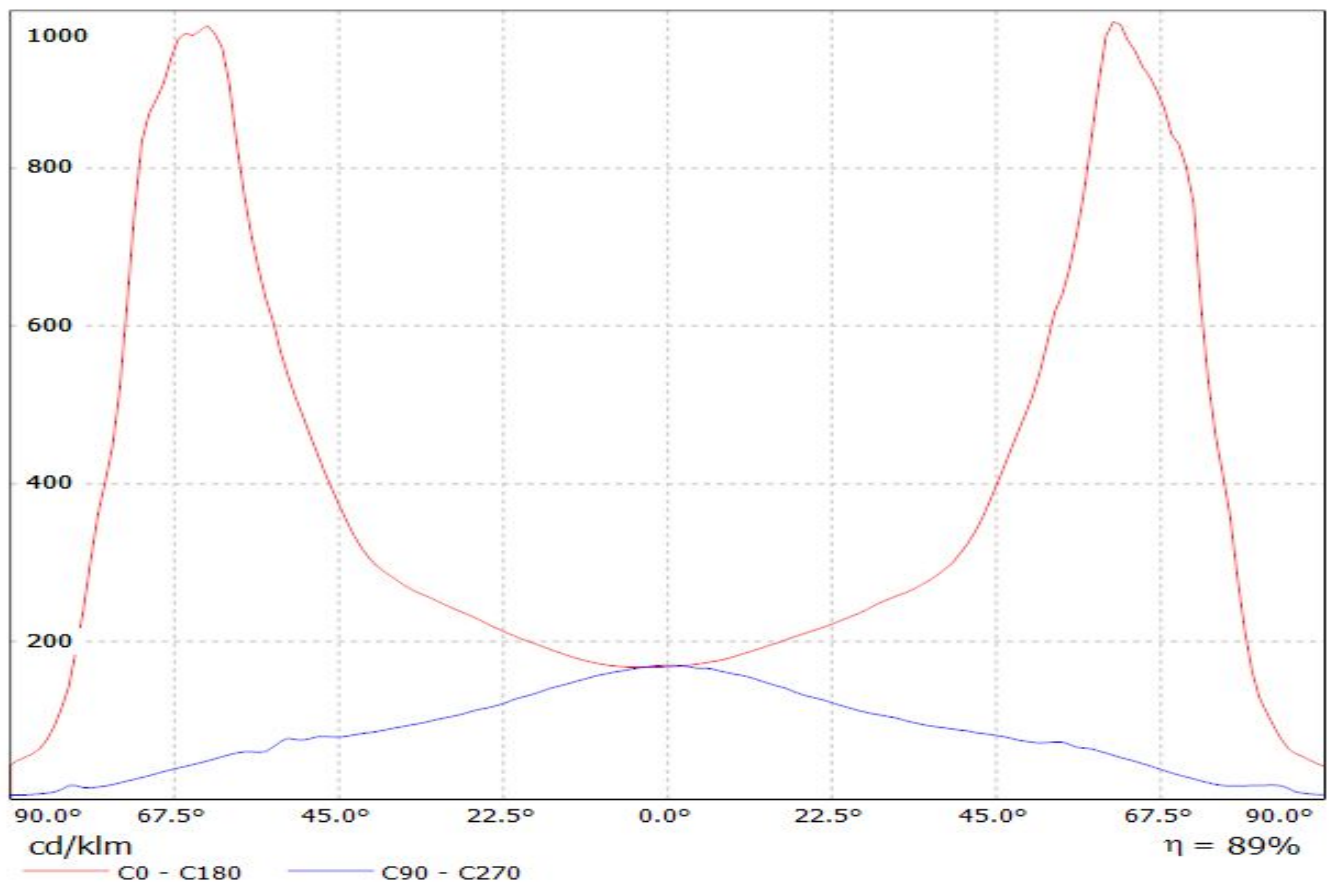

Luminaire: LEDiL Oy CA13156\_EMERALD-A\_(NVSL219CE)  
Lamps: 1 x Nichia\_NVSL219CE\_101.227lm@250mA\_P=0.713404W\_I=0.25A

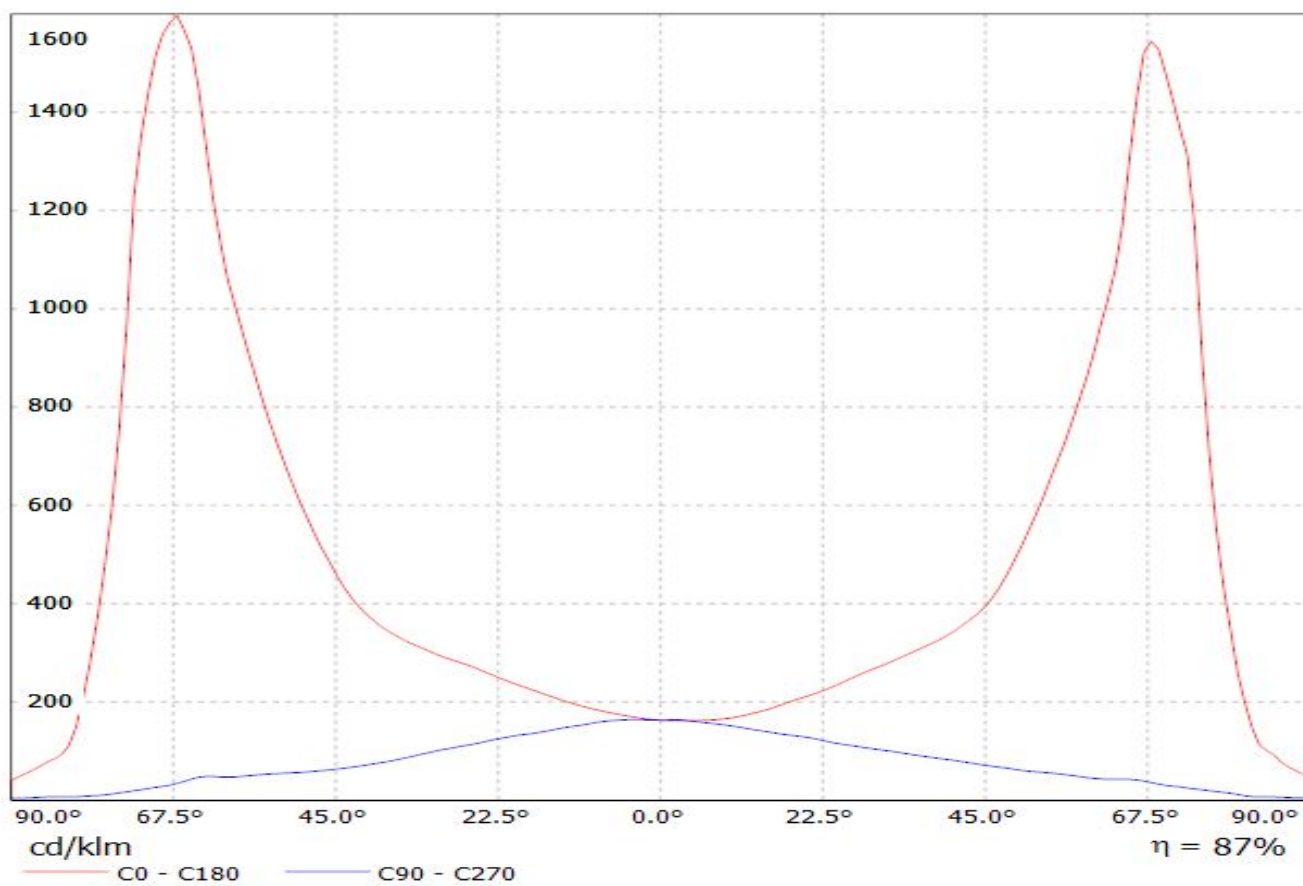

# LEDiL Oy CA13156\_EMERALD-A\_(SQ-EC) Eff.89.6% / LDC (Linear)

Luminaire: LEDiL Oy CA13156\_EMERALD-A\_(SQ-EC) Eff.89.6%  
Lamps: 1 x SQ-EC (64.5908lm@250mA)

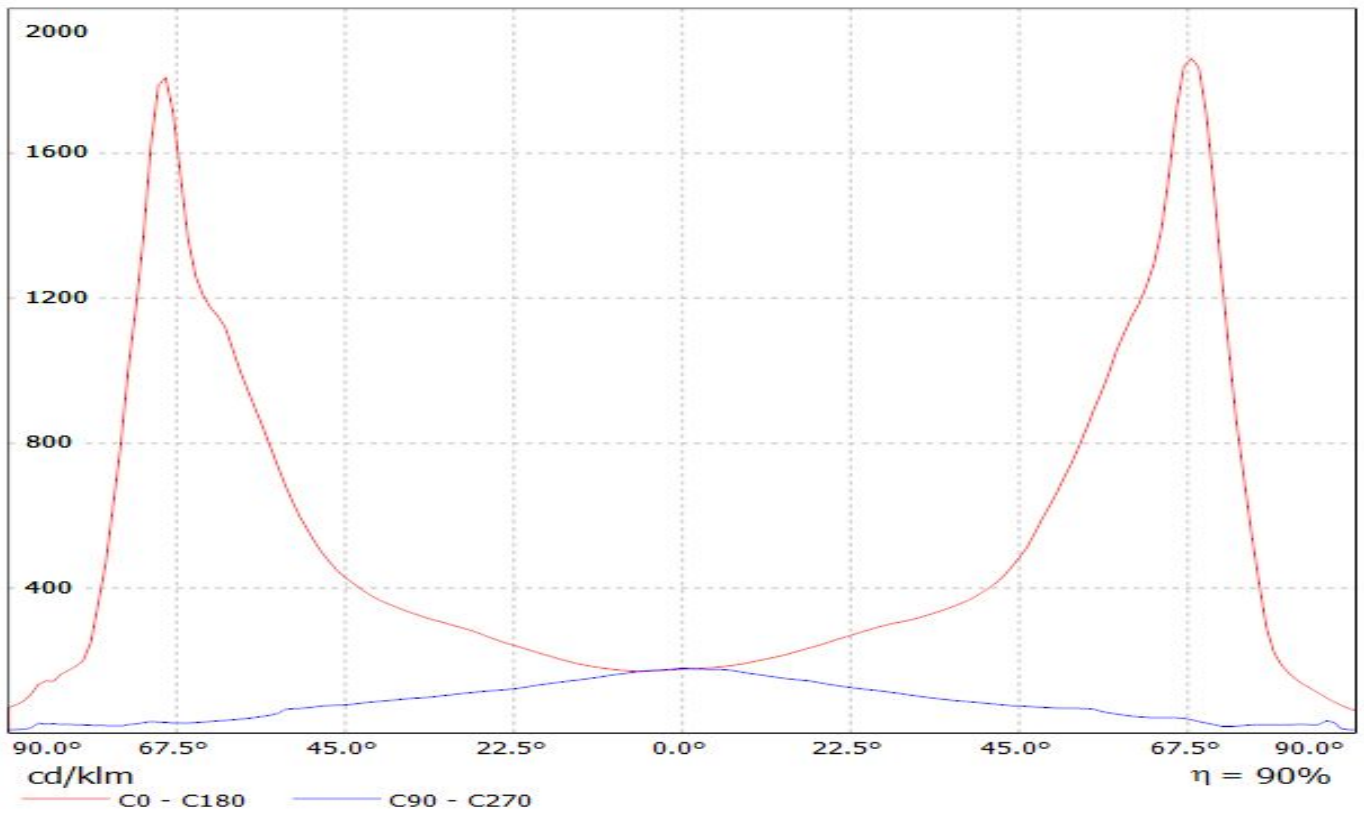



# LEDiL Oy CA13156\_EMERALD-A\_(SQ-PC) Eff.89.1% / LDC (Linear)

Luminaire: LEDiL Oy CA13156\_EMERALD-A\_(SQ-PC) Eff.89.1%  
Lamps: 1 x SQ-PC (79.1971lm@250mA)

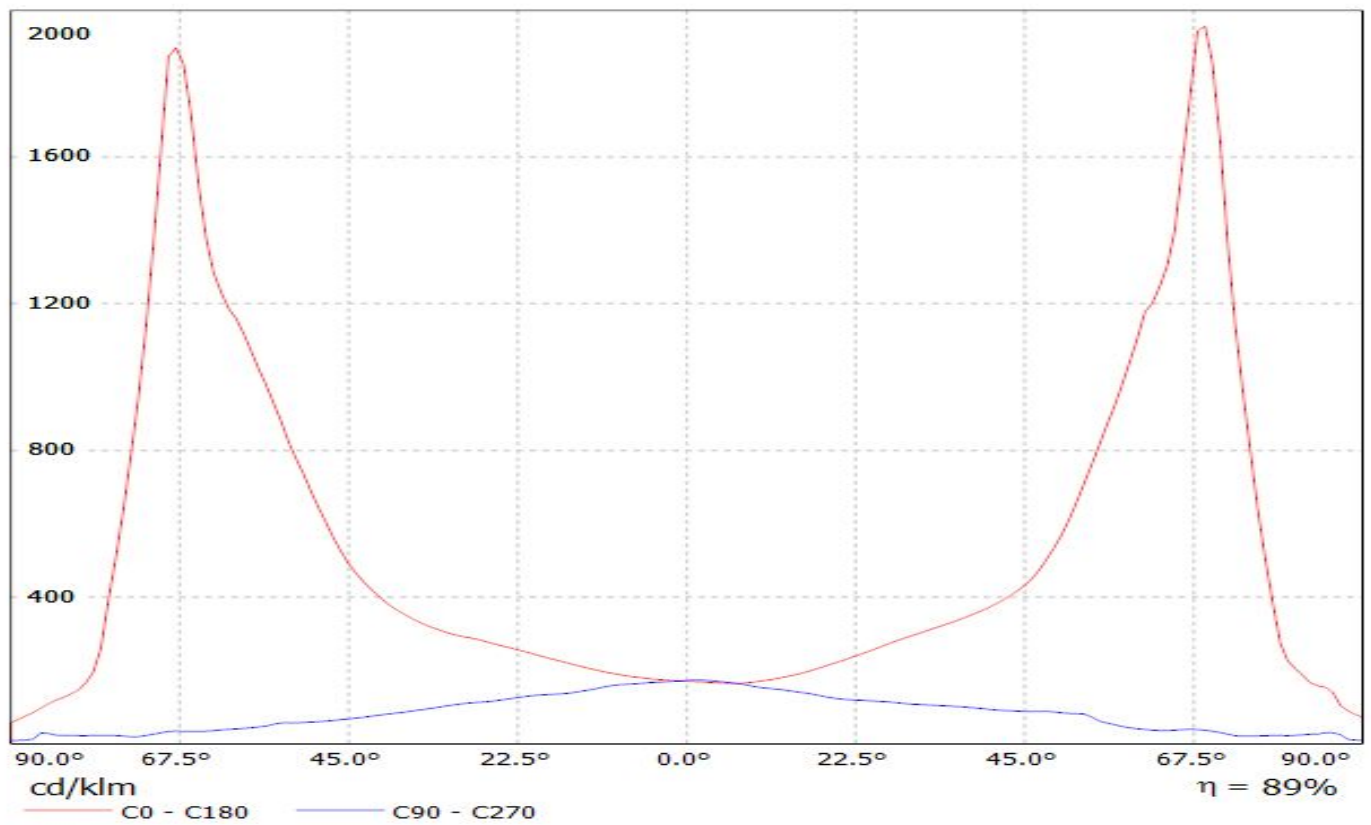

# LEDiL Oy CA13156\_EMERALD-A\_(SSL150) Eff.91.4% / LDC (Linear)

Luminaire: LEDiL Oy CA13156\_EMERALD-A\_(SSL150) Eff.91.4%  
Lamps: 1 x Oslon SSL150 (71.5lm@250mA)

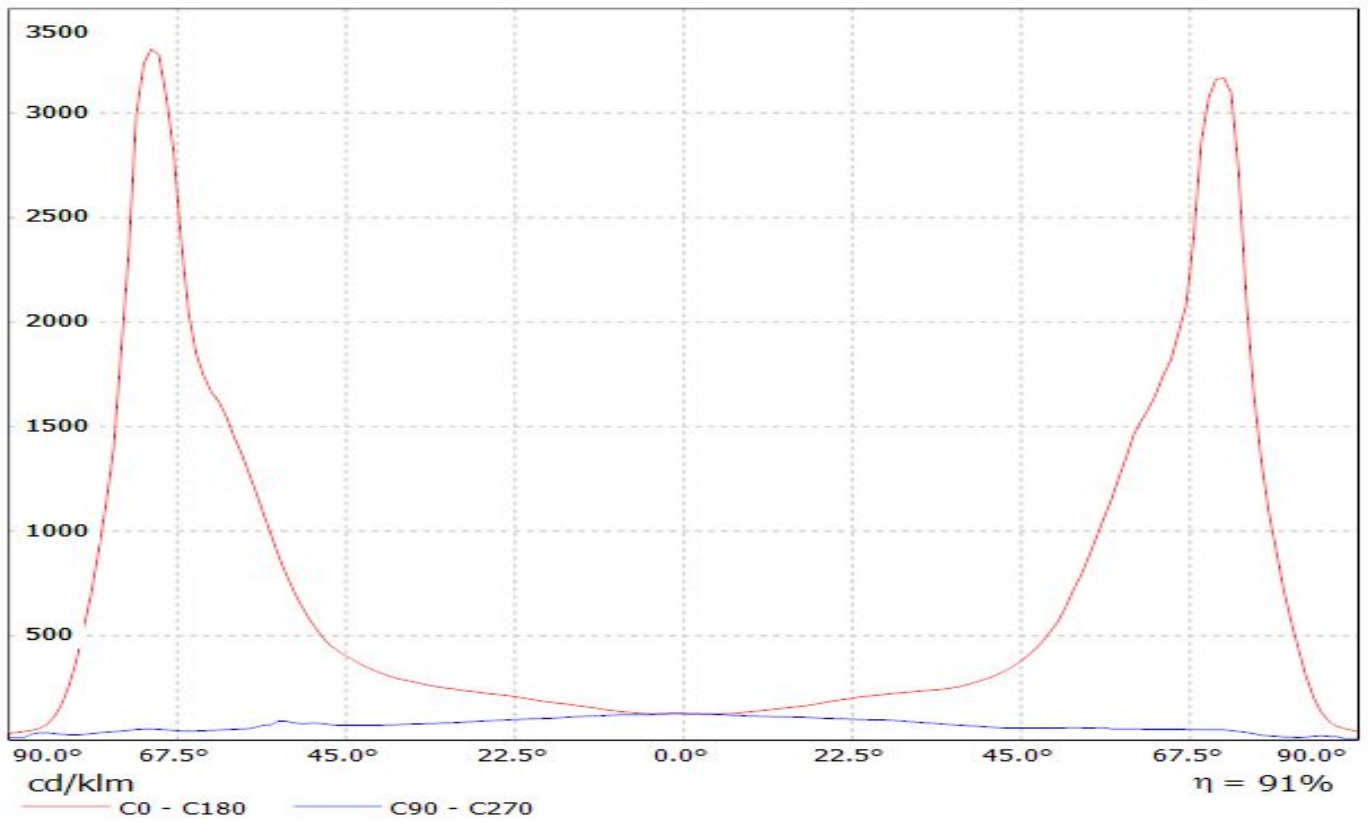

# LEDiL Oy C13155\_EMERALD-A\_(SSL80) Eff.89.4% / LDC (Linear)

Luminaire: LEDiL Oy C13155\_EMERALD-A\_(SSL80) Eff.89.4%  
Lamps: 1 x Oslon SSL (81.3lm@250mA)

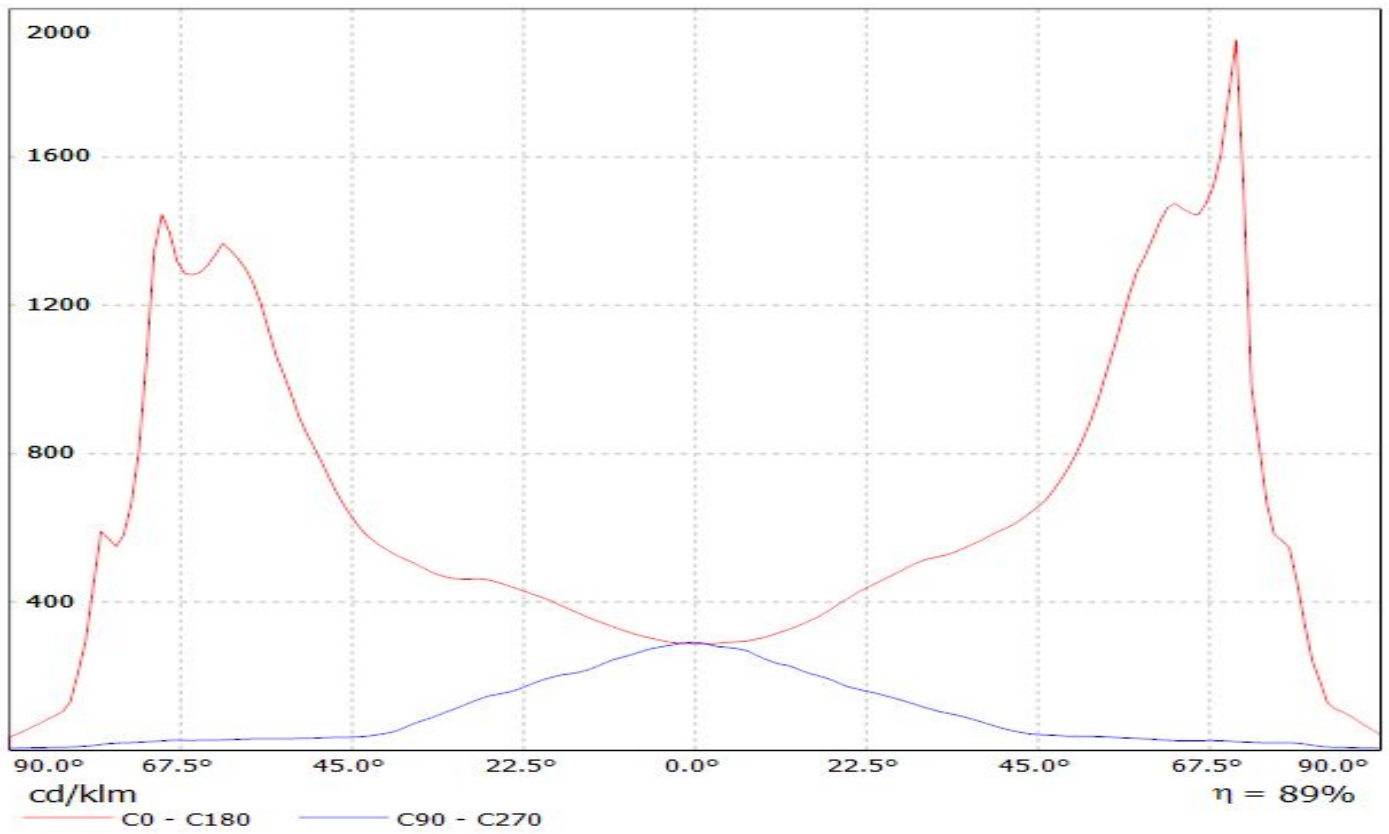

Luminaire: LEDiL Oy CA13156\_EMERALD-A\_(Square\_Giant) Osram\_Square\_Giant\_113.056lm@250mA\_P=0.722\_I=250mA  
Lamps: 1 x Osram\_Square\_Giant\_113.056lm@250mA\_P=0.722\_I=250mA

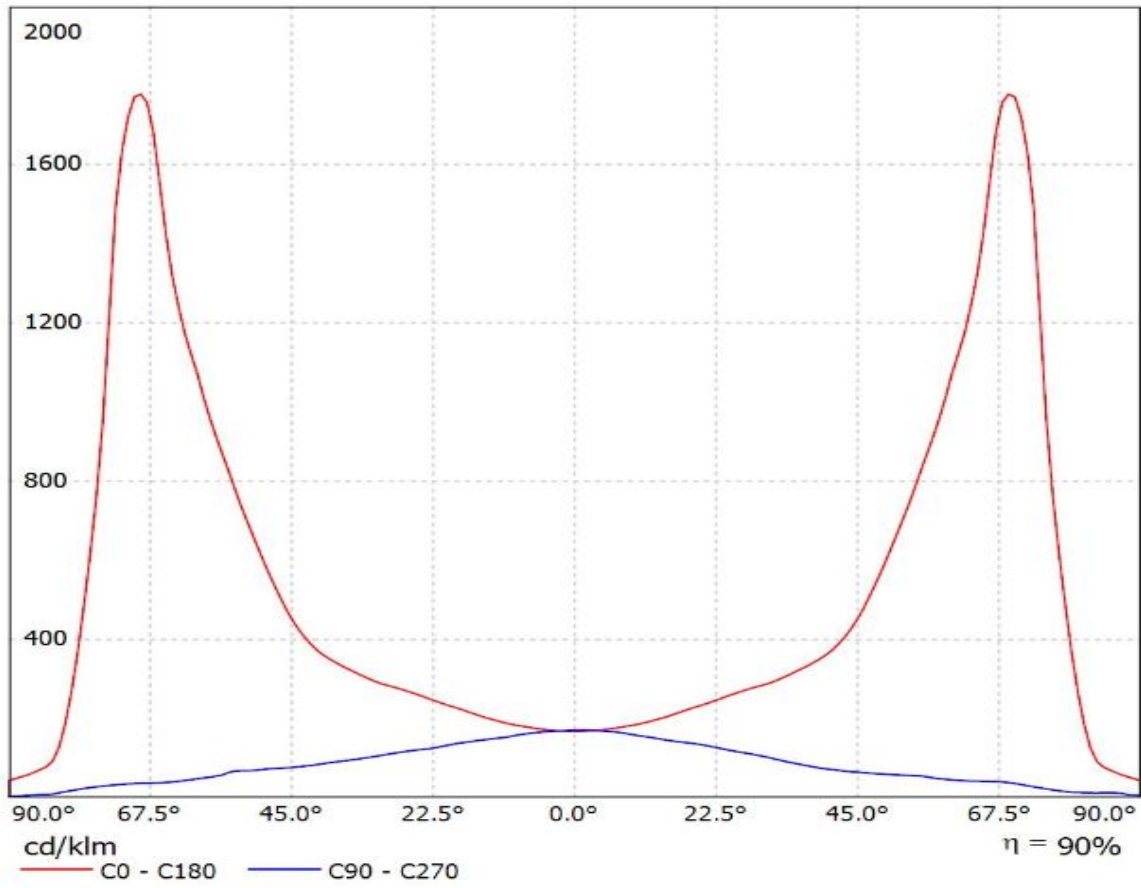

# LEDiL Oy CA13156\_EMERALD-A\_(XP-E) Eff.91.5% / LDC (Polar)

Luminaire: LEDiL Oy CA13156\_EMERALD-A\_(XP-E) Eff.91.5%

Lamps: 1 x CREE XP-E (51.4197lm@250mA)

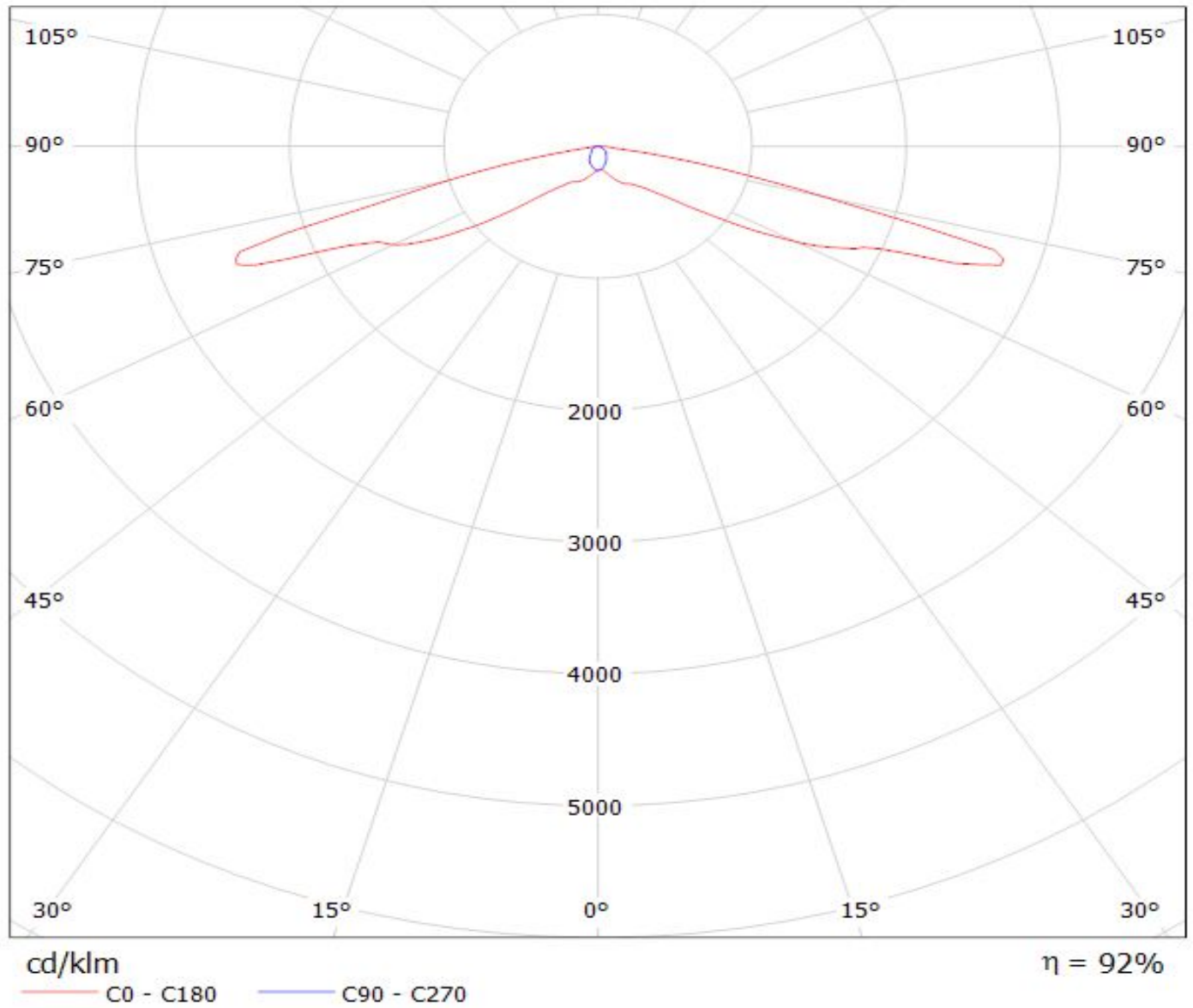

# LEDiL Oy CA13156\_EMERALD-A\_(XB-D) Eff.87.8% / LDC (Polar)

Luminaire: LEDiL Oy CA13156\_EMERALD-A\_(XB-D) Eff.87.8%

Lamps: 1 x Cree XB-D (95lm@250mA)

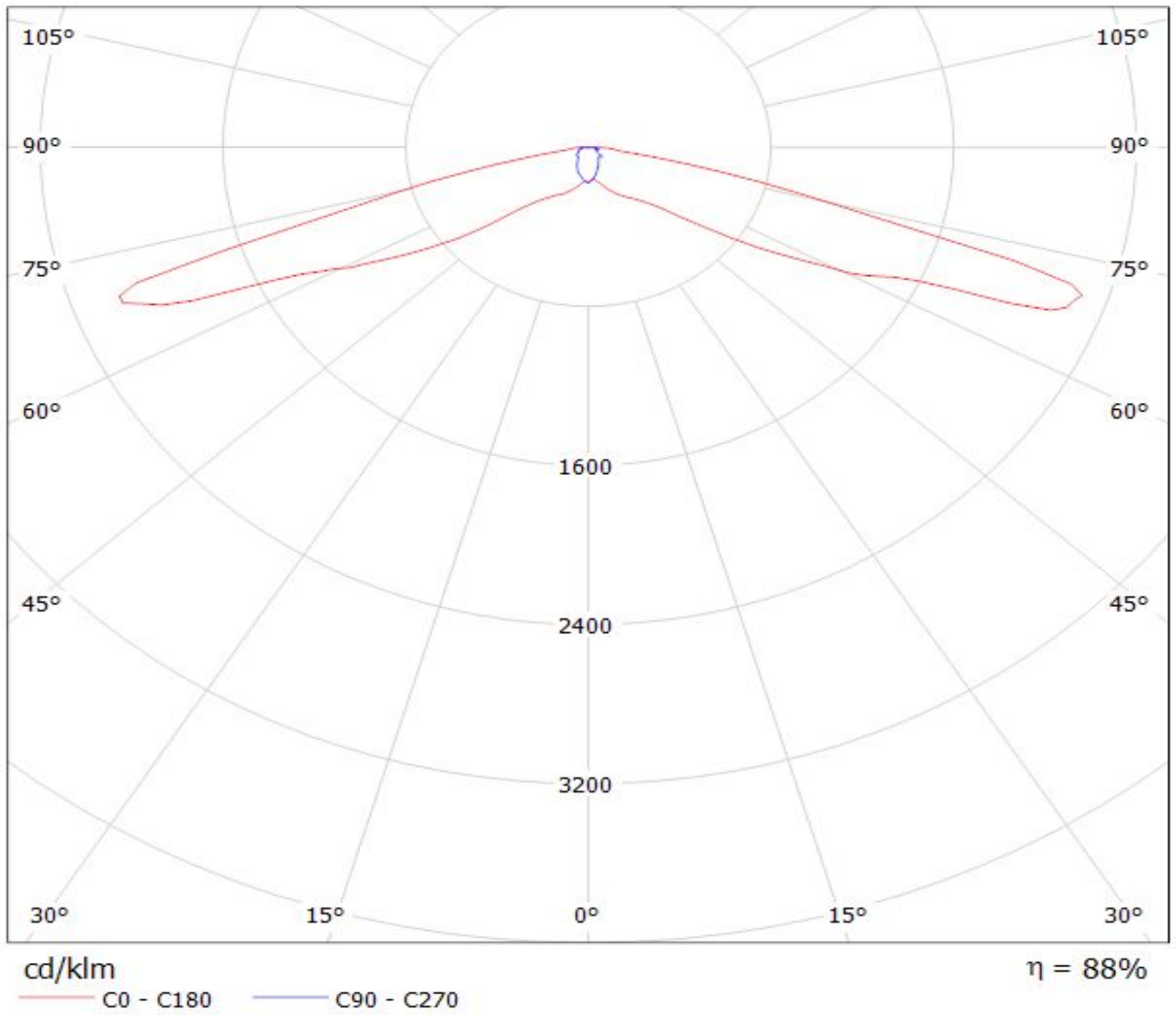

# LEDiL Oy CA13156\_EMERALD-A\_(XM-L) Eff.90.8% / LDC (Polar)

Luminaire: LEDiL Oy CA13156\_EMERALD-A\_(XM-L) Eff.90.8%

Lamps: 1 x Cree XM-L (91.7822lm@250mA)

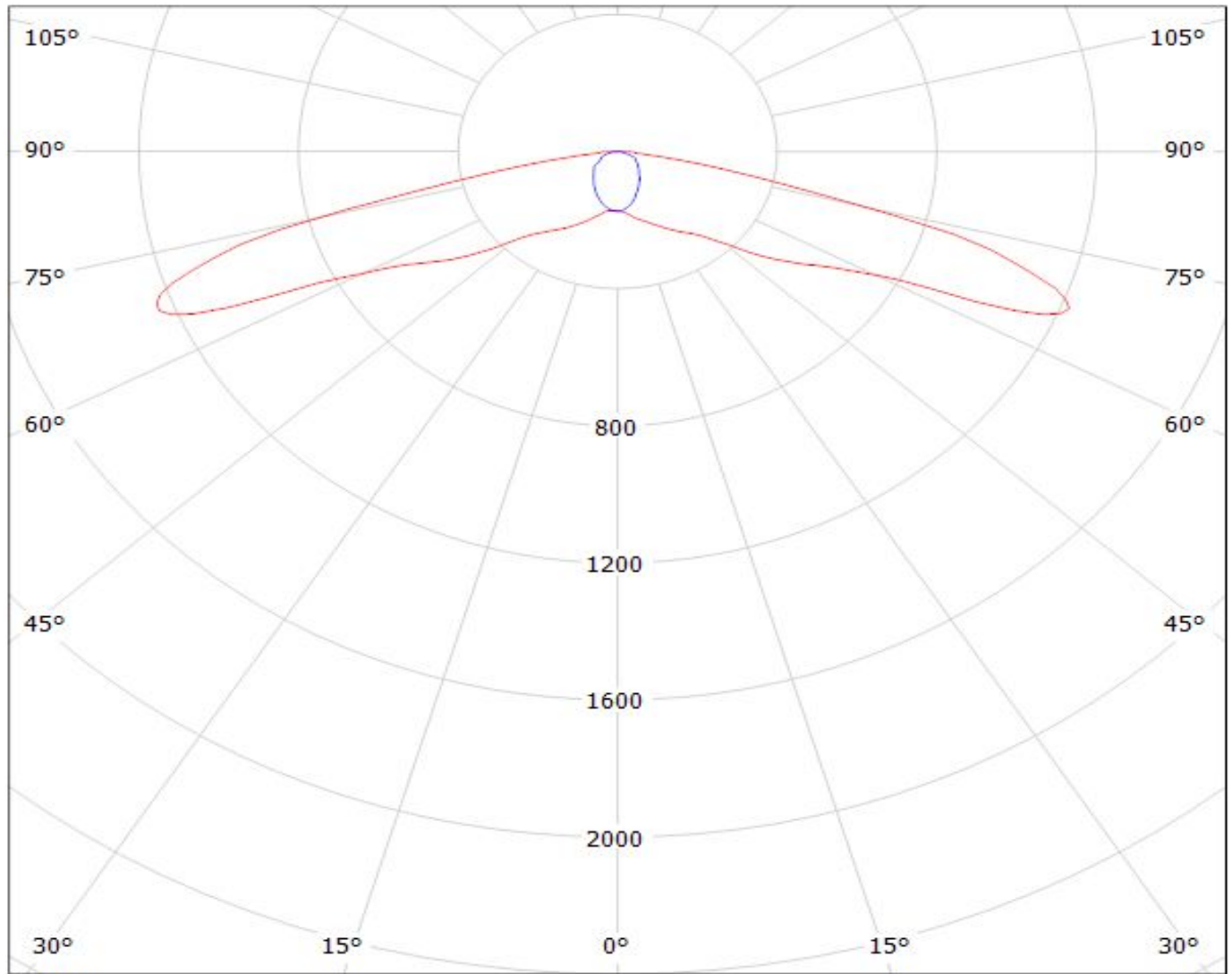

cd/klm

— C0 - C180

— C90 - C270

$\eta = 91\%$



# LEDiL Oy CA13156\_EMERALD-A\_(XP-G) Eff.88.1% / LDC (Polar)

Luminaire: LEDiL Oy CA13156\_EMERALD-A\_(XP-G) Eff.88.1%

Lamps: 1 x XP-G (70.6lm@250mA)

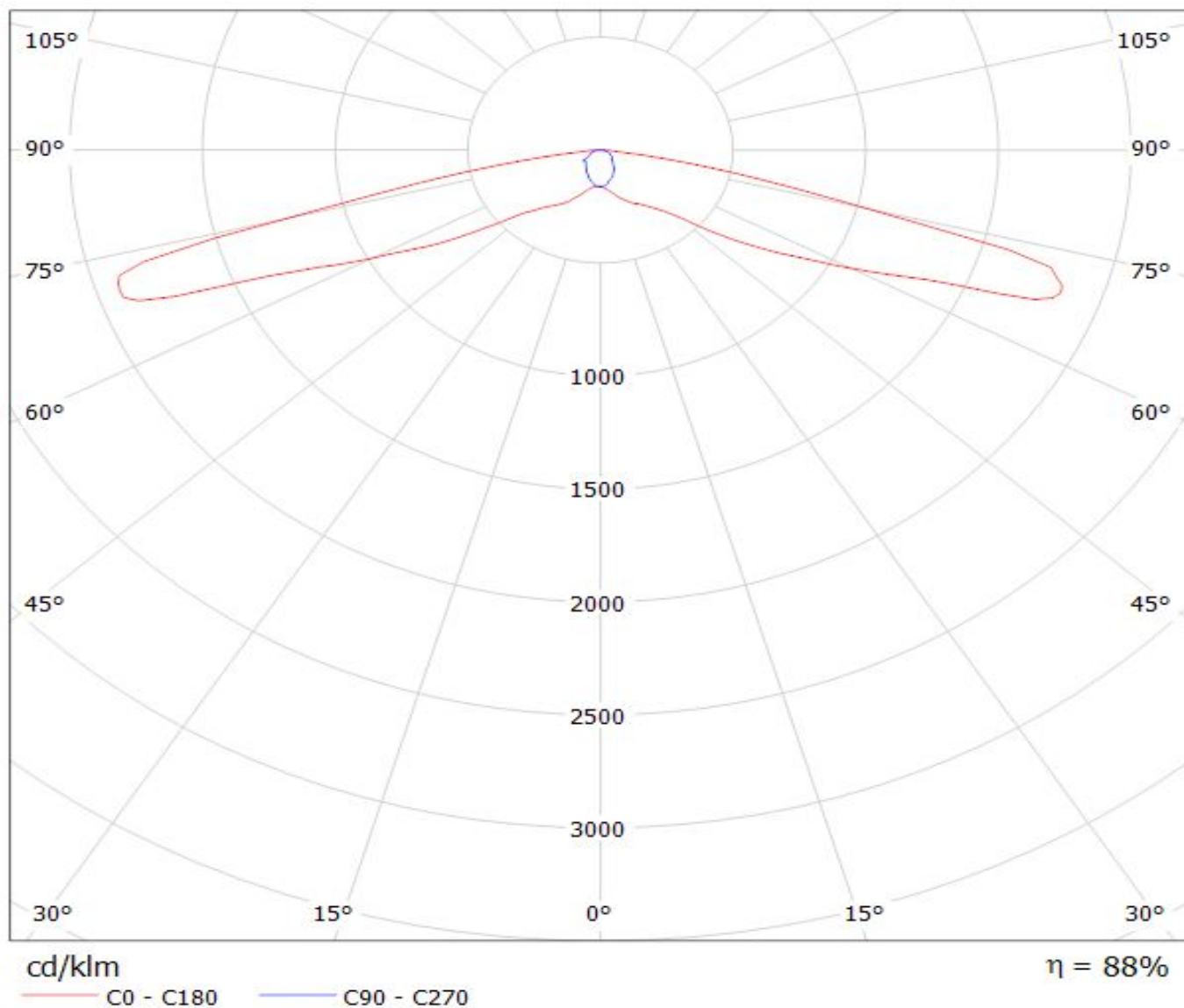



# LEDiL Oy CA13156\_EMERALD-A\_(XT-E) Eff.88.2% / LDC (Polar)

Luminaire: LEDiL Oy CA13156\_EMERALD-A\_(XT-E) Eff.88.2%

Lamps: 1 x Cree XT-E (102.3lm@250mA)

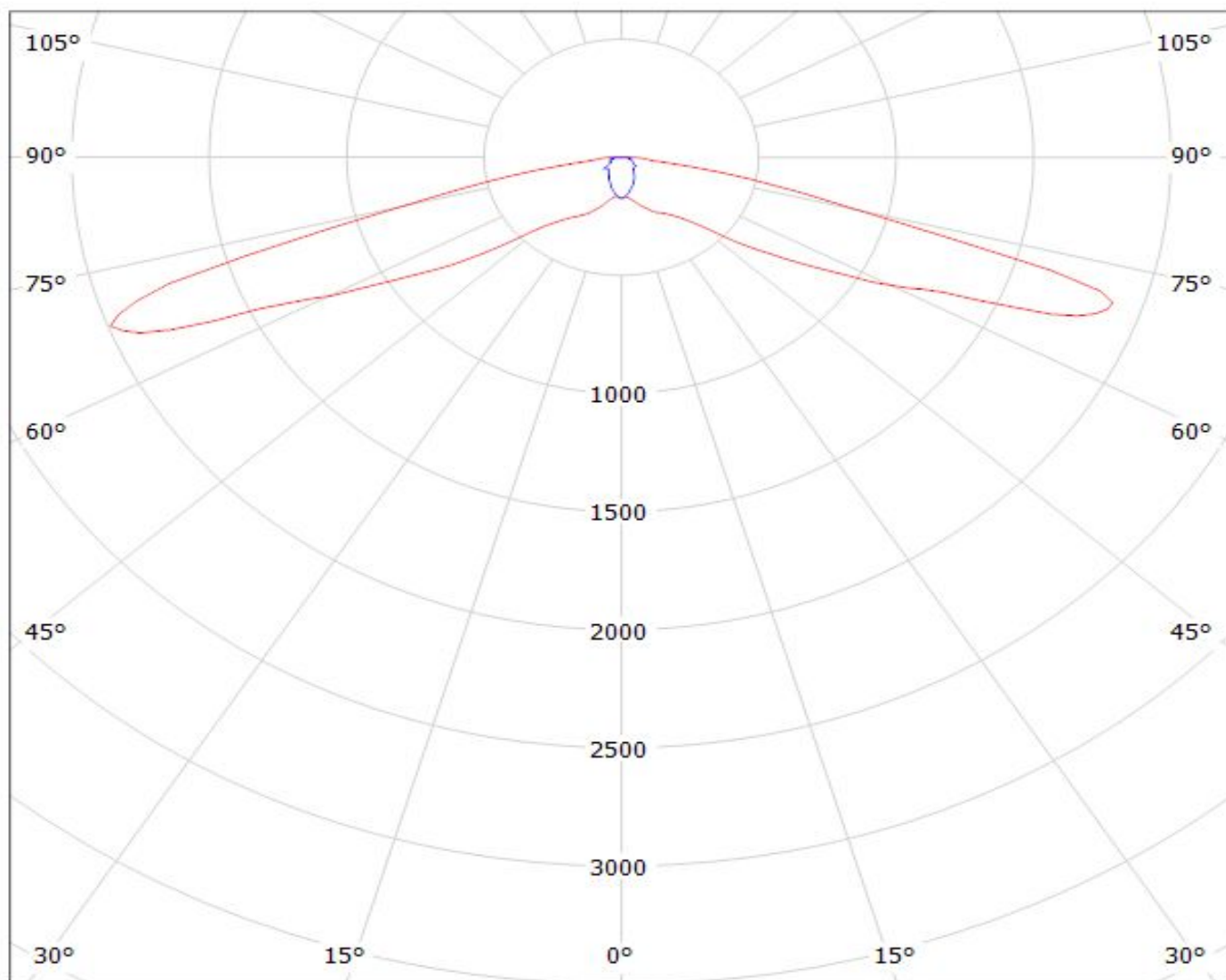

cd/klm

$\eta = 88\%$

— C0 - C180    — C90 - C270

# LEDiL Oy CA13156\_EMERALD-A\_(XP-E2) Eff.91.7% / LDC (Polar)

Luminaire: LEDiL Oy CA13156\_EMERALD-A\_(XP-E2) Eff.91.7%

Lamps: 1 x CREE XP-E2 (93.5lm@250mA)

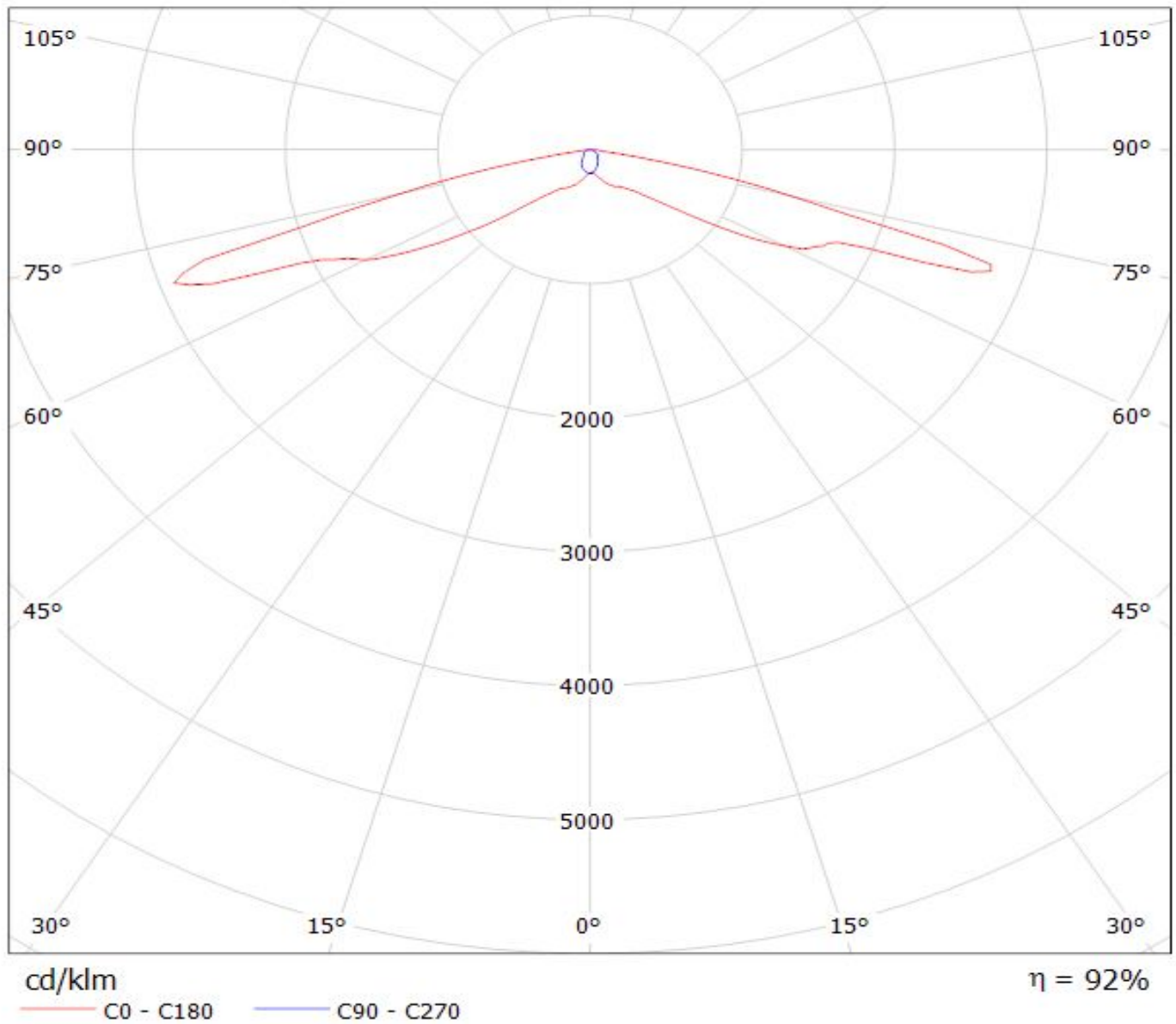

Luminaire: LEDil Oy CA13156 EMERALD-A\_(XM-L2) Efficiency=92%  
Lamps: 1 x Cree XM-L2 (XMLBWT-0-7B4-T30-0L-0001) 91lm @ 250mA CCT=3200K P=0.7W I=250mA

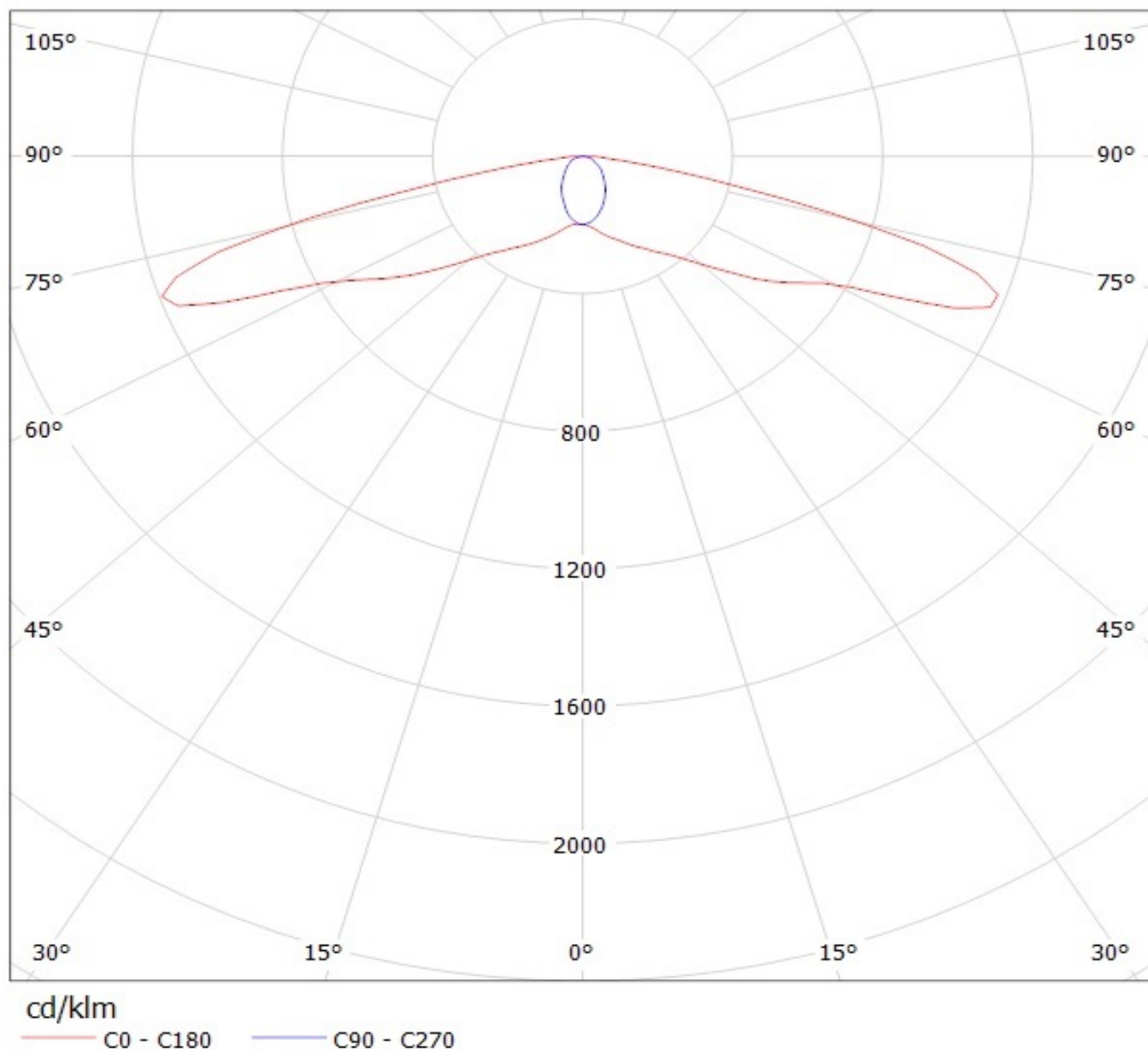

# LEDiL Oy CA13156\_EMERALD-A\_(XP-G2) Eff.91.4% / LDC (Polar)

Luminaire: LEDiL Oy CA13156\_EMERALD-A\_(XP-G2) Eff.91.4%

Lamps: 1 x CREE XP-G2 (105.7lm@250mA)

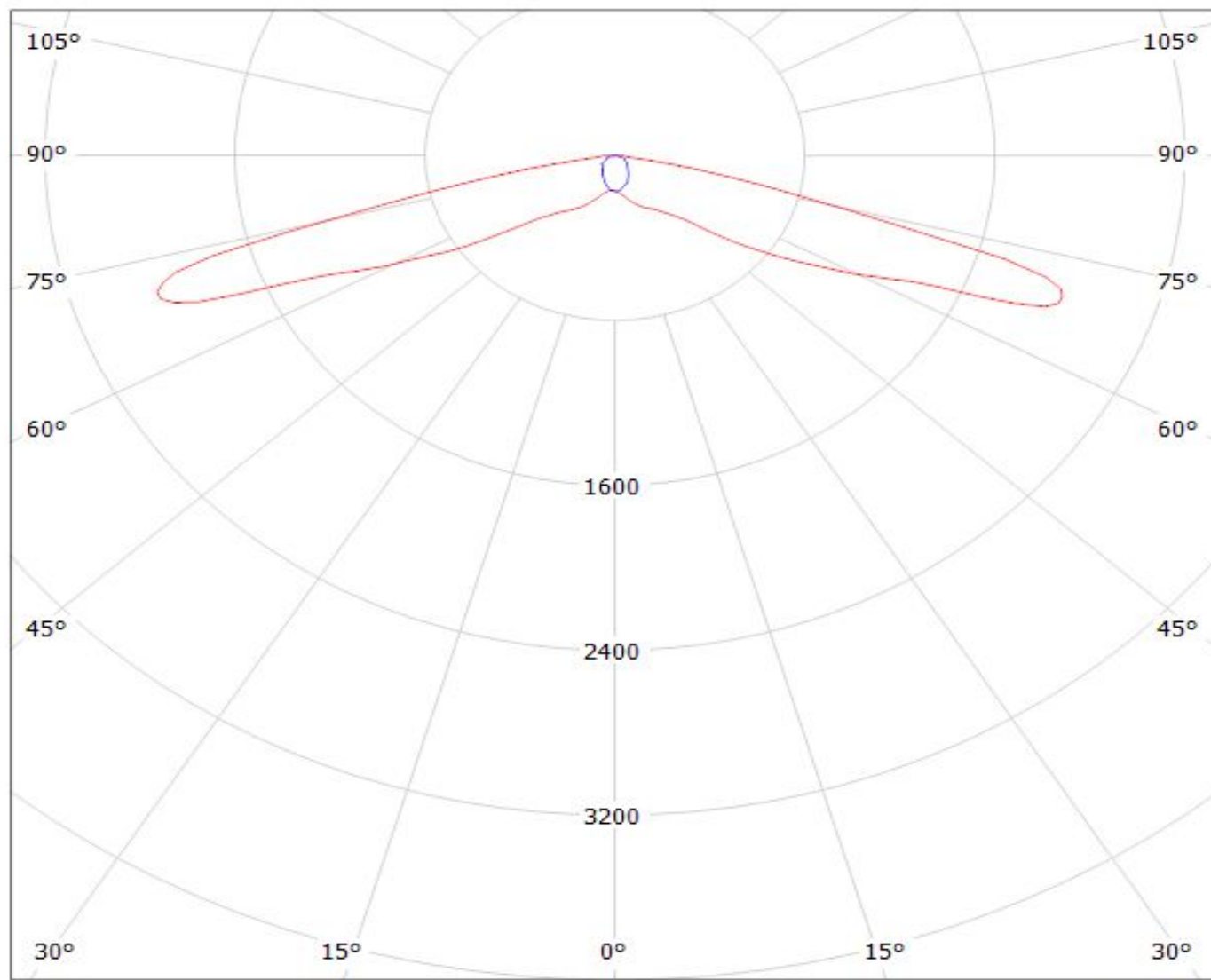

cd/klm

— C0 - C180

— C90 - C270

$\eta = 91\%$

# LEDiL Oy CA13156\_EMERALD-A\_(LG3535) Eff.89.7% / LDC (Polar)

Luminaire: LEDiL Oy CA13156\_EMERALD-A\_(LG3535) Eff.89.7%  
Lamps: 1 x LG 3535 Ceramic (94lm@250mA)

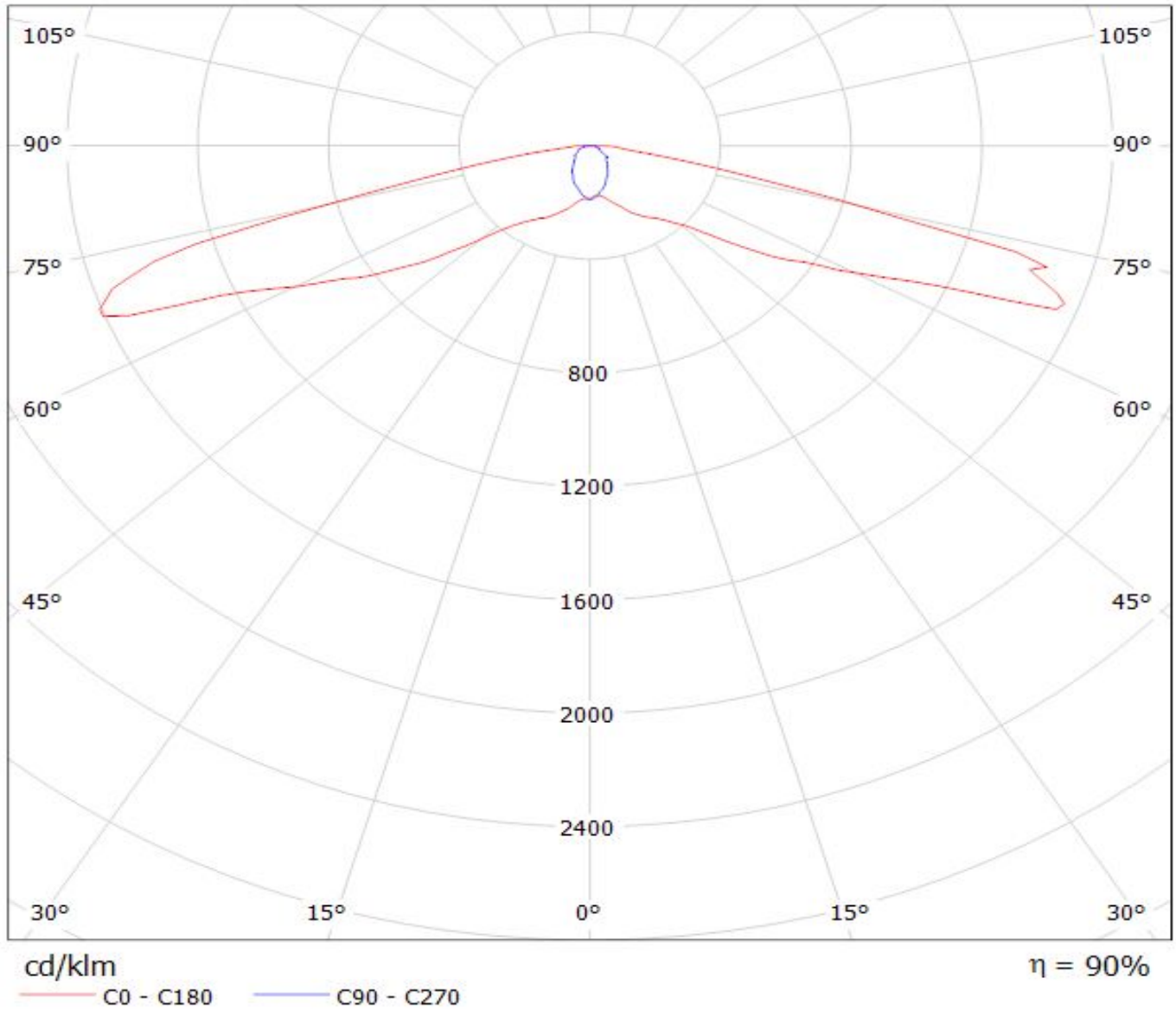

# LEDiL Oy CA13156\_EMERALD-A\_(LG3535\_2W) Eff.92.6% / LDC (Polar)

Luminaire: LEDiL Oy CA13156\_EMERALD-A\_(LG3535\_2W) Eff.92.6%  
Lamps: 1 x LG3535\_2W (97.3629lm@250mA)

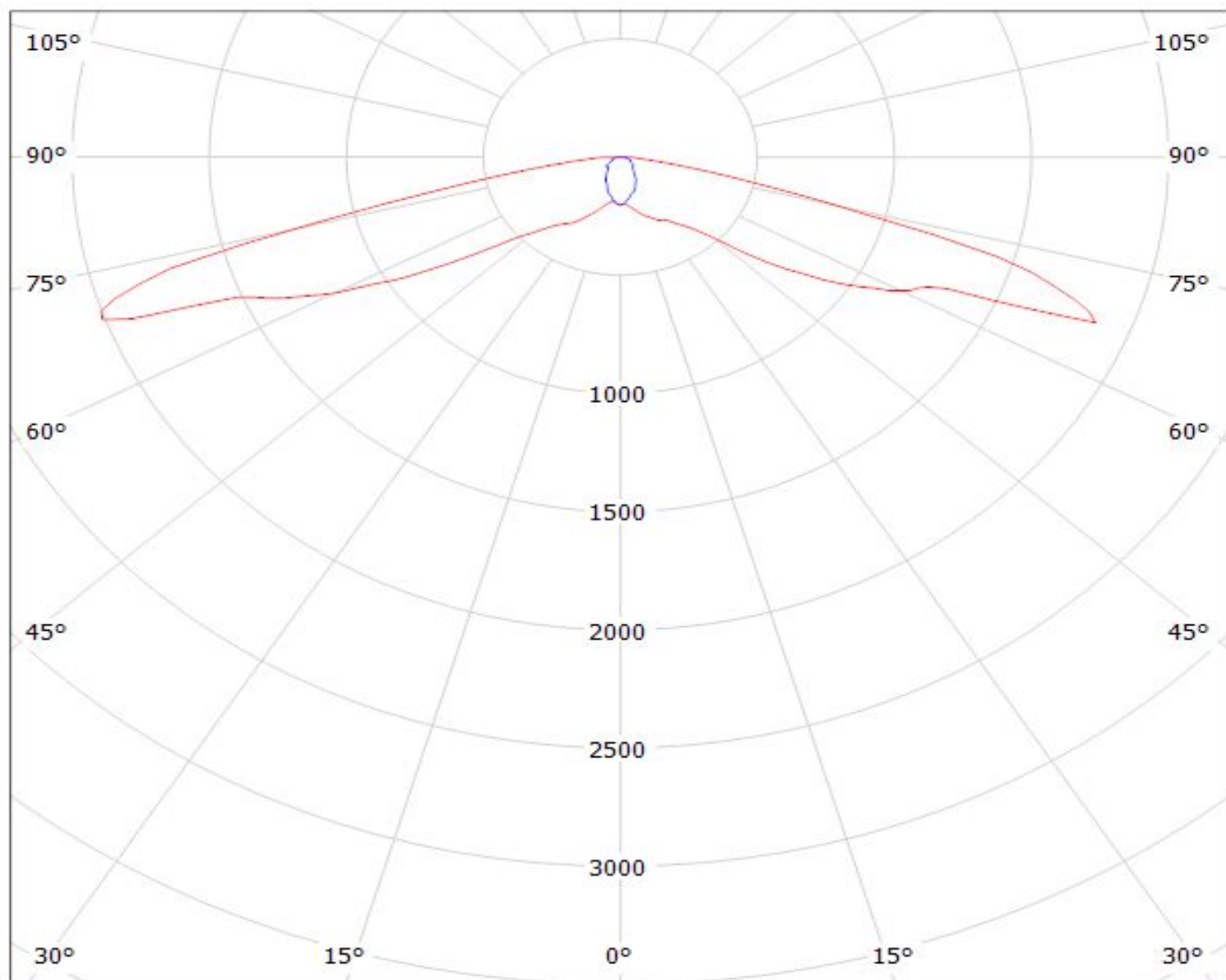

cd/klm

— C0 - C180

— C90 - C270

$\eta = 93\%$



# LEDiL Oy CA13156\_EMERALD-A\_(LUXEON\_A) Eff.88.6% / LDC (Polar)

Luminaire: LEDiL Oy CA13156\_EMERALD-A\_(LUXEON\_A) Eff.88.6%

Lamps: 1 x LUXEON\_R (67.5lm@250mA)

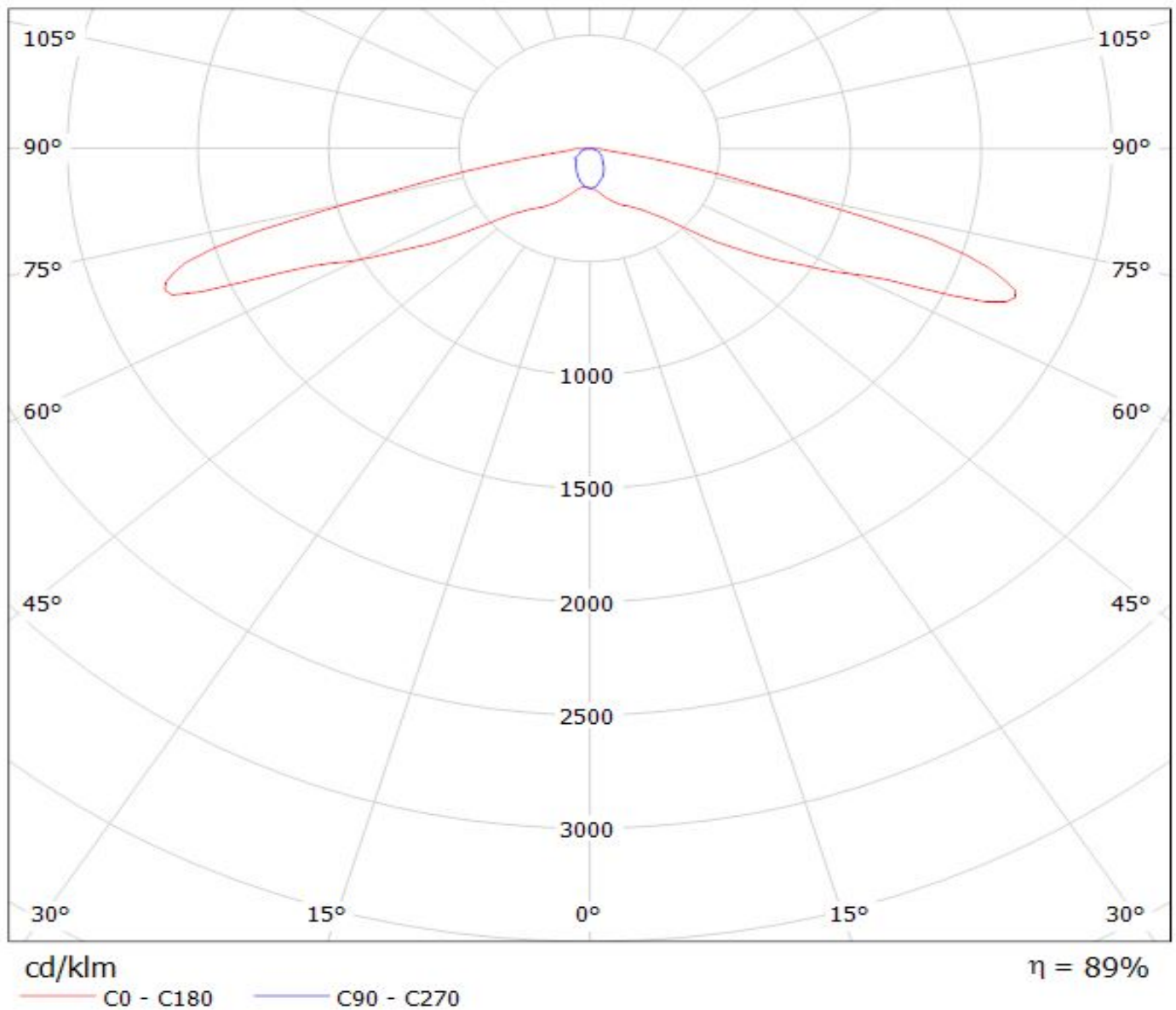

Luminaire: LEDiL Oy CA13156\_EMERALD-A\_(Rebel) Eff. 88,8%

Lamps: 1 x Luxeon Rebel (82lm@250mA)

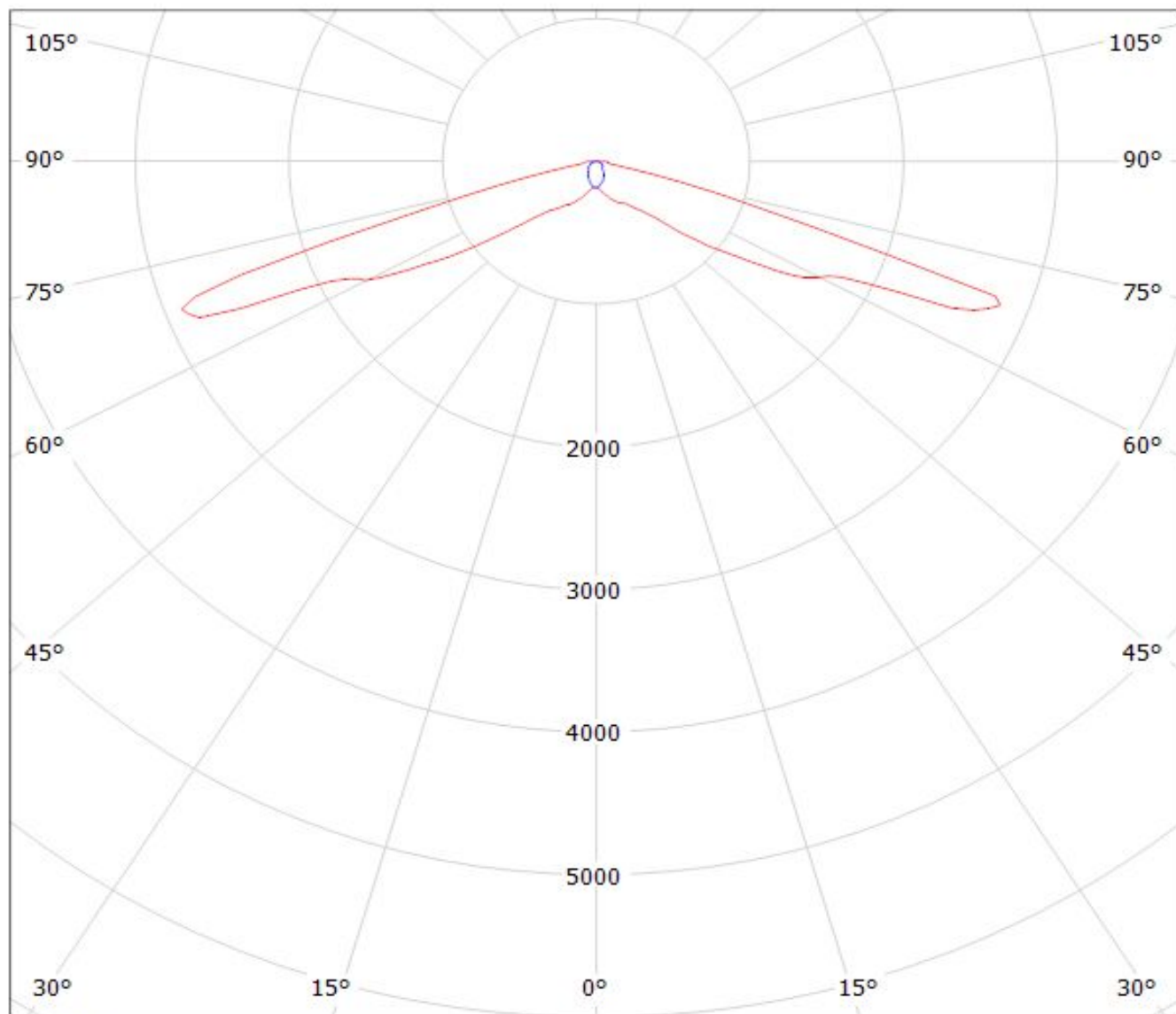

cd/klm

$\eta = 89\%$

— C0 - C180    — C90 - C270



# LEDiL Oy CA13156\_EMERALD-A\_(LUXEON\_R) Eff.88.4% / LDC (Polar)

Luminaire: LEDiL Oy CA13156\_EMERALD-A\_(LUXEON\_R) Eff.88.4%

Lamps: 1 x LUXEON\_R (85.6lm@250mA)

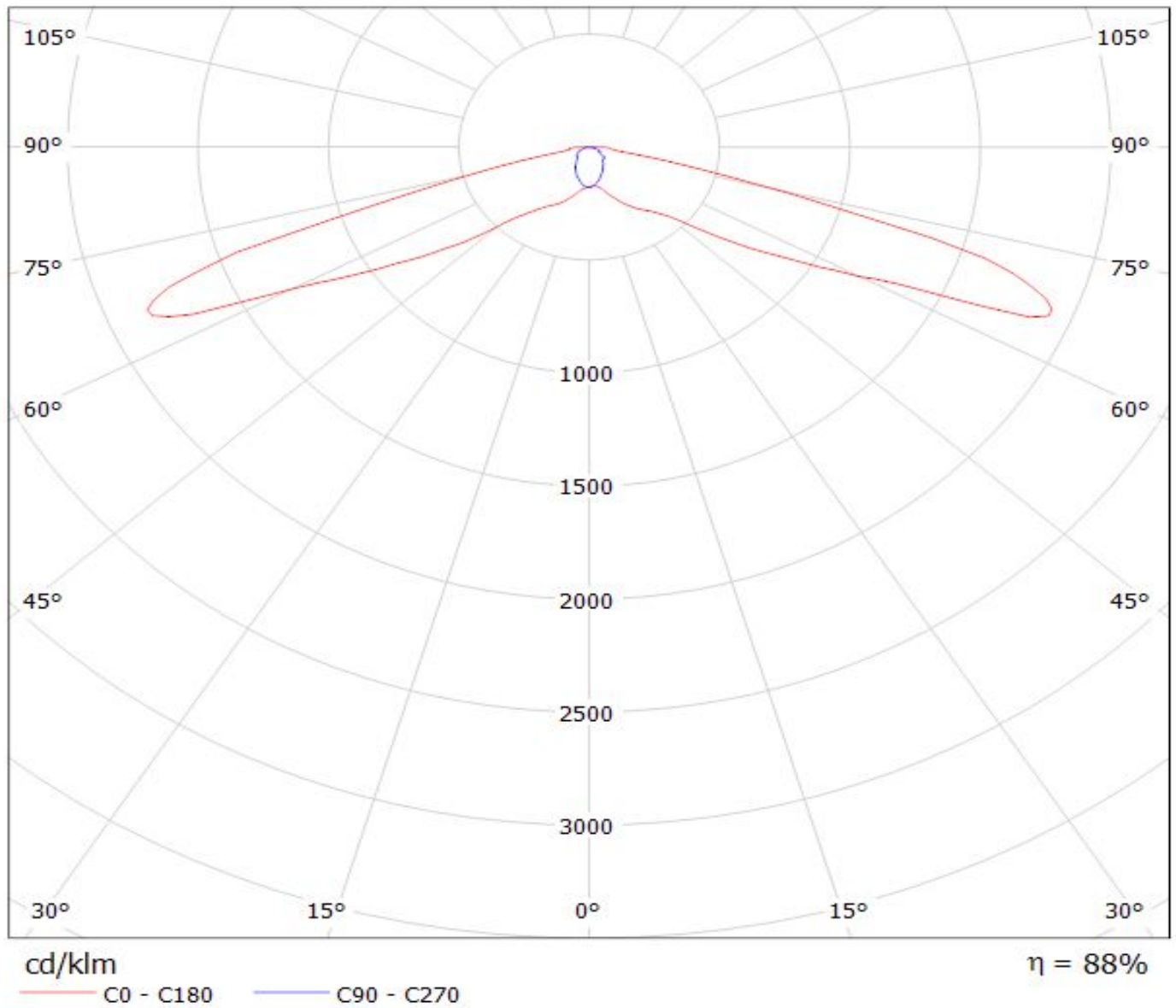

Luminaire: LEDiL Oy CA13156\_EMERALD-A\_(Rebel-ES) Eff. 88%

Lamps: 1 x Luxeon Rebel-ES (90lm@250mA)

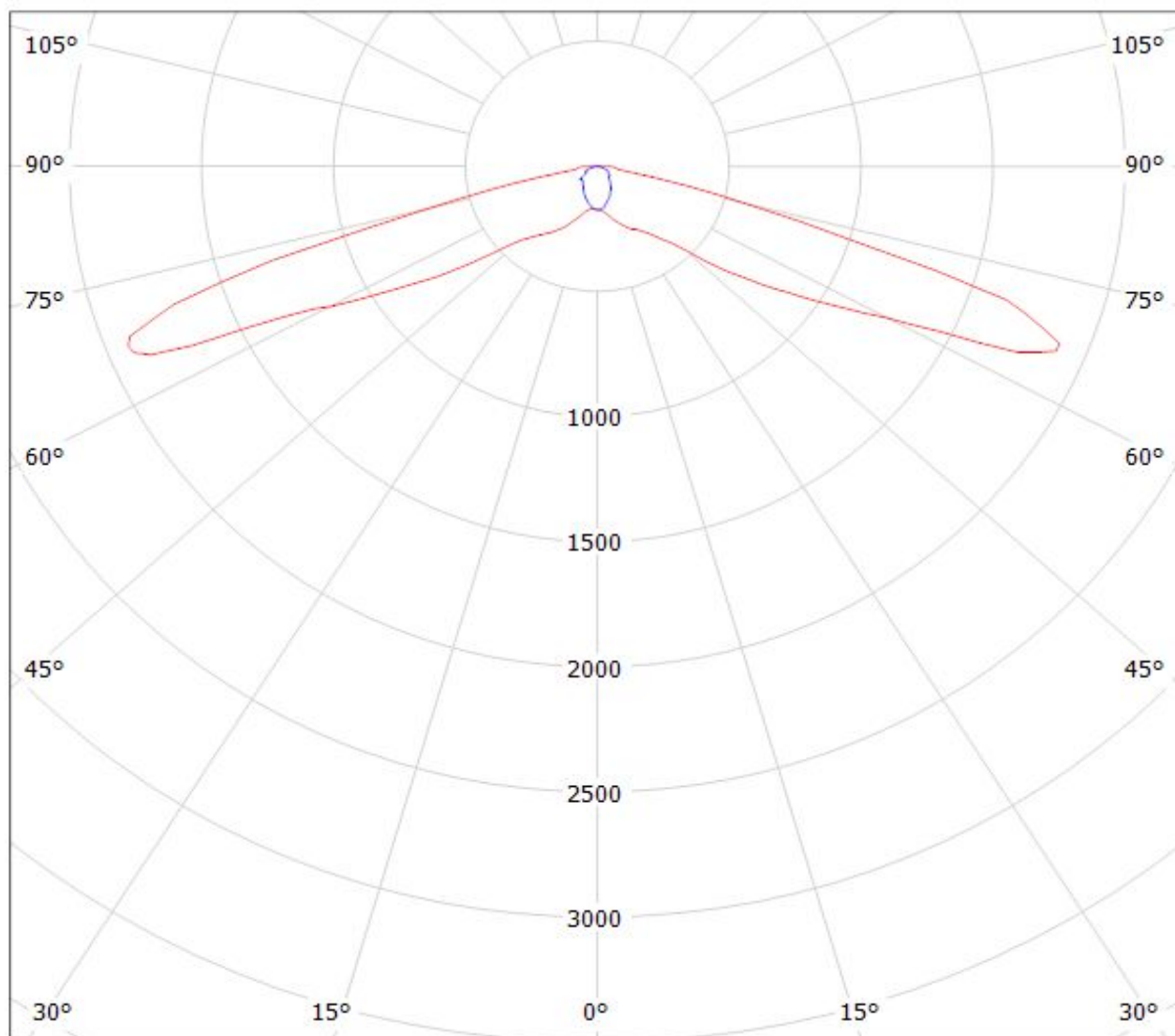

cd/klm

— C0 - C180

— C90 - C270

$\eta = 88\%$

Luminaire: Ledil Oy CA13156\_EMERALD-A (Luxeon T 71lm @ 250mA) Efficiency=93%  
Lamps: 1 x Luxeon T 71lm @ 250mA

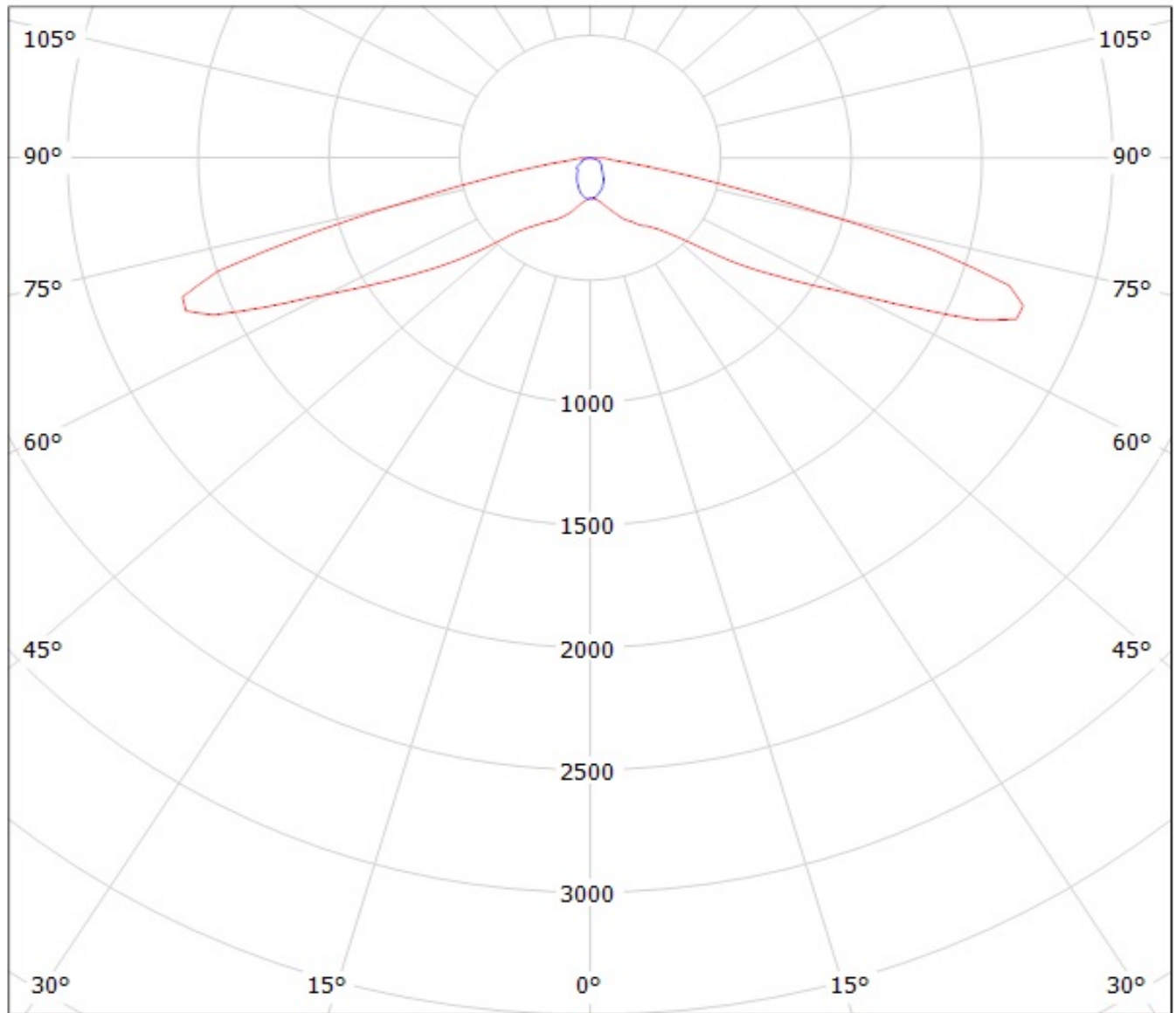

cd/klm

— C0 - C180

— C90 - C270

Luminaire: LEDiL Oy CA13156\_EMERALD-A\_(Luxeon\_TX) Eff.91.7%

Lamps: 1 x Luxeon\_TX\_(L1T2-3585)\_80.1801lm@250mA\_CCT=3500K\_P=0.731482W\_I=249.9mA

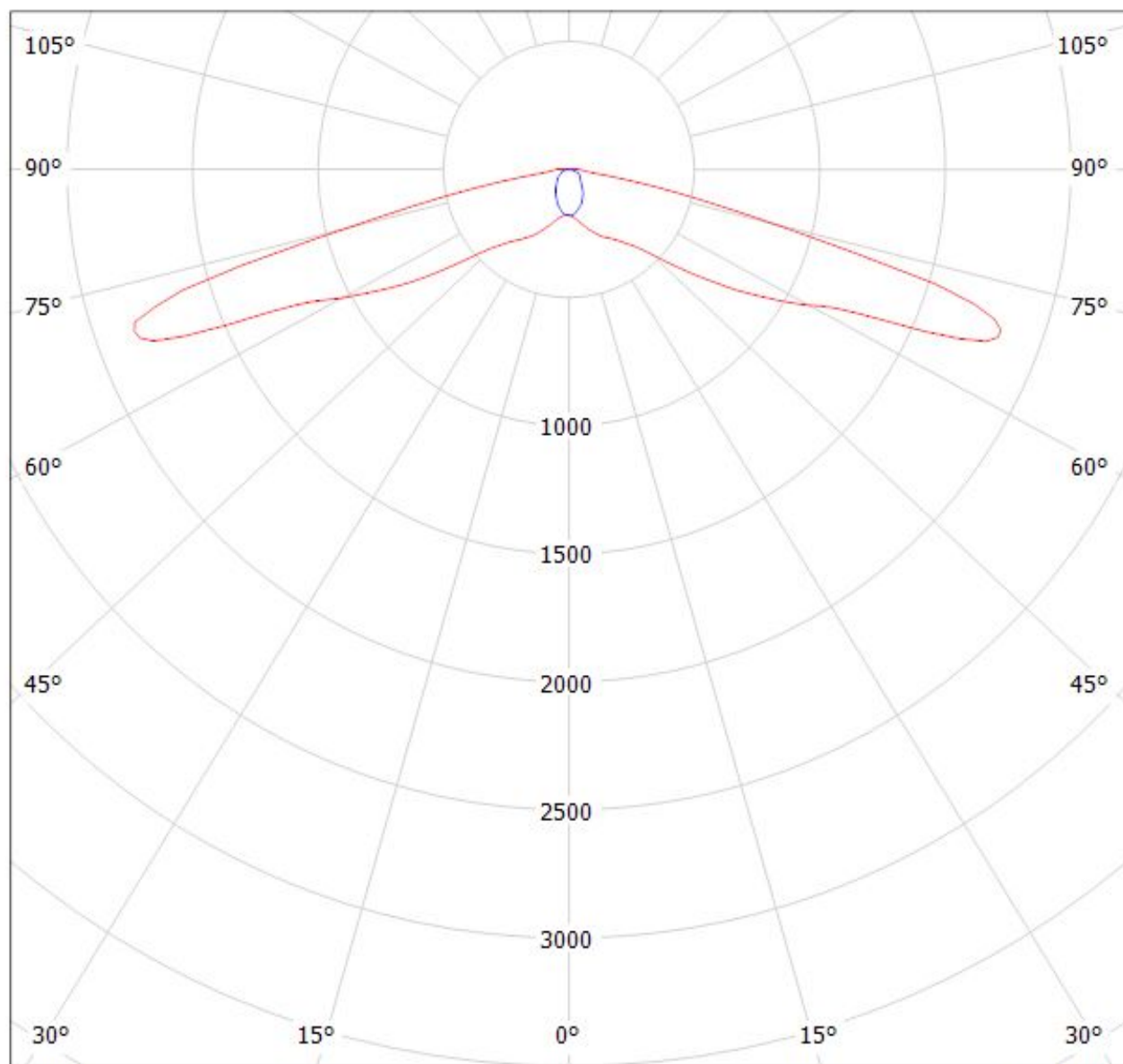

cd/klm

— C0 - C180

— C90 - C270

$\eta = 92\%$

# LEDiL Oy CA13156\_EMERALD-A\_(NCS19) Eff.88.1% / LDC (Polar)

Luminaire: LEDiL Oy CA13156\_EMERALD-A\_(NCS19) Eff.88.1%  
Lamps: 1 x NCS19 (89lm@250mA)

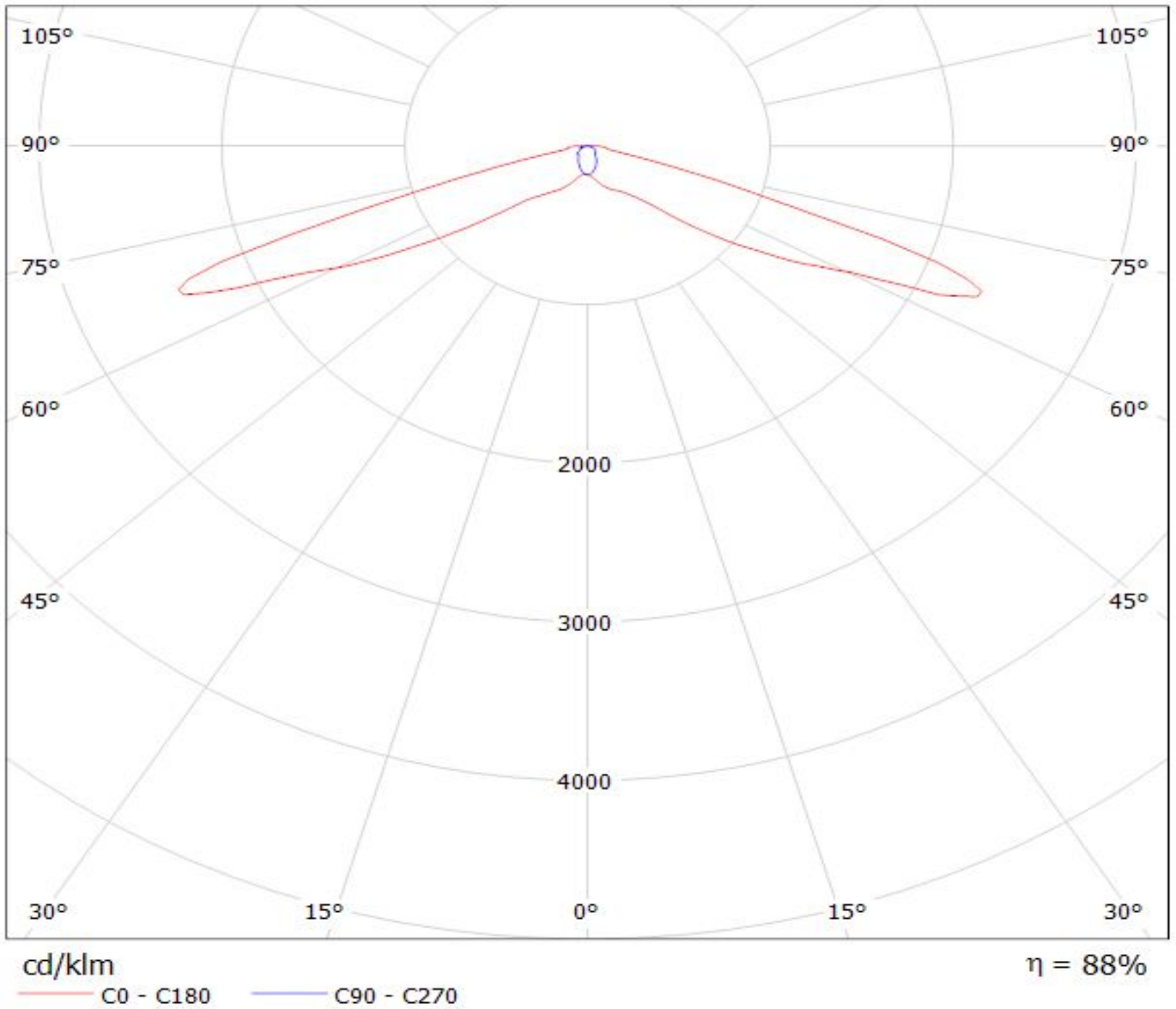

# LEDiL Oy CA13156\_EMERALD-A\_(NVS19) Eff.87.5% / LDC (Polar)

Luminaire: LEDiL Oy CA13156\_EMERALD-A\_(NVS19) Eff.87.5%  
Lamps: 1 x NVS19 (98.3lm@250mA)

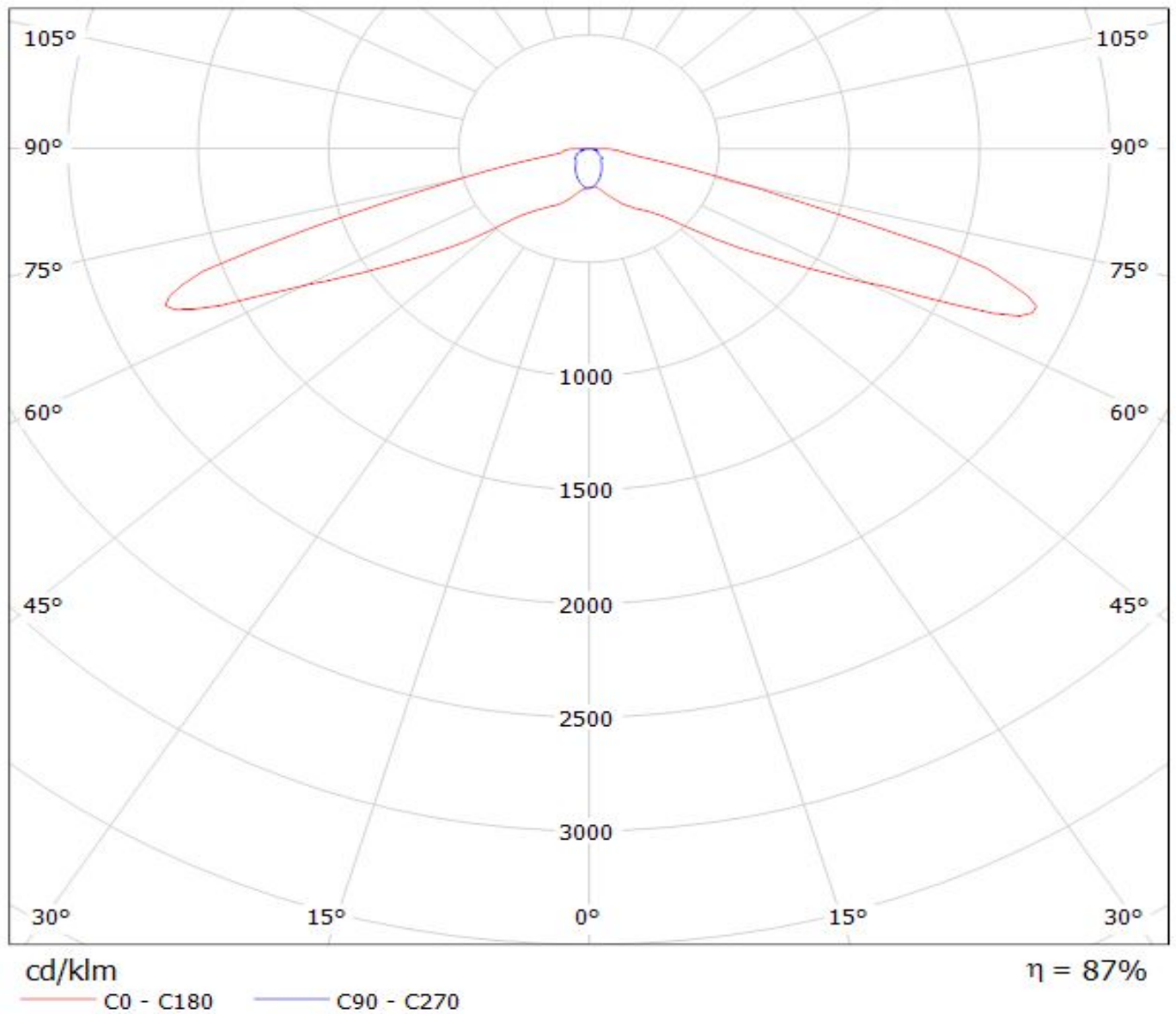



Luminaire: LEDiL Oy CA13156\_EMERALD-A\_(NS9x383) Eff. 89,2%  
Lamps: 1 x Nichia NS9x383 (105lm@250mA)

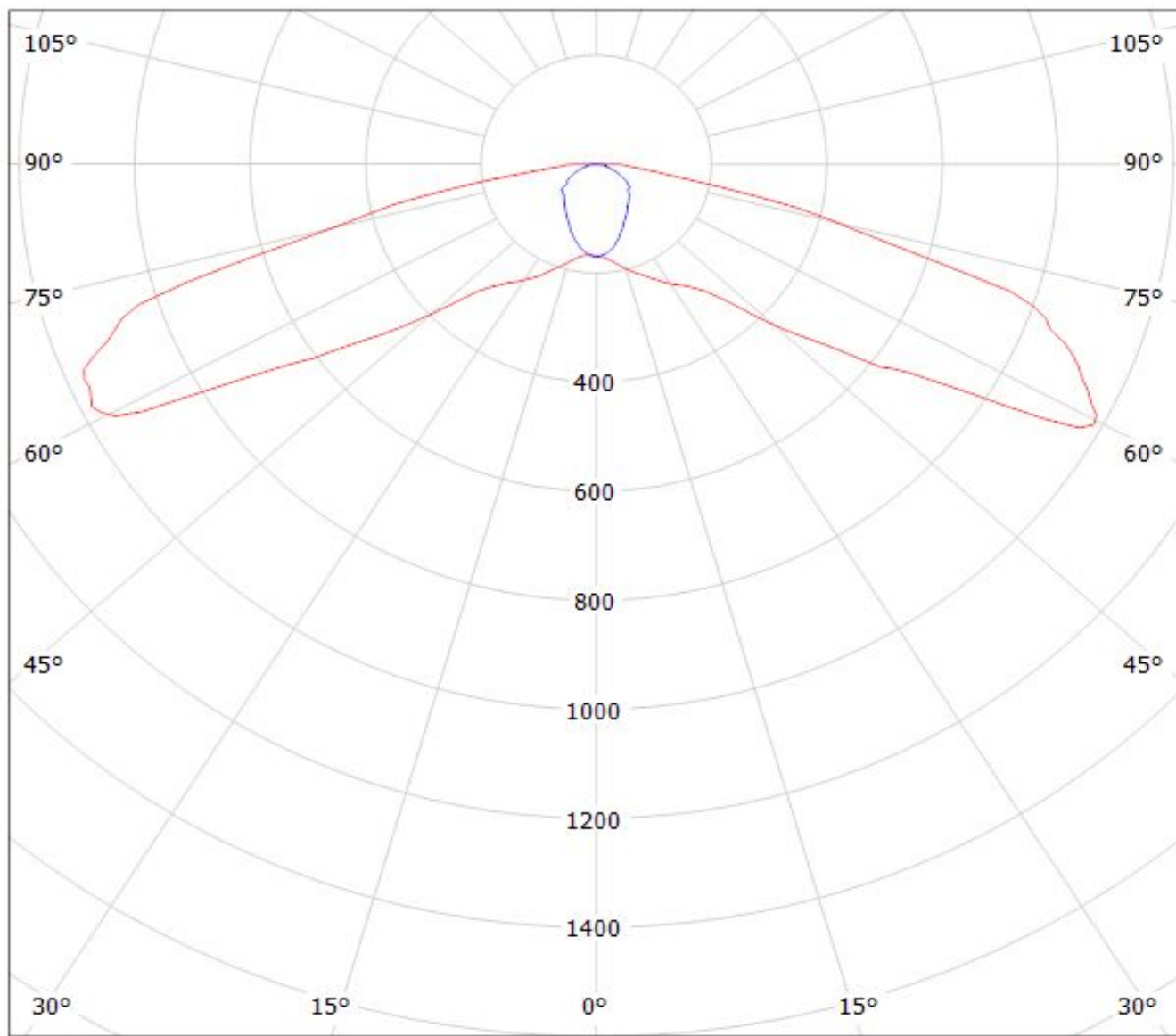

cd/klm

— C0 - C180    — C90 - C270

$\eta = 89\%$



Luminaire: LEDiL Oy CA13156\_EMERALD-A\_(NVSL219CE)

Lamps: 1 x Nichia\_NVSL219CE\_101.227lm@250mA\_P=0.713404W\_I=0.25A

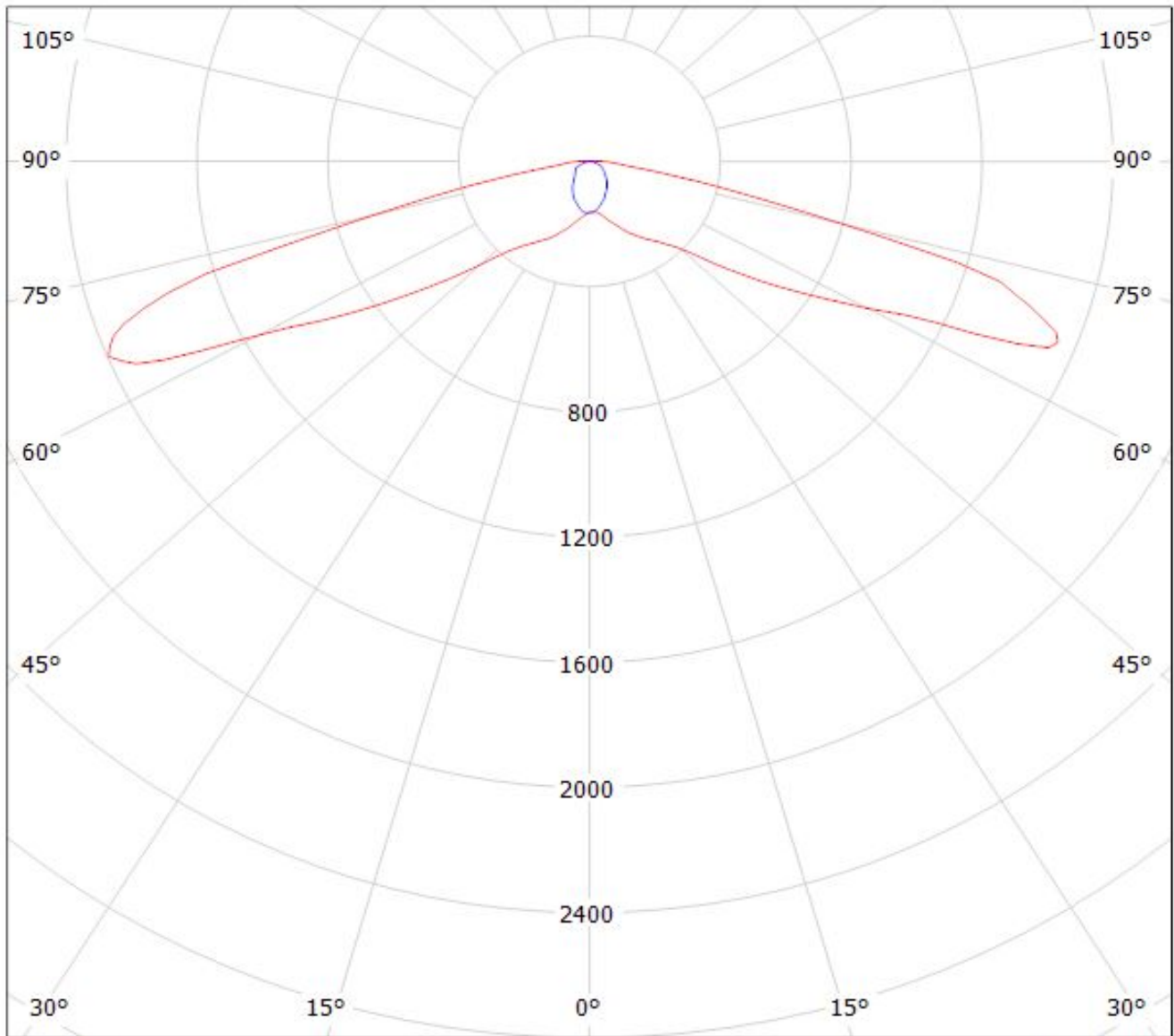

cd/klm

$\eta = 87\%$

— C0 - C180

— C90 - C270

# LEDiL Oy CA13156\_EMERALD-A\_(SQ-EC) Eff.89.6% / LDC (Polar)

Luminaire: LEDiL Oy CA13156\_EMERALD-A\_(SQ-EC) Eff.89.6%  
Lamps: 1 x SQ-EC (64.5908lm@250mA)

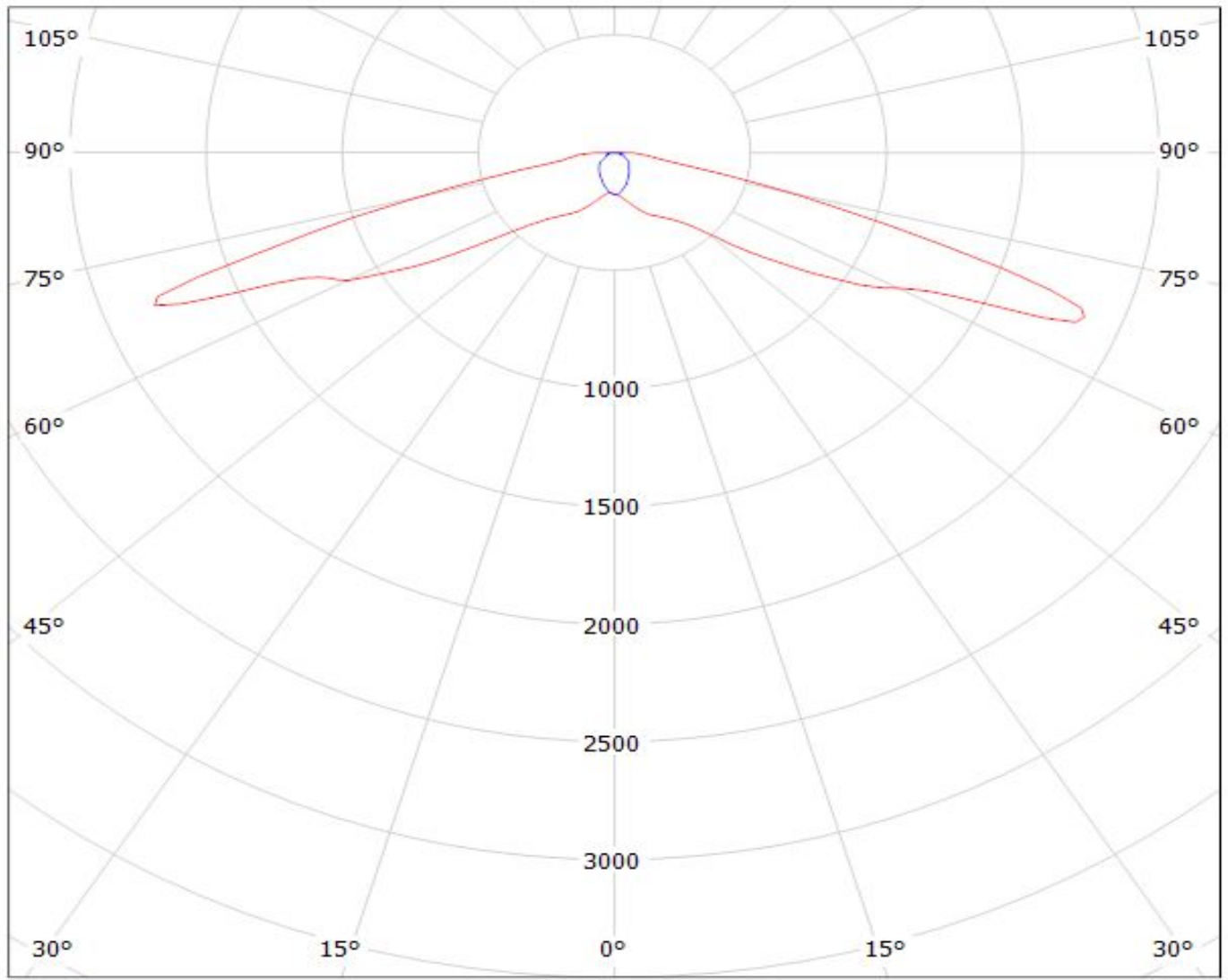

cd/klm

$\eta = 90\%$

— C0 - C180    — C90 - C270

# LEDiL Oy CA13156\_EMERALD-A\_(SQ-PC) Eff.89.1% / LDC (Polar)

Luminaire: LEDiL Oy CA13156\_EMERALD-A\_(SQ-PC) Eff.89.1%  
Lamps: 1 x SQ-PC (79.1971lm@250mA)

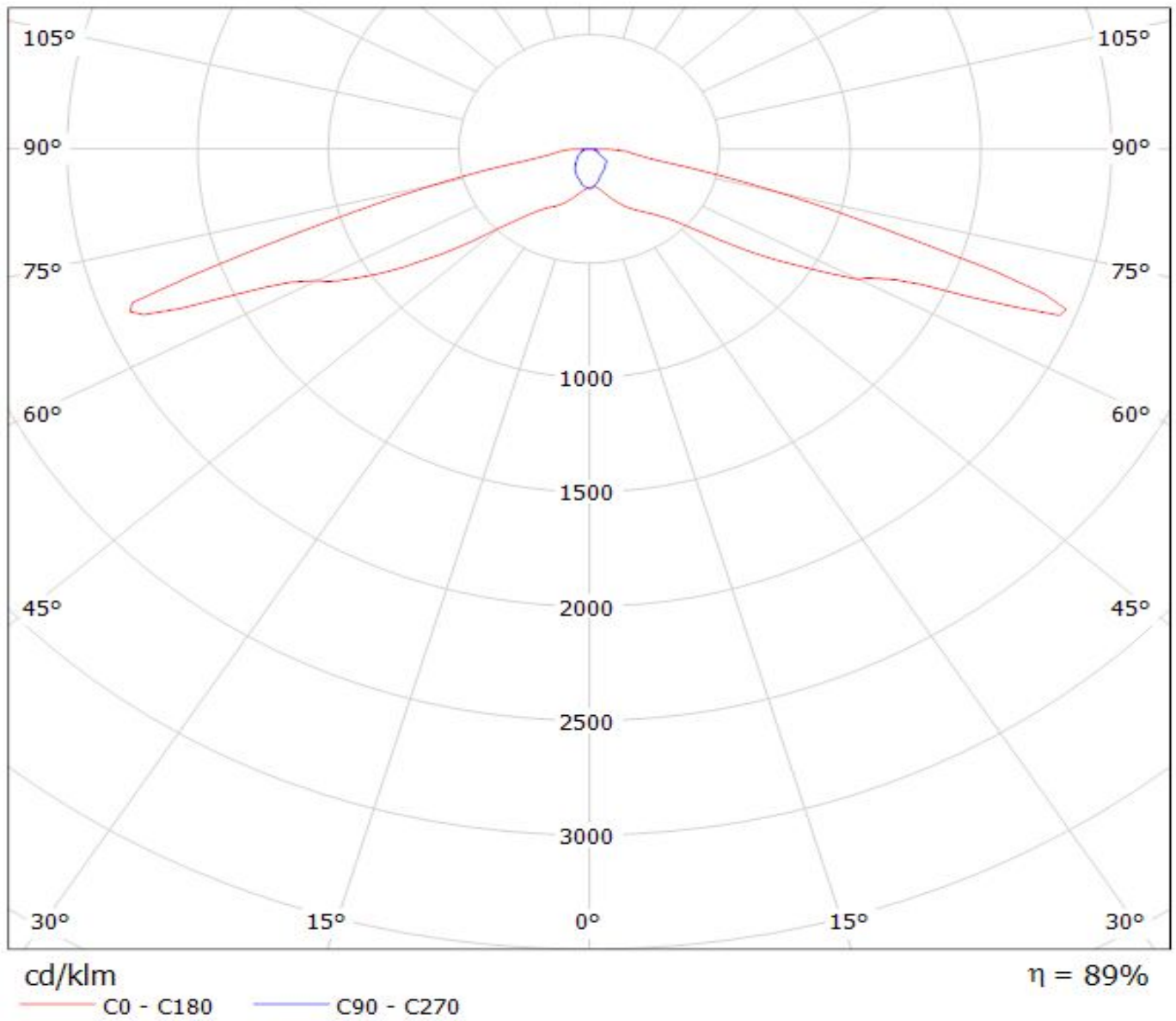

# LEDiL Oy CA13156\_EMERALD-A\_(SSL150) Eff.91.4% / LDC (Polar)

Luminaire: LEDiL Oy CA13156\_EMERALD-A\_(SSL150) Eff.91.4%

Lamps: 1 x Oslon SSL150 (71.5lm@250mA)

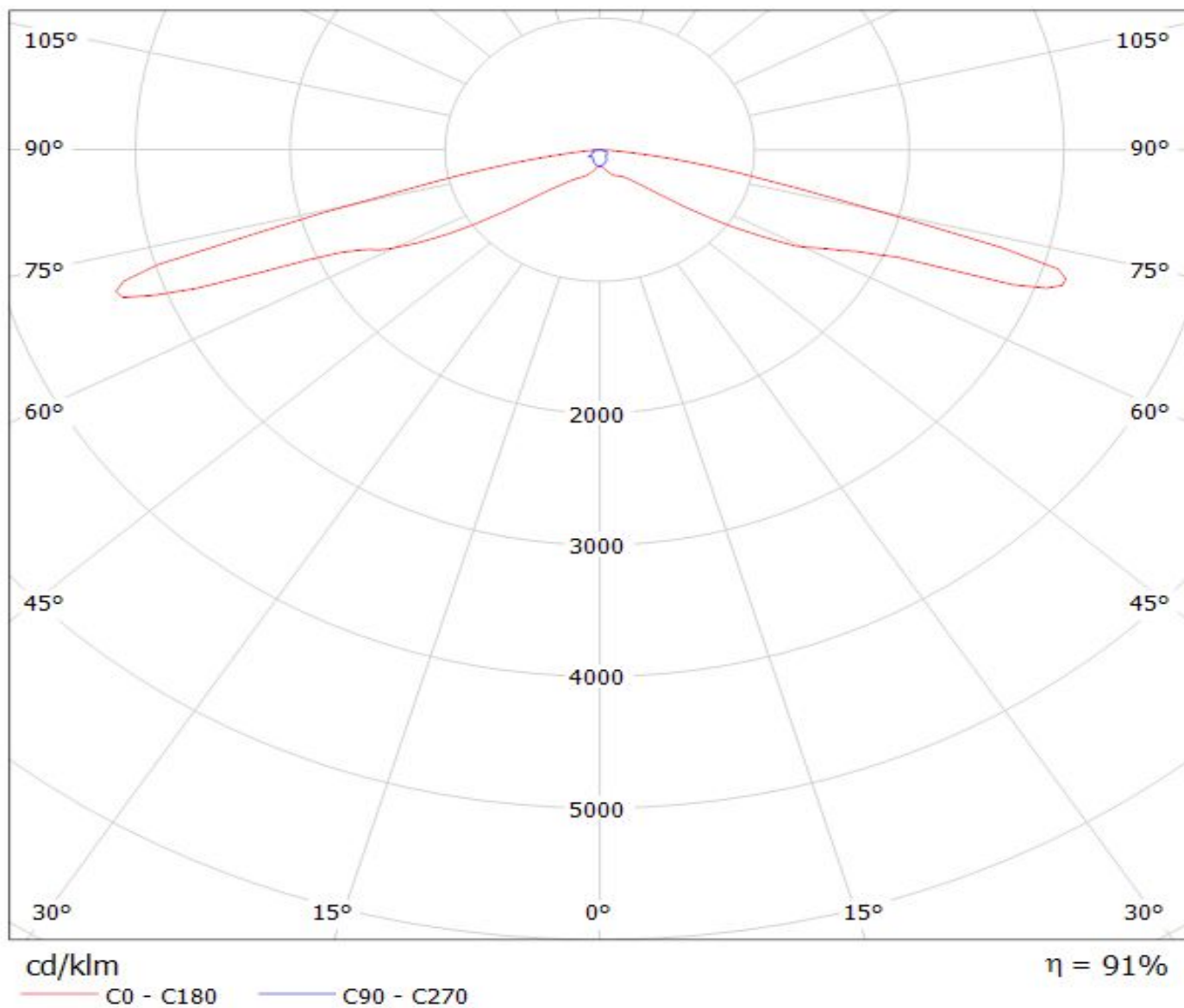

# LEDiL Oy C13155\_EMERALD-A\_(SSL80) Eff.89.4% / LDC (Polar)

Luminaire: LEDiL Oy C13155\_EMERALD-A\_(SSL80) Eff.89.4%

Lamps: 1 x Oslon SSL (81.3lm@250mA)

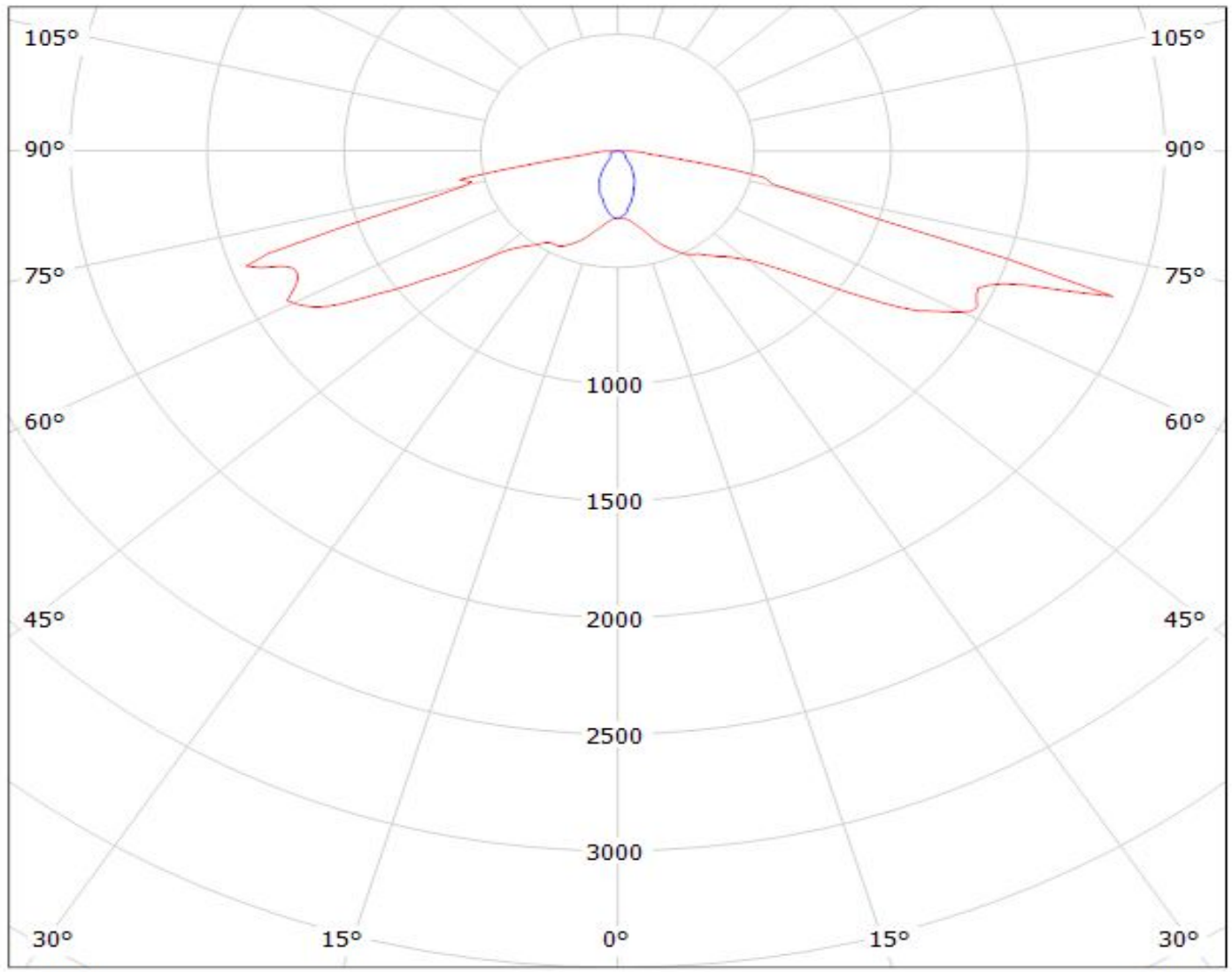

cd/klm

— C0 - C180

— C90 - C270

$\eta = 89\%$

Luminaire: LEDiL Oy CA13156\_EMERALD-A\_(Square\_Giant) Osram\_Square\_Giant\_113.056lm@250mA\_P=0.722\_I=250mA  
Lamps: 1 x Osram\_Square\_Giant\_113.056lm@250mA\_P=0.722\_I=250mA

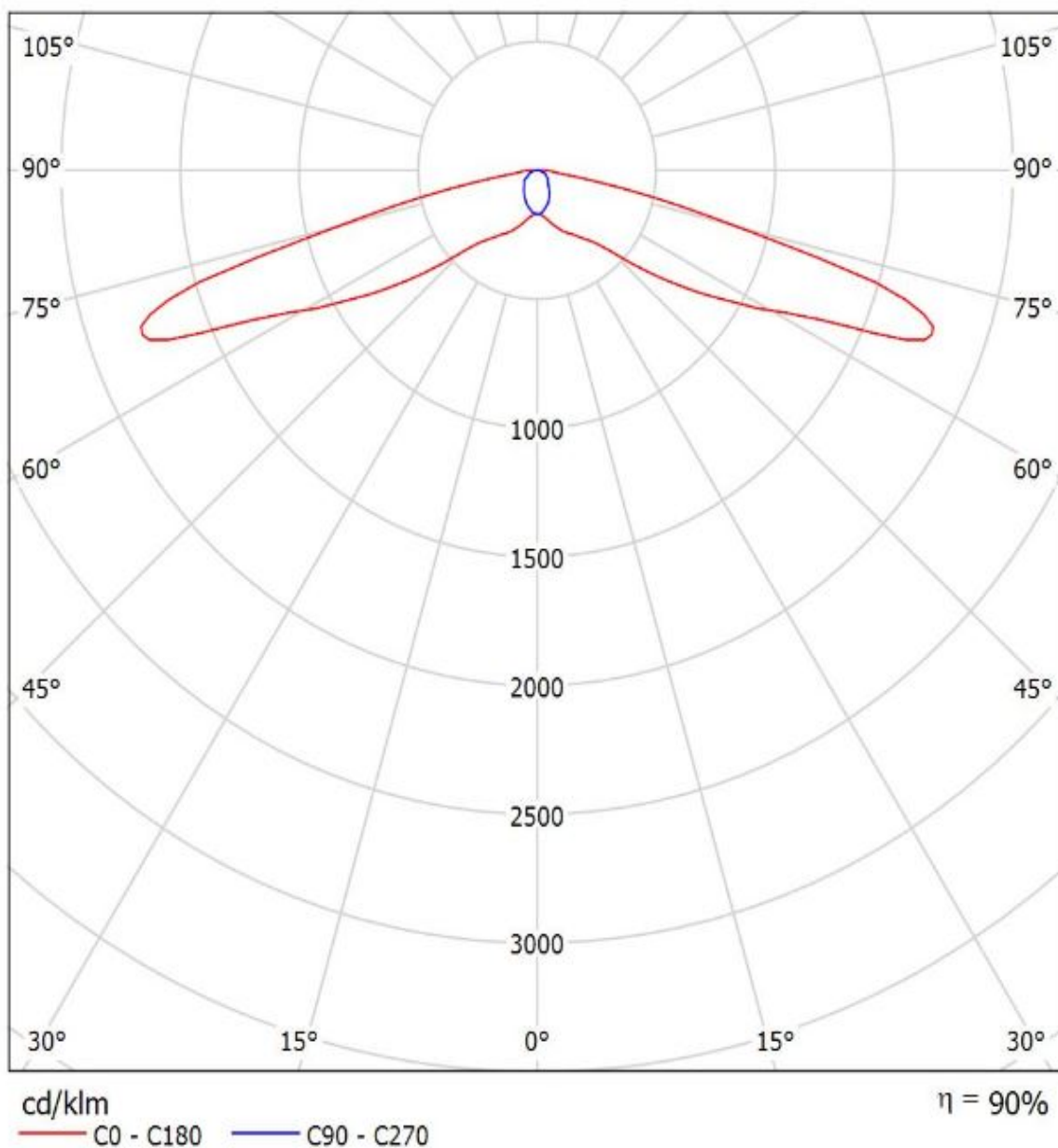



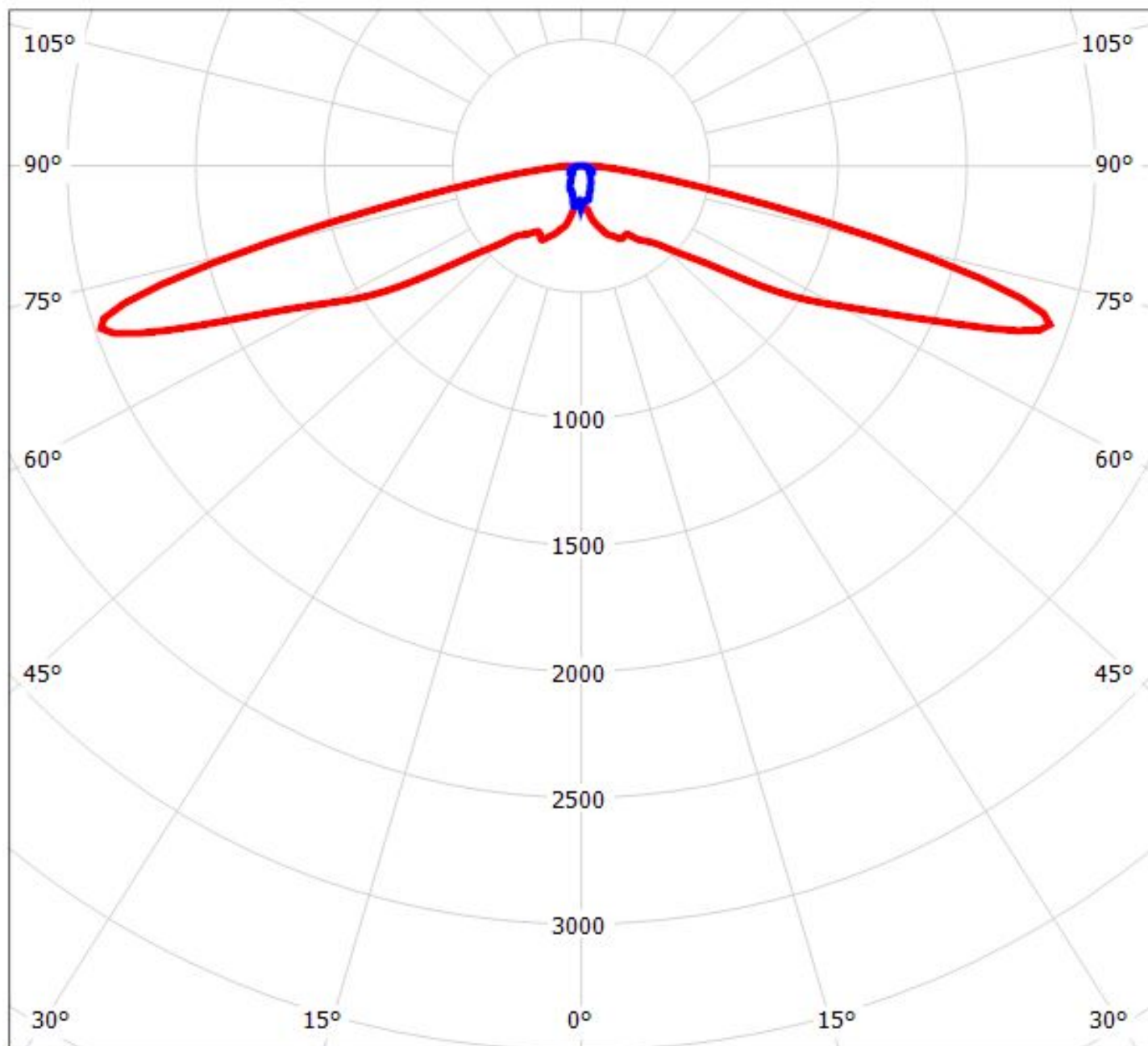

cd/klm

— C0 - C180

— C90 - C270

$\eta = 89\%$



**NOTE: The typical divergence will be changed by different color, chip size and chip position tolerance. The typical total divergence is the full angle measured where the luminous intensity is half of the peak value.**