

MAXIM

Dual, Rail-to-Rail, High-Output-Drive Op Amp in UCSP

MAX4369

General Description

The MAX4369 dual, high-output-drive op amp combines single-supply operation with high-output-current drive, Rail-to-Rail® outputs in an ultra chip-scale package (UCSP™). The device is unity-gain stable to 3.5MHz and operates from a single 2.3V to 5.5V supply. The MAX4369 is guaranteed to source and sink up to 87mA with a 5V supply.

The MAX4369 is capable of delivering 120mW of continuous average power to a 16Ω load, or 75mW to a 32Ω load with 1% total harmonic distortion plus noise (THD + N), making the device ideal for portable audio applications.

The MAX4369 is specified over the extended temperature range (-40°C to +85°C) and is available in a tiny (1.5mm x 1.5mm) 9-bump UCSP.

Applications

Cellular Phones	PDA's
Headphones	DC Motor Control
Headsets	General-Purpose Audio

Features

- ◆ Tiny UCSP (1.5mm x 1.5mm)
- ◆ Drives 120mW into 16Ω
- ◆ 0.03% THD + N at 1kHz
- ◆ 2.3V to 5.5V Single-Supply Operation
- ◆ 1mA Supply Current Per Amplifier
- ◆ Very High Power-Supply Rejection Ratio (96dB)
- ◆ Unity-Gain Stable
- ◆ Rail-to-Rail Output Stage
- ◆ Thermal Overload and Short-Circuit Protection

Ordering Information

PART	TEMP RANGE	BUMP-PACKAGE	TOP MARK
MAX4369EBL-T	-40°C to +85°C	9 UCSP-9	AAN

Bump Configuration appears at end of data sheet.

Typical Application Circuit/Functional Diagram

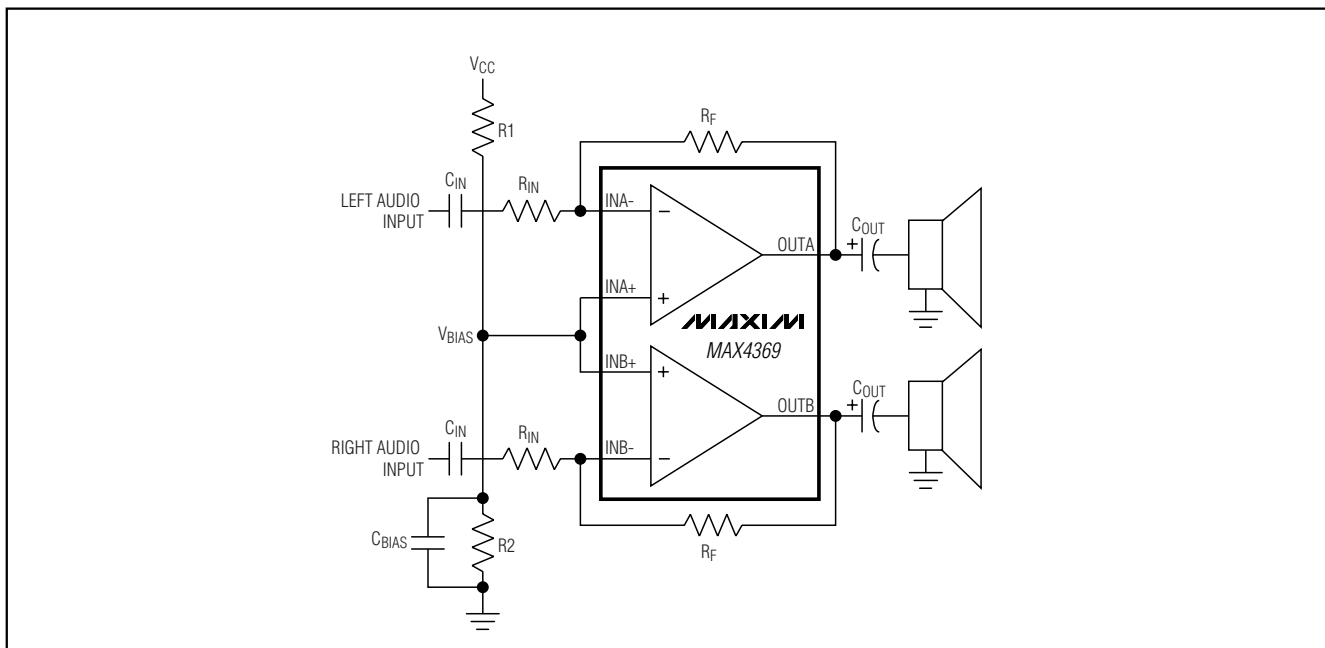

Rail-to-Rail is a registered trademark of Nippon Motorola, Ltd.
UCSP is a trademark of Maxim Integrated Products, Inc.

MAXIM

Maxim Integrated Products 1

For pricing, delivery, and ordering information, please contact Maxim/Dallas Direct! at 1-888-629-4642, or visit Maxim's website at www.maxim-ic.com.

Dual, High-Output-Drive, UCSP, Rail-to-Rail Output Op Amp

ABSOLUTE MAXIMUM RATINGS

V_{CC} to GND-0.3V to +6V
 All Other Pins to GND.....-0.3V to (V_{CC} + 0.3V)
 Output Short Circuit to V_{CC} or GND (Note 1).....Continuous
 Continuous Power Dissipation (T_A = +70°C)
 9-Bump USCP (derate 4.7mW/°C above +70°C).....379mW
 Operating Temperature Range-40°C to +85°C

Junction Temperature+150°C
 Storage Temperature Range-65°C to +150°C
 Bump Temperature (soldering) (Note 2)
 Infrared (15s)+220°C
 Vapor Phase (60s)+215°C

Note 1: Continuous power dissipation must also be observed.

Note 2: This device is constructed using a unique set of packaging techniques that impose a limit on the thermal profile that the device can be exposed to during board-level solder attach and rework. This limit permits only the use of the solder profiles recommended in the industry standard specification, JEDEC 020A, paragraph 7.6, Table 3 for IR/VPB and convection reflow. Preheating is required. Hand or wave soldering is not allowed.

Stresses beyond those listed under "Absolute Maximum Ratings" may cause permanent damage to the device. These are stress ratings only, and functional operation of the device at these or any other conditions beyond those indicated in the operational sections of the specifications is not implied. Exposure to absolute maximum rating conditions for extended periods may affect device reliability.

ELECTRICAL CHARACTERISTICS

(V_{CC} = 5V, V_{CM} = 0, V_{OUT} = V_{CC}/2, R_L = ∞ connected to V_{CC}/2, T_A = T_{MIN} to T_{MAX}, unless otherwise noted. Typical values are at T_A = +25°C.) (Note 3)

PARAMETER	SYMBOL	CONDITIONS		MIN	TYP	MAX	UNITS
Supply Voltage Range	V _{CC}	Inferred from PSRR test		2.3		5.5	V
Supply Current Per Amplifier	I _{CC}				1	2.2	mA
Input Offset Voltage	V _{OS}				±0.35	±5	mV
Open-Loop Voltage Gain	A _v	0.6V ≤ V _{OUT} ≤ V _{CC} - 0.6V	R _L = 10kΩ		88		dB
			R _L = 32Ω	80	84		
Input Bias Current	I _B				0.2	3	μA
Input Offset Current	I _{OS}				0.01	0.3	μA
Input Common-Mode Range	V _{CM}	Inferred from CMRR test		0		V _{CC} - 1.0	V
Differential Input Resistance	R _{IN(DIFF)}	V _{IN+} - V _{IN-} = ±10mV			500		kΩ
Power-Supply Rejection Ratio	PSRR	2.3V ≤ V _{CC} ≤ 5.5V		80	96		dB
Common-Mode Rejection Ratio	CMRR	0 ≤ V _{CM} ≤ V _{CC} - 1.0V		70	80		dB
Output Source/Sink Current	I _{OUT}	2.7V ≤ V _{CC} ≤ 5.5V, 0.6V ≤ V _{OUT} ≤ V _{CC} - 0.6V		±87	±125		mA
		2.3V ≤ V _{CC} ≤ 2.7V, 0.6V ≤ V _{OUT} ≤ V _{CC} - 0.6V		±115			
Output Voltage Swing	V _{OUT}	2.7V ≤ V _{CC} ≤ 5.5V	R _L = 10kΩ	V _{CC} - V _{OH}	300		mV
				V _{OL}	15		
			R _L = 32Ω	V _{CC} - V _{OH}	330	600	
				V _{OL}	180	600	
			R _L = 16Ω	V _{CC} - V _{OH}	350		
				V _{OL}	310		
Output Power	P _{OUT}	THD + N = 1%, f = 1kHz (Note 4)	R _L = 16Ω		120		mW
			R _L = 32Ω	56	75		
Total Harmonic Distortion Plus Noise	THD + N	f = 1kHz (Note 5)	P _{OUT} = 100mW, R _L = 16Ω		0.05		%
			P _{OUT} = 65mW, R _L = 32Ω		0.03		
Unity-Gain Bandwidth	BW				3.5		MHz
Gain-Bandwidth Product	GBWP				3.5		MHz

Dual, Rail-to-Rail, High-Output-Drive Op Amp in UCSP

MAX4369

ELECTRICAL CHARACTERISTICS (continued)

($V_{CC} = 5V$, $V_{CM} = 0$, $V_{OUT} = V_{CC}/2$, $R_L = \infty$ connected to $V_{CC}/2$, $T_A = T_{MIN}$ to T_{MAX} , unless otherwise noted. Typical values are at $T_A = +25^\circ C$.) (Note 3)

PARAMETER	SYMBOL	CONDITIONS	MIN	TYP	MAX	UNITS
Full-Power Bandwidth	FPBW			25		kHz
Phase Margin	PM			73		degrees
Gain Margin	GM			27		dB
Crosstalk				90		dB
Signal-to-Noise Ratio	SNR	$V_{OUT} = 1.5V_{RMS}$, $A_V = 1V/V$ (Note 5)		100		dB
Slew Rate	SR			1		V/ μs
Settling Time	t_s	Settling to 0.1%		10		μs
Input Capacitance	C_{IN}			1		pF
Input-Voltage Noise Density	e_n	$f = 1kHz$		40		nV/ \sqrt{Hz}
Input-Current Noise Density	i_n	$f = 1kHz$		1.5		pA/ \sqrt{Hz}
Capacitive-Load Stability		$A_V = -1V/V$, no sustained oscillations		200		pF
Short-Circuit Current	I_{SC}	To V_{CC}		185		mA
		To GND		215		
Thermal Shutdown Threshold				165		$^\circ C$
Thermal Shutdown Hysteresis				10		$^\circ C$
Power-Up Time	t_{PU}			25		μs

Note 3: All specifications are 100% tested at $T_A = +25^\circ C$; temperature limits are guaranteed by design.

Note 4: Guaranteed by design. Not production tested.

Note 5: Measurement bandwidth is 22Hz to 22kHz.

Typical Operating Characteristics

(THD + N measurement bandwidth = 22Hz to 22kHz, $T_A = +25^\circ C$, unless otherwise noted.)

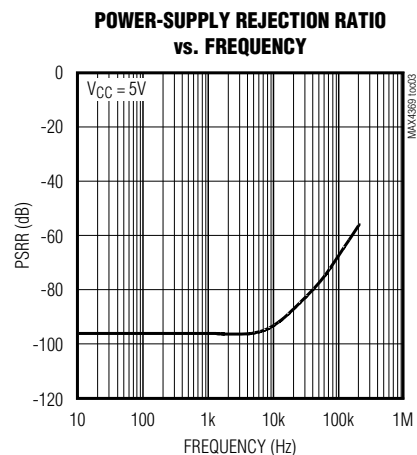
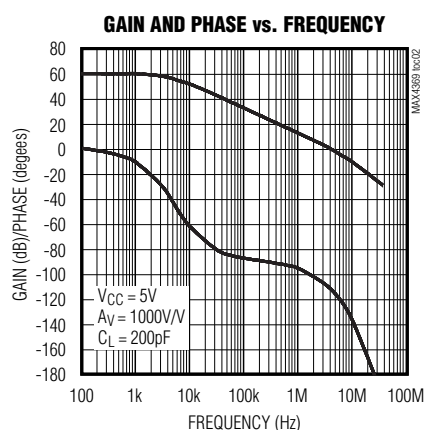
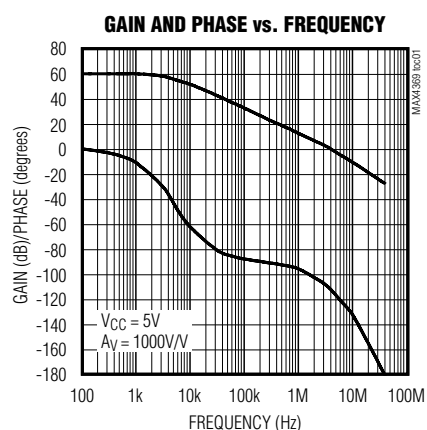

Dual, Rail-to-Rail, High-Output-Drive Op Amp in UCSP

Typical Operating Characteristics (continued)

(THD + N measurement bandwidth = 22Hz to 22kHz, $T_A = +25^\circ\text{C}$, unless otherwise noted.)

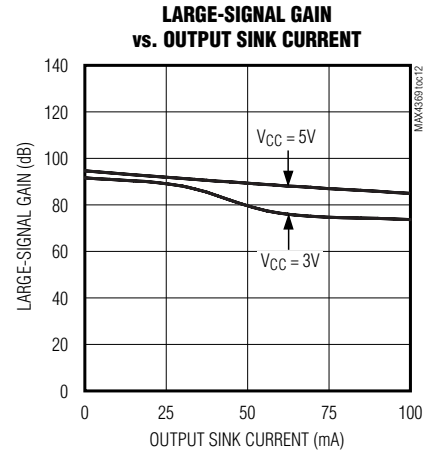
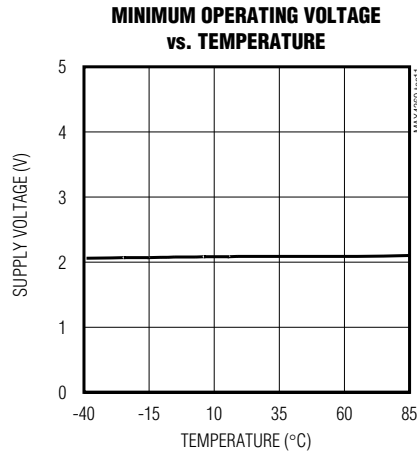
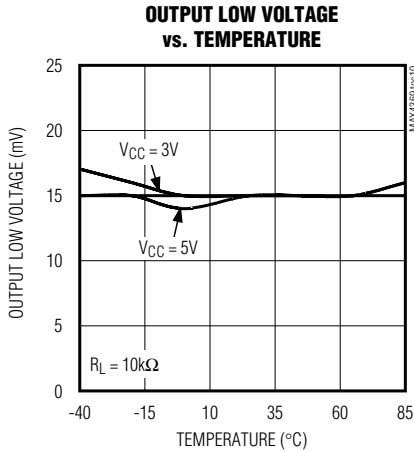
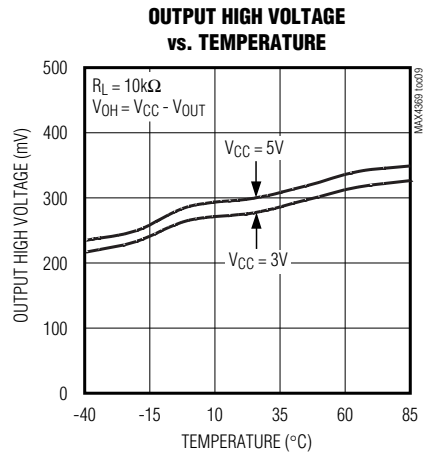
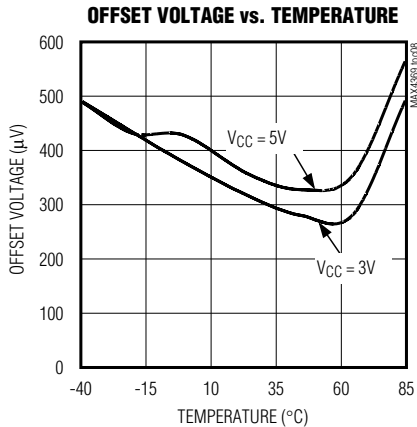
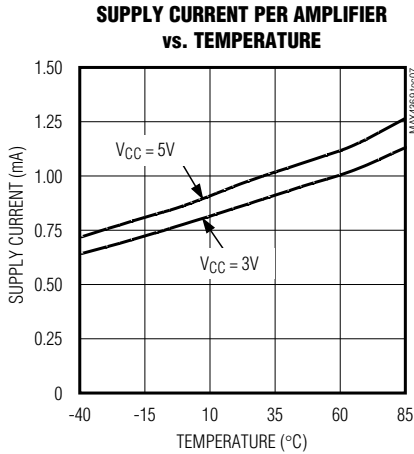
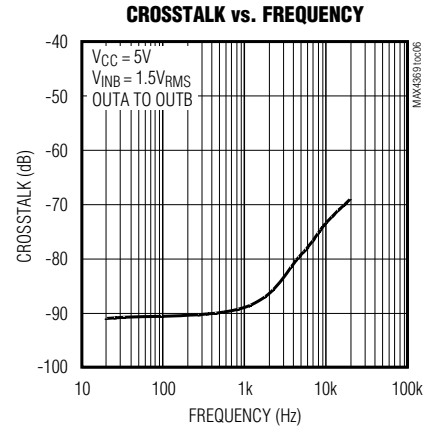
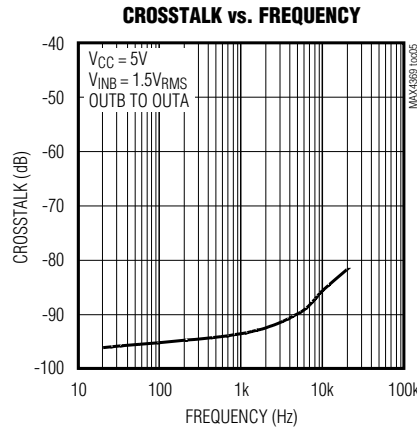
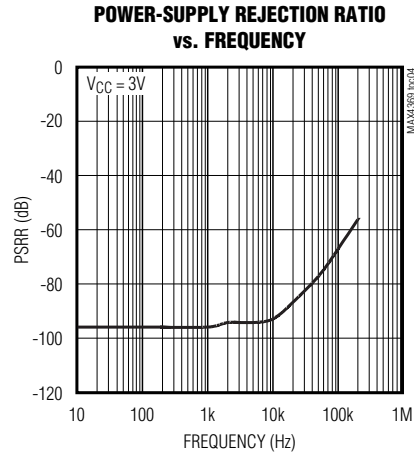

Dual, Rail-to-Rail, High-Output-Drive Op Amp in UCSP

MAX4369

Typical Operating Characteristics (continued)

(THD + N measurement bandwidth = 22Hz to 22kHz, $T_A = +25^\circ\text{C}$, unless otherwise noted.)

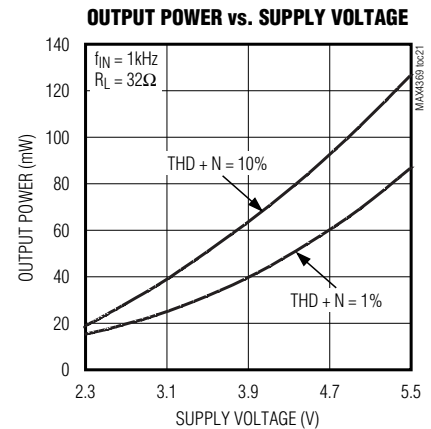
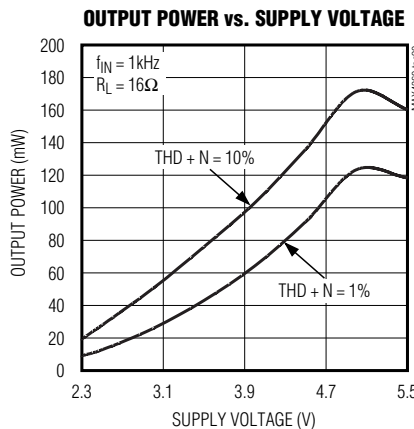
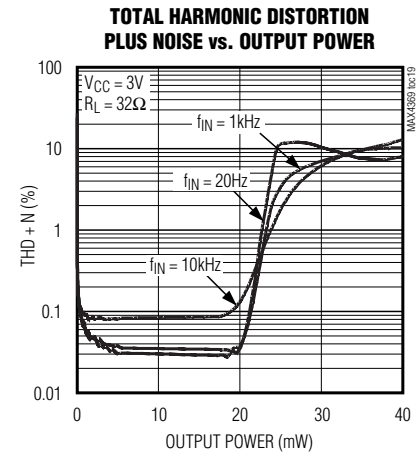
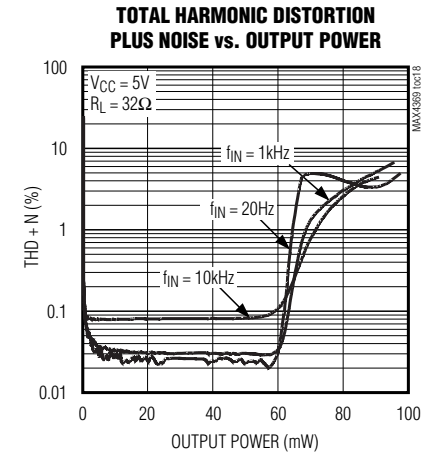
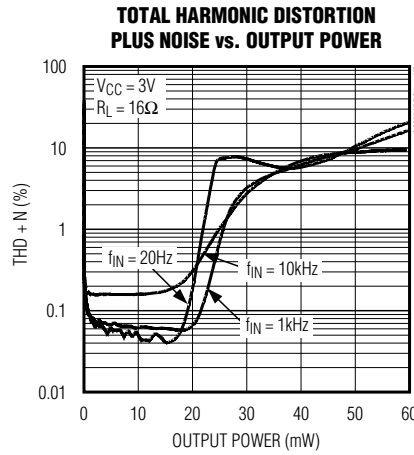
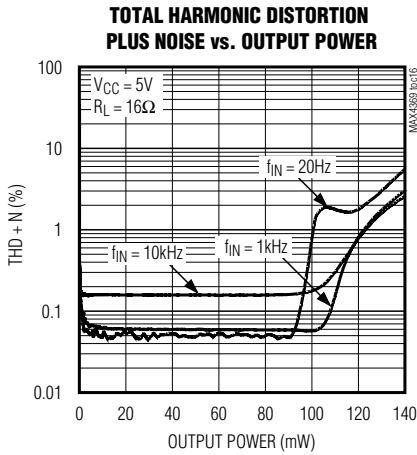
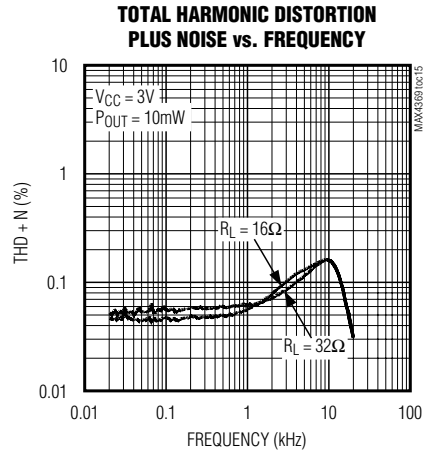
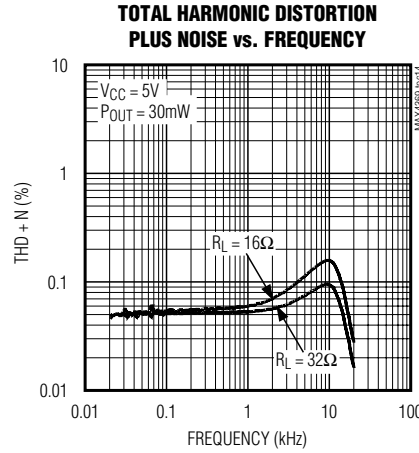
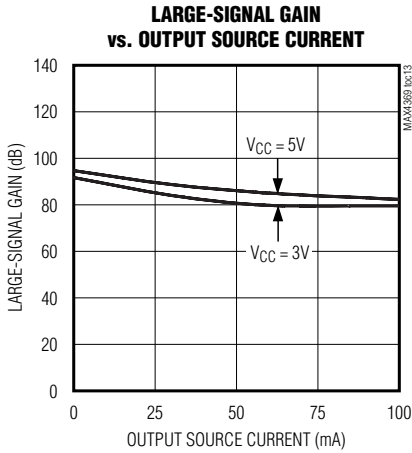

Dual, Rail-to-Rail, High-Output-Drive Op Amp in UCSP

Typical Operating Characteristics (continued)

(THD + N measurement bandwidth = 22Hz to 22kHz, $T_A = +25^\circ\text{C}$, unless otherwise noted.)

SMALL-SIGNAL TRANSIENT RESPONSE (NONINVERTING)

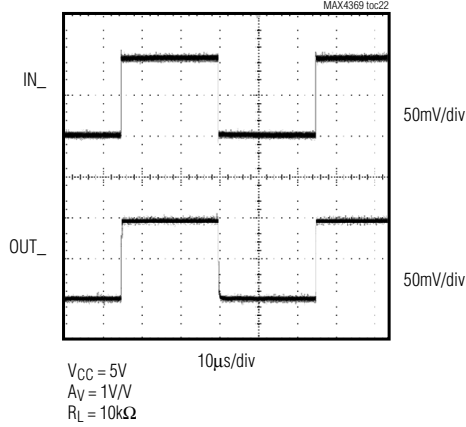

SMALL-SIGNAL TRANSIENT RESPONSE (INVERTING)

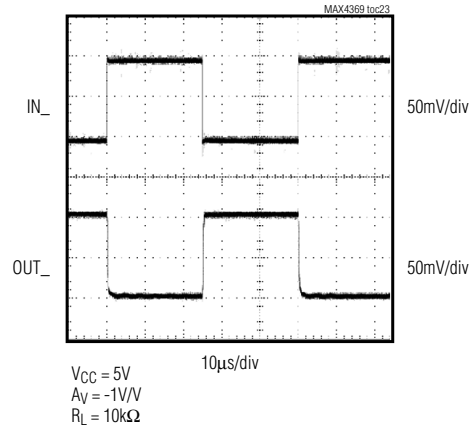

LARGE-SIGNAL TRANSIENT RESPONSE (NONINVERTING)

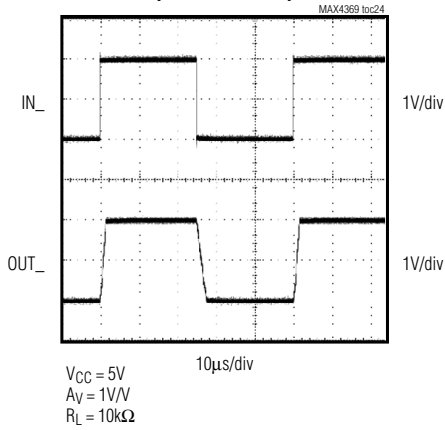

LARGE-SIGNAL TRANSIENT RESPONSE (INVERTING)

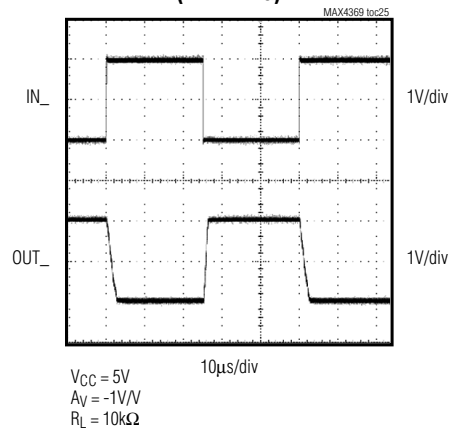

Dual, Rail-to-Rail, High-Output-Drive Op Amp in UCSP

Bump Description

BUMP	NAME	FUNCTION
A1	INA-	Amplifier A Inverting Input
A2	OUTA	Amplifier A Output
A3	INA+	Amplifier A Noninverting Input
B1	GND	Ground
B2	—	Not Populated
B3	VCC	Power Supply
C1	INB-	Amplifier B Inverting Input
C2	OUTB	Amplifier B Output
C3	INB+	Amplifier B Noninverting Input

Detailed Description

Rail-to-Rail Output

The MAX4369 can drive a 10kΩ load and still swing within 300mV of the positive-supply rail, and 15mV of the negative-supply rail. Figure 1 shows the output voltage swing of the MAX4369 configured with $A_V = 2V/V$.

Driving Capacitive Loads

Driving a capacitive load can cause instability in many op amps. The MAX4369 is unity-gain stable for a range of capacitive loads to 200pF. Figure 2 shows the response of the MAX4369 with an excessive capacitive load. Adding a series resistor between the output and the output capacitor improves the circuit's response by isolating the load capacitance from the op amp's output.

Applications Information

Power Dissipation

Under normal operating conditions, linear power amplifiers like the MAX4369 can dissipate a significant amount of power. The maximum power dissipation of the UCSP package is given in the *Absolute Maximum Ratings* section under Continuous Power Dissipation or can be calculated by the following equation:

$$P_{DISS(MAX)} = \frac{T_{J(MAX)} - T_A}{\theta_{JA}}$$

where $T_{J(MAX)}$ is +150°C and θ_{JA} is the reciprocal of the derating factor in °C/W as specified in the *Absolute Maximum Ratings*. For example, θ_{JA} of a UCSP package is 211°C/W.

If the power dissipation exceeds the maximum allowed for a given package, either reduce V_{CC} , increase load impedance, decrease the ambient temperature or add heat sinking to the device. Large output, supply, and ground traces improve the maximum power dissipation in the package.

Thermal overload protection limits total power dissipation in the MAX4369. When the junction temperature exceeds +165°C, the thermal protection circuitry disables the amplifier output stage. The amplifiers are enabled once the junction temperature cools by 10°C. This results in a pulsing output under continuous thermal overload conditions.

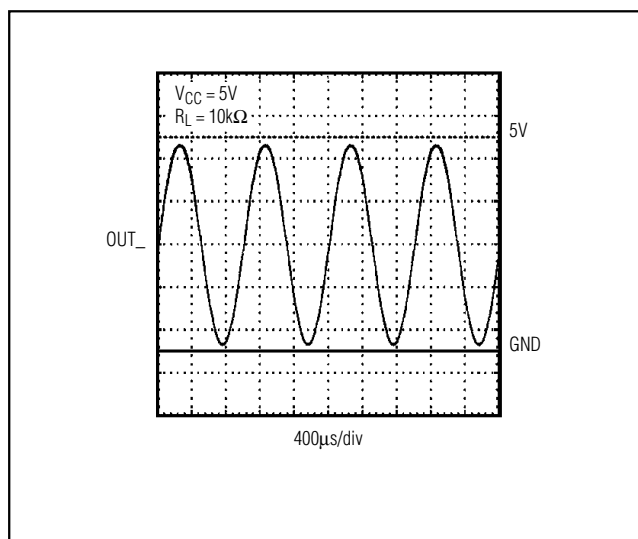

Figure 1. Rail-to-Rail Output Operation

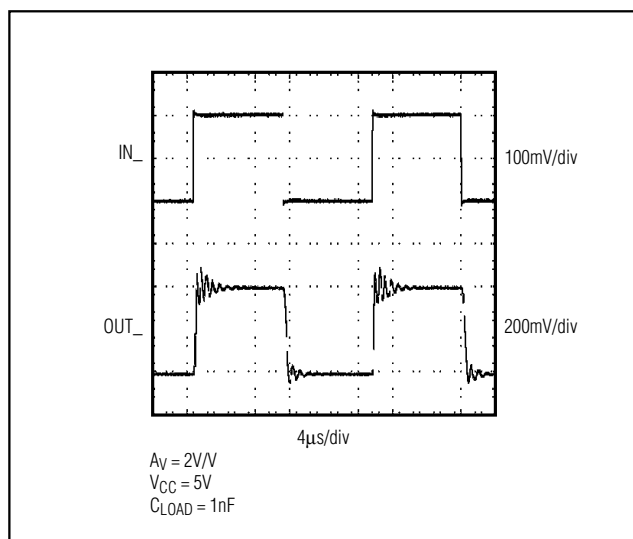

Figure 2. Small-Signal Transient Response with Excessive Capacitive Load

Dual, Rail-to-Rail, High-Output-Drive Op Amp in UCSP

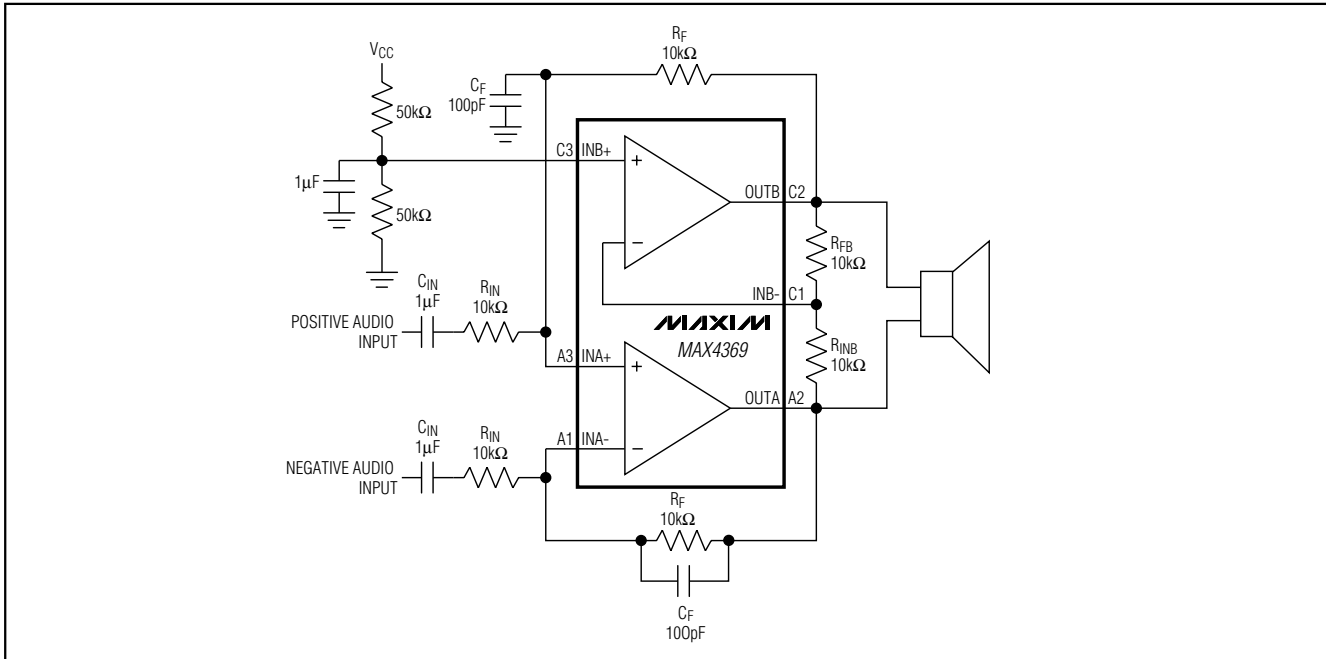

Figure 3. Differential Input/Differential Output Audio Amplifier

Supply Bypassing

Proper supply bypassing ensures low-noise, low-distortion performance. Place a 0.1µF ceramic capacitor in parallel with a 10µF capacitor from VCC to GND. Locate the bypass capacitors as close to the device as possible.

Layout Considerations

Good layout improves performance by decreasing the amount of stray capacitance and noise at the amplifier's inputs and outputs. Decrease stray capacitance by minimizing PC board trace lengths, using surface-mount components and placing external components as close to the device as possible.

UCSP Considerations

For general UCSP information and PC layout considerations, please refer to the Maxim Application Note: *Wafer-Level Ultra-Chip-Scale Package*.

Audio Applications

Single-Ended Stereo Amplifier

The high-output-current drive makes the MAX4369 ideal for use as a stereo audio amplifier (see *Typical Application Circuit/Functional Diagram*). In this configuration, the MAX4369 can deliver 120mW per channel into 16Ω with less than 1% THD + N. The input capacitors (CIN) block the DC component of the incoming

audio signal from the MAX4369. See the *Input Capacitor* section for selecting the value of CIN. The output capacitors (COUT) serve to block the DC bias of the MAX4369 from the speaker load. See the *Output Capacitor* section for selecting the value of COUT. Set the DC bias (typically VCC/2) by the resistive voltage-divider formed by R1 and R2. Ensure that the DC-bias level gives the incoming audio signal the maximum amount of headroom. COUT can be eliminated by operating the MAX4369 from a dual supply (±1.15V to ±2.5V) and setting the DC bias to 0.

Differential Input/Differential Output Audio Amplifier

The MAX4369 can be used as a differential input/differential output (BTL) amplifier (Figure 3). This configuration offers good CMRR, improved low-frequency PSRR, no large output-coupling capacitors compared to a single-ended amplifier. Resistors RINB and RFB configure the second amplifier as an inverting unity-gain follower. Connect the noninverting input of the second amplifier to a bias voltage, typically VCC/2. Resistors RIN and RF set the differential gain of the device as follows:

$$\frac{V_{OUT(DIFF)}}{V_{IN(DIFF)}} = \frac{R_F}{R_{IN}}$$

Dual, Rail-to-Rail, High-Output-Drive Op Amp in UCSP

The capacitors (C_F) are necessary to maintain stability. The amplifier has two feedback paths, one from OUTA to INA- and the other from OUTB to INA+. At high frequencies, the second amplifier in the OUTB to INA+ feedback path introduces excessive phase shift. Compensate this phase shift by adding a capacitor from INA+ to GND. This suppresses the gain of the device at high frequencies, maintaining stability. Placing an identical-valued capacitor from INA- to OUTA improves overall performance.

Proper matching of the R_F and R_{IN} components is essential for optimum performance. A resistor pack offers a cost-effective solution for these matched components.

Headphone Driver

The MAX4369 can drive a stereo headphone when configured as a single-ended stereo amplifier. Typical 3-wire headphone plugs consist of a tip, ring, and sleeve. The tip and ring are the signal carriers while the sleeve is the ground connection (Figure 4). Figure 5 shows the MAX4369 configured to drive a set of headphones. OUTB is coupled to the ring and OUTA is coupled to the tip, delivering the signal to the headphone.

Capacitor Selection

Input Capacitor

The input capacitor (C_{IN}), in conjunction with R_{IN} , forms a high-pass filter that removes the DC bias from an incoming signal (see the *Typical Application Circuit/Functional Diagram*). The AC-coupling capacitor allows the amplifier to bias the signal to an optimum DC level. Assuming zero-source impedance, the -3dB point of the high-pass filter is given by:

$$f_{-3dB} = \frac{1}{2\pi R_{IN} C_{IN}}$$

Choose C_{IN} such that f_{-3dB} is well below the lowest frequency of interest. Setting f_{-3dB} too high affects the low-frequency response of the amplifier. Use capacitors whose dielectrics have low-voltage coefficients,

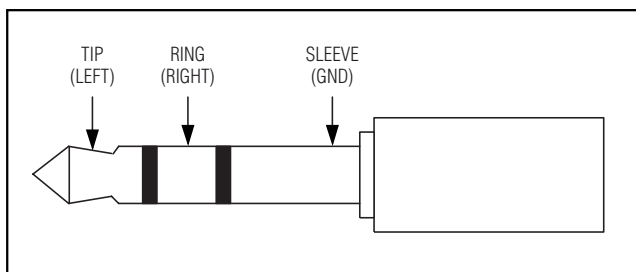

Figure 4. Typical 3-Wire Headphone Jack

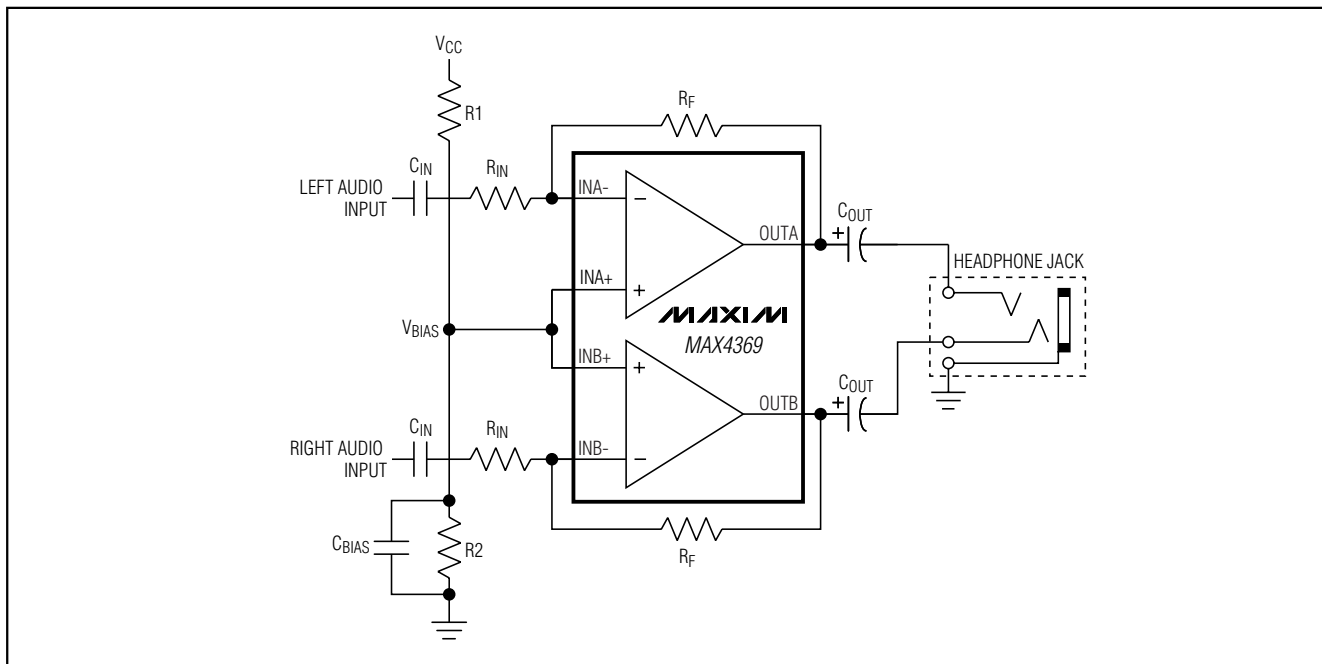

Figure 5. Stereo Headphone Driver

Dual, Rail-to-Rail, High-Output-Drive Op Amp in UCSP

such as tantalum or aluminum electrolytic. Capacitors with high-voltage coefficients, such as certain ceramics, can result in an increase in distortion at low frequencies.

Other considerations when designing the input filter include the constraints of the overall system, the actual frequency band of interest and click-and-pop suppression. Although high-fidelity audio calls for a flat gain response between 20Hz and 20kHz, portable voice-reproduction devices such as cellular phones and walkie-talkies need only concentrate on the frequency range of the spoken human voice (typically 300Hz to 3.5kHz). In addition, speakers used in portable devices typically have a poor response below 150Hz. Taking these two factors into consideration, the input filter might not need to be designed for a 20Hz to 20kHz response, saving both board space and cost due to the use of smaller capacitors.

Output-Coupling Capacitor

The MAX4369 requires an output-coupling capacitor when configured as a single-ended amplifier. The output capacitor blocks the DC component of the amplifier output, preventing DC current flowing to the load. The output capacitor and the load impedance form a high-pass filter with the -3dB point determined by:

$$f_{-3dB} = \frac{1}{2\pi R_L C_{OUT}}$$

As with the input capacitor, choose C_{OUT} such that f_{-3dB} is well below the lowest frequency of interest. Setting f_{-3dB} too high affects the low-frequency response of the amplifier.

In addition to frequency band considerations, the load impedance is another concern when choosing C_{OUT} . Load impedance can vary, changing the -3dB point of the output filter. A lower impedance increases the corner frequency, degrading low-frequency response. Select C_{OUT} such that the worst-case load/ C_{OUT} combination yields an adequate response.

Bump Configuration

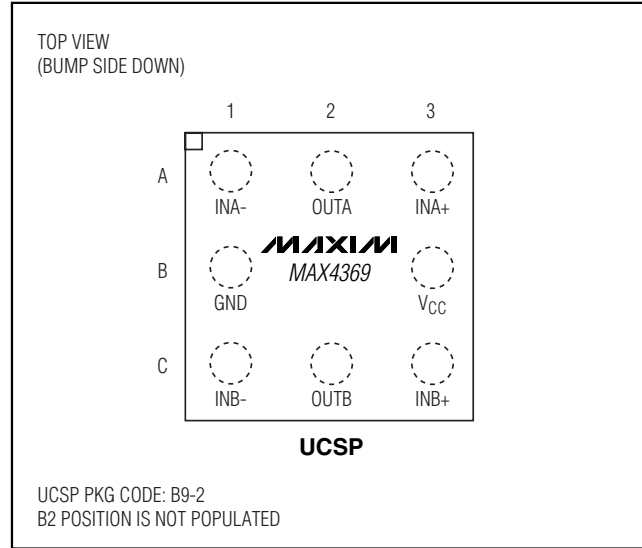

Chip Information

TRANSISTOR COUNT: 669

PROCESS: BiPOLAR

Dual, Rail-to-Rail, High-Output-Drive Op Amp in UCSP

MAX4369

Package Information

(The package drawing(s) in this data sheet may not reflect the most current specifications. For the latest package outline information, go to www.maxim-ic.com/packages.)

SYMBOL	DIMENSIONS
A	0.60±0.05
D	1.52±0.05
E	1.52±0.05
e	0.50 BASIC
b	∅ 0.35 BASIC
A1	0.27±0.04
A2	0.33 Ref.
hd	0.26 Ref.
he	0.26 Ref.

SOLDER BALL DEPOPULATION	
PKG. CODE	DEPOPULATED BALL
B9-1	NONE
B9-2	B2
B9-3	B1, B2, B3

TOP VIEW

NOTES:

- ALL DIMENSIONS ARE IN MILLIMETERS.
- MEETS JEDEC M0195.

BOTTOM VIEW

SIDE VIEW

MAXIM		
PROPRIETARY INFORMATION		
TITLE: PACKAGE OUTLINE, 3x3 UCSP		
APPROVAL	DOCUMENT CONTROL NO. 21-0093	REV. E 1/1

Maxim cannot assume responsibility for use of any circuitry other than circuitry entirely embodied in a Maxim product. No circuit patent licenses are implied. Maxim reserves the right to change the circuitry and specifications without notice at any time.

Maxim Integrated Products, 120 San Gabriel Drive, Sunnyvale, CA 94086 408-737-7600 _____ 11