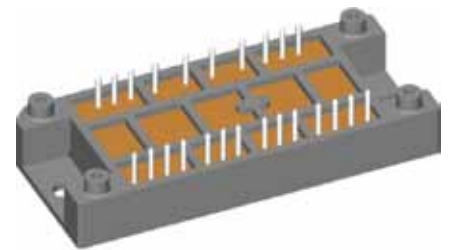
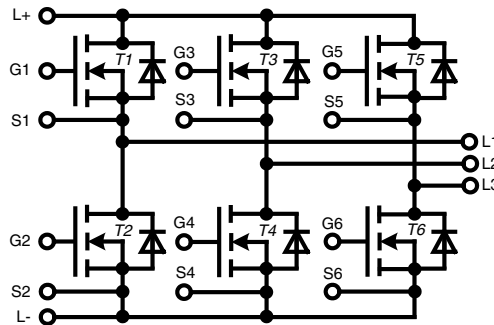

Three phase full bridge with Trench MOSFETs

$V_{DSS} = 75\text{ V}$
 $I_{D25} = 270\text{ A}$
 $R_{DS(on)} = 2.1\text{ m}\Omega$

MOSFET T1 - T6

Symbol	Conditions	Maximum Ratings	
V_{DSS}	$T_{VJ} = 25^\circ\text{C to } 150^\circ\text{C}$	75	V
V_{GS}		± 20	V
I_{D25}	$T_C = 25^\circ\text{C}$	270	A
I_{D80}	$T_C = 80^\circ\text{C}$	215	A
I_{F25}	$T_C = 25^\circ\text{C (diode)}$	280	A
I_{F80}	$T_C = 80^\circ\text{C (diode)}$	180	A

Applications
AC drives

- in automobiles
 - electric power steering
 - starter generator
- in industrial vehicles
 - propulsion drives
 - fork lift drives
- in battery supplied equipment

Features

- MOSFETs in trench technology:
 - low $R_{DS(on)}$
 - optimized intrinsic reverse diode
- package:
 - high level of integration
 - solder terminals for PCB mounting
 - isolated DCB ceramic base plate with optimized heat transfer

Symbol	Conditions	Characteristic Values			
		$(T_{VJ} = 25^\circ\text{C, unless otherwise specified})$			
		min.	typ.	max.	
$R_{DS(on)}^{1)}$	$V_{GS} = 10\text{ V}; I_D = 100\text{ A};$ on chip level			2.1	$\text{m}\Omega$
$V_{GS(th)}$	$V_{DS} = 20\text{ V}; I_D = 0.5\text{ mA}$	2		4	V
I_{DSS}	$V_{DS} = 75\text{ V}; V_{GS} = 0\text{ V}$			10	μA
	$T_{VJ} = 125^\circ\text{C}$			300	μA
I_{GSS}	$V_{GS} = \pm 20\text{ V}; V_{DS} = 0\text{ V}$			0.4	μA
Q_g	$V_{GS} = 10\text{ V}; V_{DS} = \frac{1}{2}V_{DSS}; I_D = 230\text{ A}$		360		nC
Q_{gs}			105		nC
Q_{gd}			80		nC
$t_{d(on)}$	inductive load $V_{GS} = 10\text{ V}; V_{DS} = 37\text{ V}$ $I_D = 230\text{ A}; R_G = 10\ \Omega$ $R_G = R_{G\text{ ext}} + R_{\text{out driver}}$ $T_{VJ} = 25^\circ\text{C}$		140		ns
t_r			225		ns
$t_{d(off)}$			380		ns
t_f			265		ns
E_{on}			0.23		mJ
E_{off}			3.49		mJ
E_{rec}			0.04		mJ
$t_{d(on)}$	inductive load $V_{GS} = 10\text{ V}; V_{DS} = 37\text{ V}$ $I_D = 230\text{ A}; R_G = 10\ \Omega$ $R_G = R_{G\text{ ext}} + R_{\text{out driver}}$ $T_{VJ} = 125^\circ\text{C}$		145		ns
t_r			240		ns
$t_{d(off)}$			410		ns
t_f			230		ns
E_{on}			0.3		mJ
E_{off}			2.95		mJ
E_{rec}			0.06		mJ
R_{thJC}	with heat transfer paste (IXYS test setup)			0.44	K/W
R_{thJH}			0.66		K/W

¹⁾ $V_{DS} = I_D \cdot (R_{DS(on)} + 2R_{Pin\ to\ chip})$

Source-Drain Diode

Symbol	Conditions	Characteristic Values			
		min.	typ.	max.	
(T _{VJ} = 25°C, unless otherwise specified)					
V _{SD}	I _F = 100 A; V _{GS} = 0 V			1.1	V
t _{rr}	I _F = 230 A; V _R = 37 V -di _F /dt = 820 A/μs; R _G = 10 Ω		85		ns
Q _{RM}			2.2		μC
I _{RM}			38		A

Module

Symbol	Conditions	Maximum Ratings	
T _{VJ}		-40...+175	°C
T _{stg}		-40...+125	°C
V _{ISOL}	I _{ISOL} ≤ 1 mA, 50/60 Hz; t = 1 min	500	V~
M _d	Mounting torque (M5)	2 - 2.5	Nm

Symbol	Conditions	Characteristic Values			
		min.	typ.	max.	
R _{pin to chip} ¹⁾				0.7	mΩ
Weight			80		g

¹⁾ V_{DS} = I_D · (R_{DS(on)} + 2R_{Pin to chip})

PHASE-OUT

Dimensions in mm (1 mm = 0.0394")

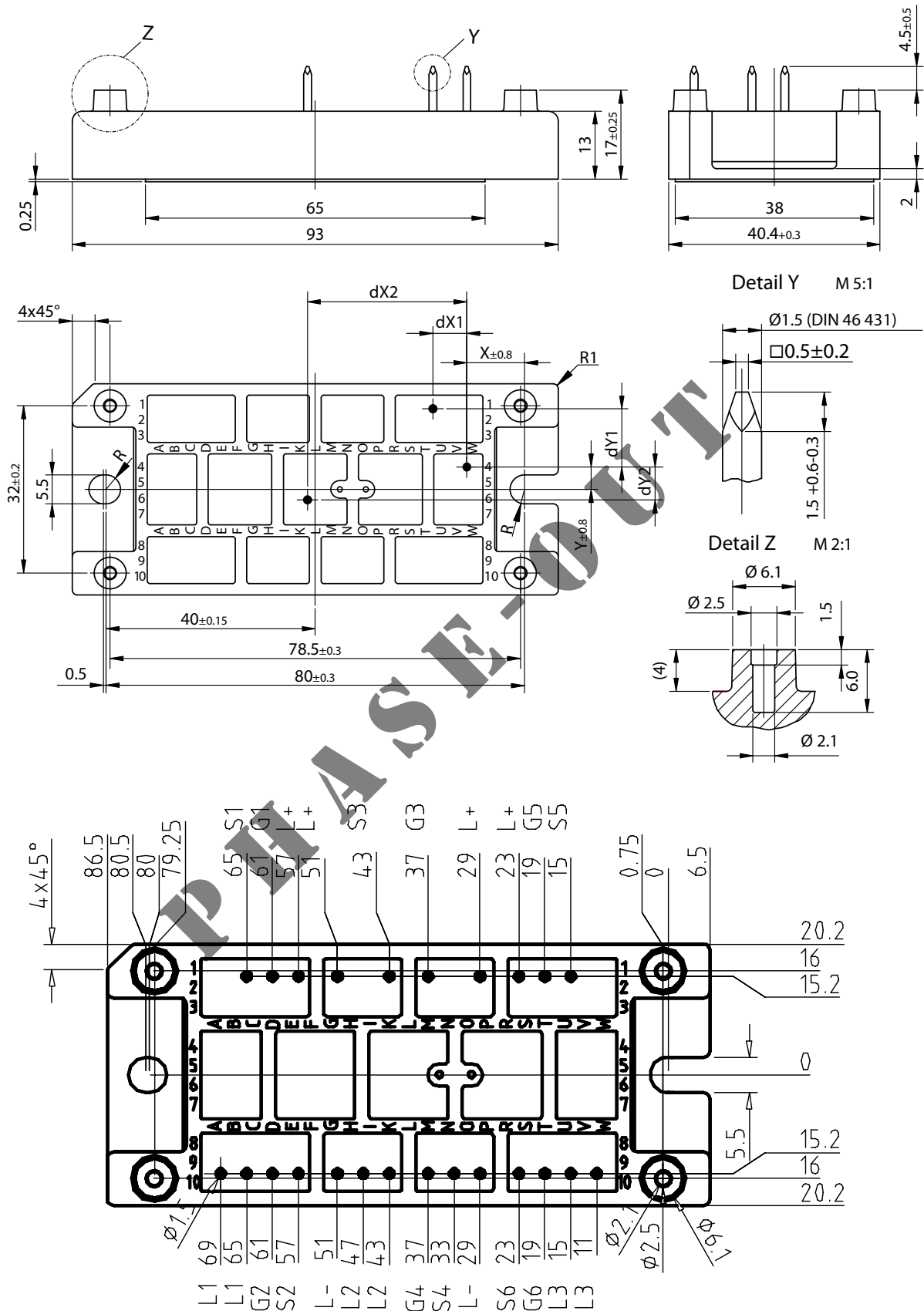

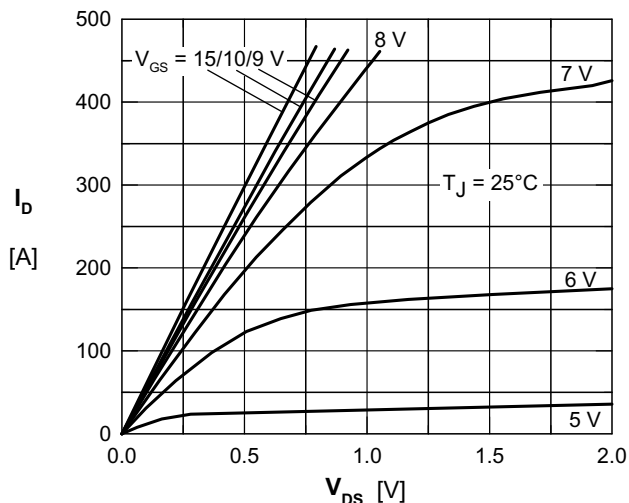

Fig. 1 Typ. Output Characteristics

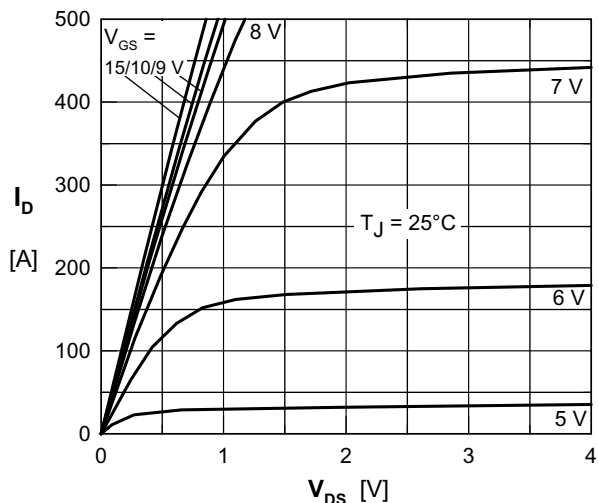

Fig. 2 Typ. Extended Output Characteristics

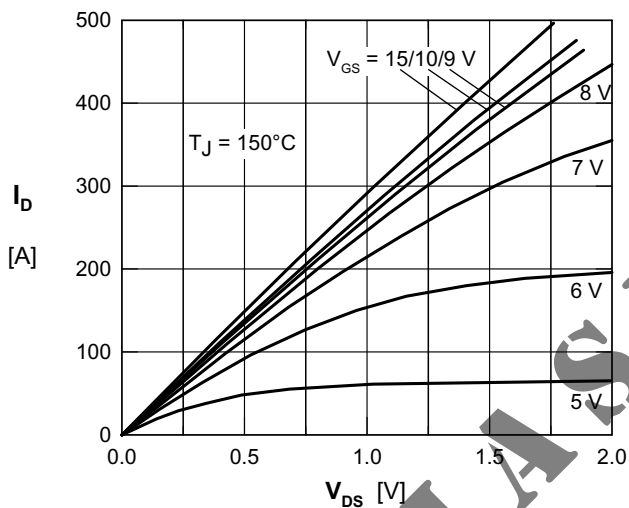

Fig. 3 Typ. Output Characteristics

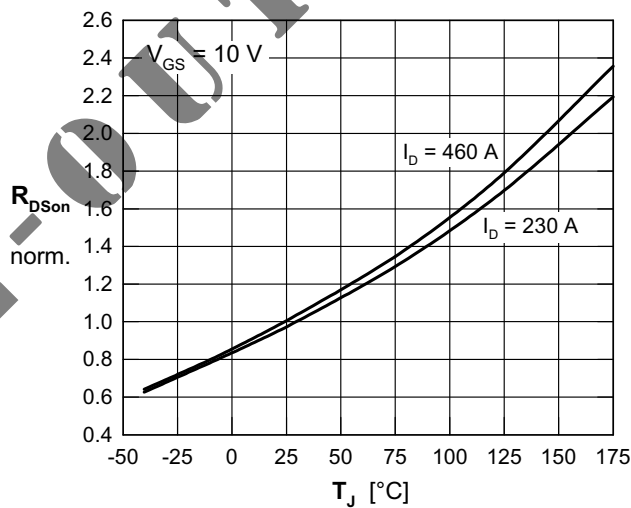

Fig. 4 $R_{DS(on)}$ Normalized to $I_D = 230$ A Value vs. Junction Temperature

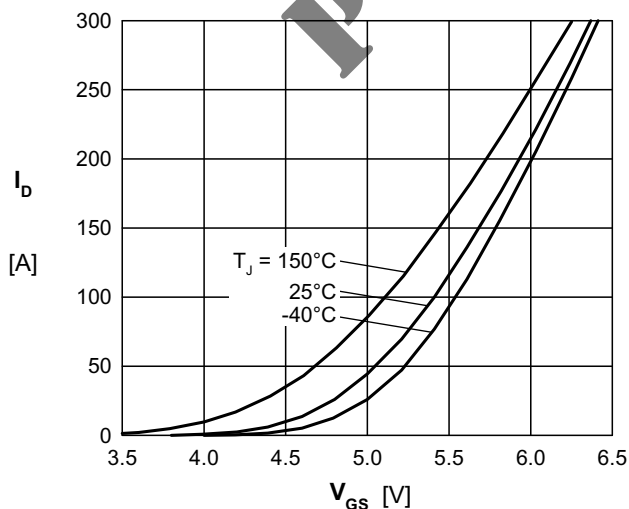

Fig. 5 Typ. Transfer Characteristics

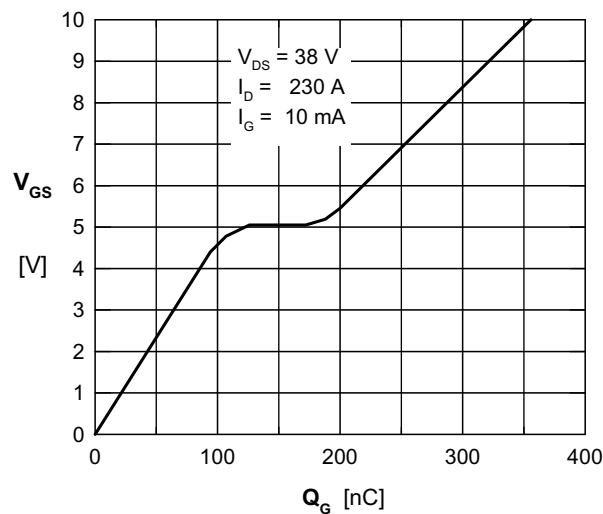

Fig. 6 Typ. Turn-on Gate Charge

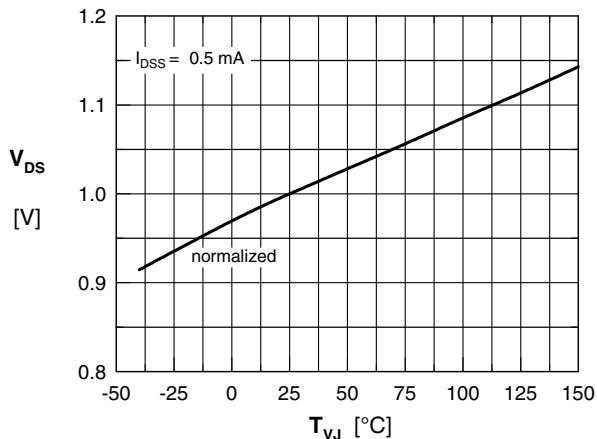

Fig. 7 Typ. Drain source breakdown voltage V_{DSS} versus junction temperature

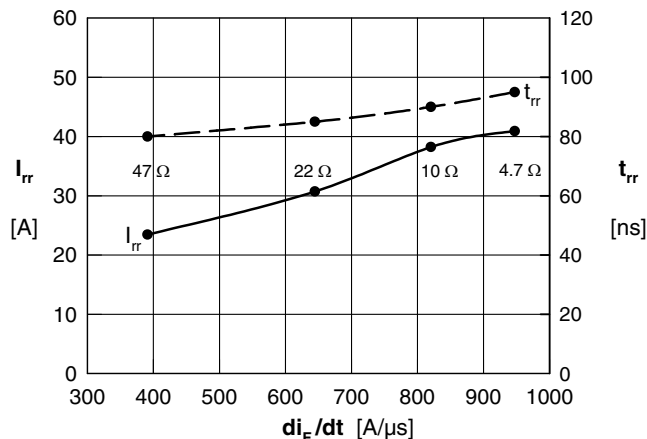

Fig. 8 Typ. Reverse recovery time and current of the body diode versus di_F/dt

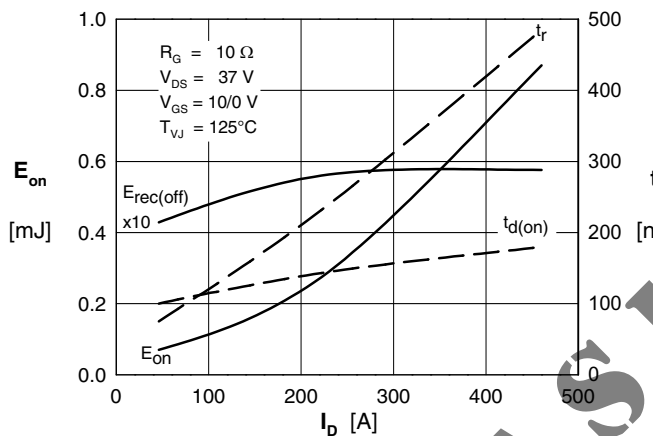

Fig. 9 Typ. turn-on energy & switching times vs. drain current, inductive switching

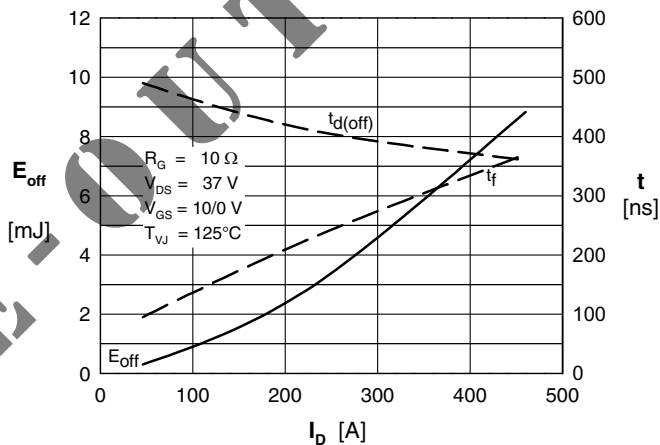

Fig. 10 Typ. turn-off energy & switching times vs. drain current, inductive switching

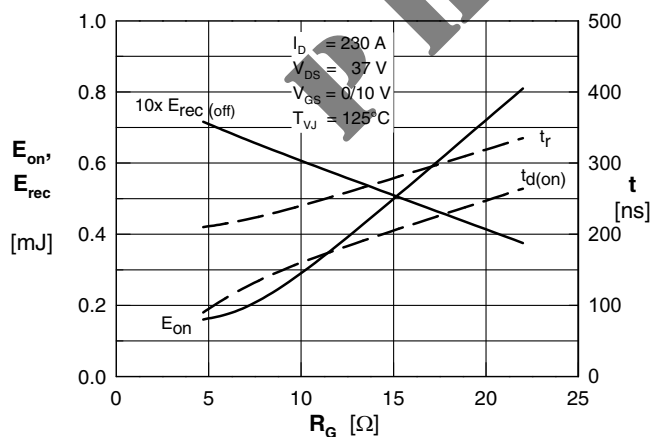

Fig. 11 Typ. turn-on energy & switching times vs. gate resistor, inductive switching

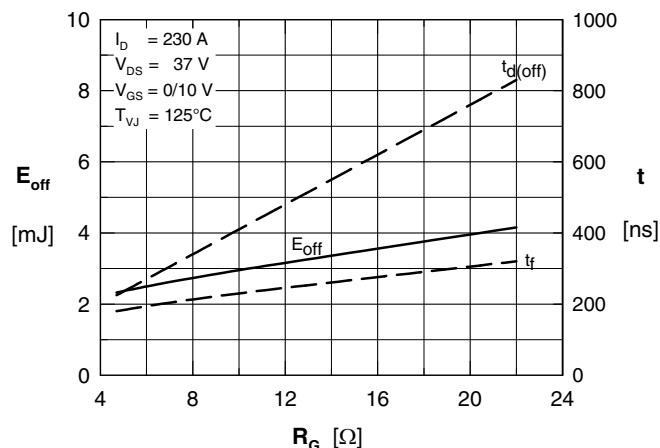

Fig. 12 Typ. turn-off energy & switching times vs. gate resistor, inductive switching

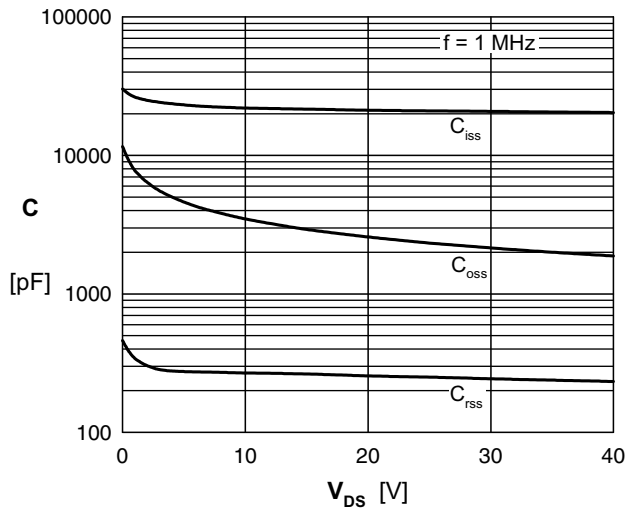

Fig. 13 Typ. Capacitances

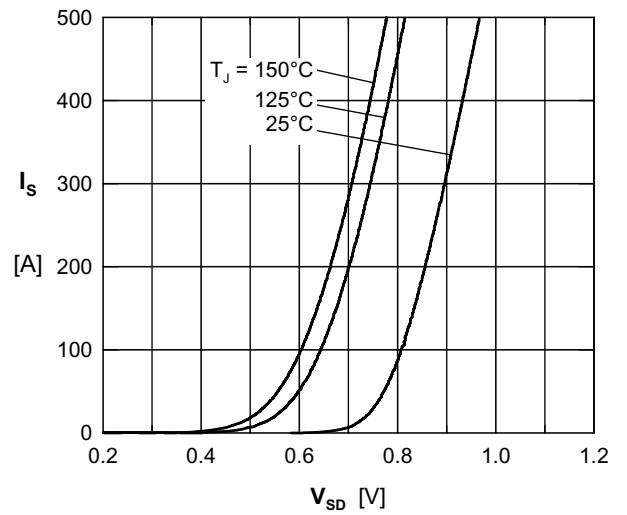

Fig. 14 Typ. Forward Voltage Drop of Intrinsic Diode

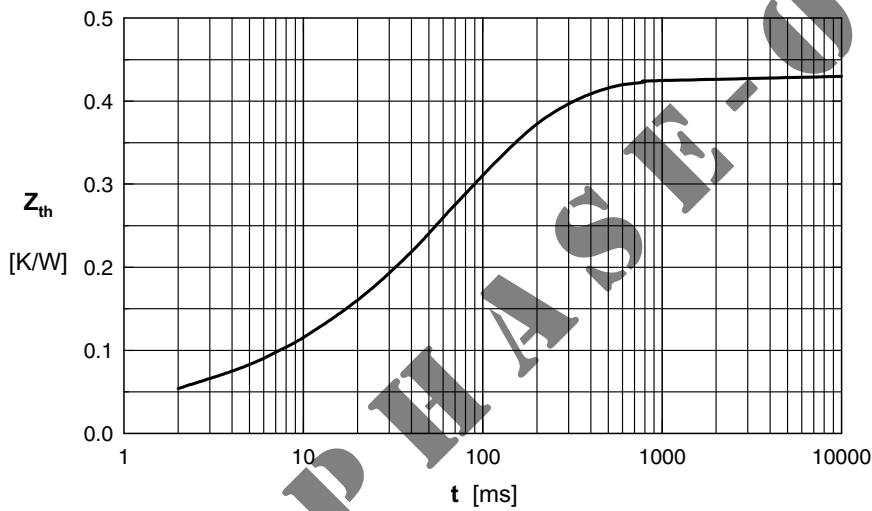

Fig. 15 Typ. Transient Thermal Resistance per MOSFET