



AP1158ADS

Active Noise Filter IC

1. General Description

AP1158ADS is active noise filter IC, which can extremely reduce the ripple noise on the power supply line. The ripple filter can be composed of few external components with low input-output voltage drop (Vdrop). Vdrop can be set by external resistance. It is packaged in SOT23-5 and suitable for small set.

2. Feature

- Low Vdrop ripple filter can be composed of few parts.
- Built-in PNP power transistor
- Output Current 150mA
- Ripple Rejection 66dB at 1kHz
- Input Voltage Range 1.8V~14.0V
- Quiescent Current 65 μ A at Iout=0mA
- Internal on/off function (High active)
- Built-in Short-circuit Protection and Thermal Shutdown Protection
- Built-in Bias Over-current Blocking Circuit
- Available to use as low Vdrop / low noise regulator.
- Small Package SOT23-5

3. Applications

- Audio Equipment (Car stereo)
- Image equipment (car navigation system)

| |
|-----------------------------|
| 4. Table of Contents |
|-----------------------------|

| | |
|--|-----------|
| 1. General Description | 1 |
| 2. Feature..... | 1 |
| 3. Applications | 1 |
| 4. Table of Contents | 2 |
| 5. Block Diagram | 3 |
| 6. Ordering Guide | 3 |
| 7. Pin Configurations and Functions..... | 4 |
| ■ Pin Configuration..... | 4 |
| ■ Functions..... | 4 |
| 8. Absolute Maximum Rating..... | 5 |
| 9. Recommended Operating Conditions | 5 |
| 10. Electrical Characteristics | 6 |
| ■ Electrical Characteristics of Ta=Tj=25°C | 6 |
| ■ Electrical Characteristics of Ta=-40°C ~85°C..... | 7 |
| 11. Description..... | 8 |
| 11.1 DC Characteristics | 8 |
| 11.2 DC Temperature Characteristics | 10 |
| 11.3 Ripple Rejection..... | 12 |
| 11.4 Output Noise | 13 |
| 11.5 Transient Response | 14 |
| 11.6 Output Capacitors..... | 15 |
| 11.7 The ability of a built-in power transistor and setting of Vdrop | 16 |
| 11.8 Application of low ripple and low noise multi output | 17 |
| 11.9 Ripple noise reduction of DC-DC converter output | 18 |
| 11.10 Reduce the motor noise..... | 18 |
| 11.11 Voltage-Power Conversion | 19 |
| 11.12 On/Off Control Switching Speed | 19 |
| 12. Definition of Term | 20 |
| 13. Test Circuit..... | 21 |
| 14. Package | 22 |
| ■ Outline Dimensions..... | 22 |
| 15. Revise History..... | 23 |
| IMPORTANT NOTICE | 24 |

5. Block Diagram

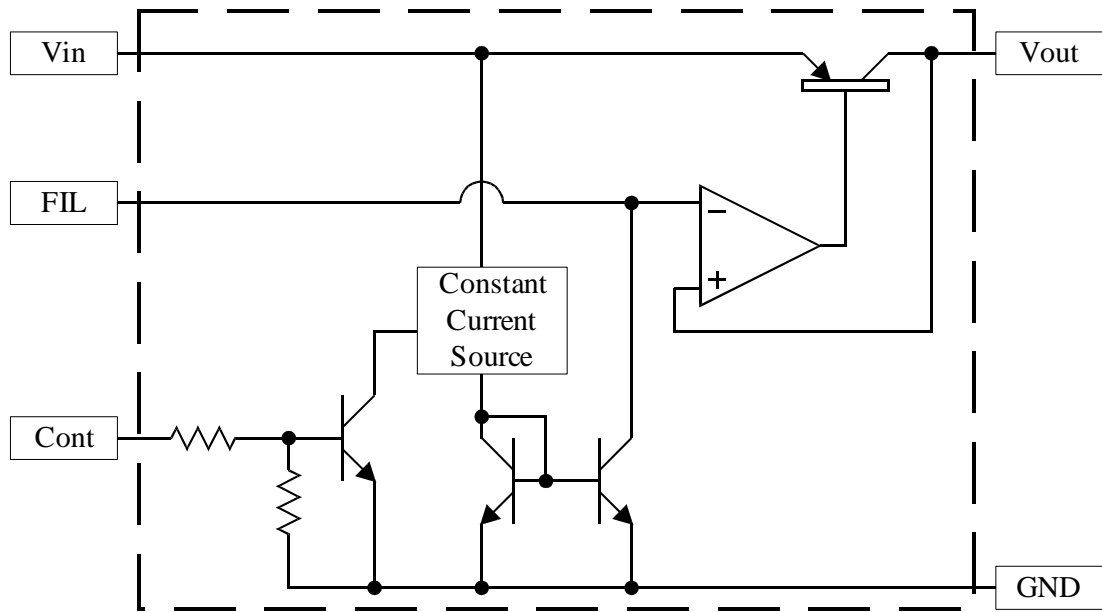

6. Ordering Guide

AP1158ADS

-40 to 85°C

SOT23-5

7. Pin Configurations and Functions

■ Pin Configuration

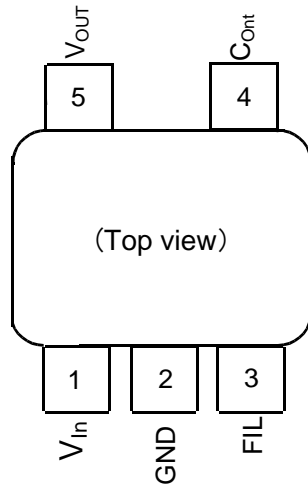

■ Functions

| Pin No. | Pin Description | Internal Equivalent Circuit | Description |
|---------|-----------------|-----------------------------|---|
| 1 | Vin | - | Input Terminal Connect a 1μF or more of capacity between the GND terminal. |
| 2 | GND | - | GND Terminal |
| 3 | FIL | | Filter Terminal Output voltage setting resistance (Rfil) is connected between Vin. Capacitor of the filter (Cfil) is connected between GND. |
| 4 | Cont | | On/Off Control Terminal VCONT > 1.8V: ON VCONT < 0.4V: OFF The pull-down resistor (400kΩ) is built-in. |
| 5 | Vout | | Output Terminal Connect a 1μF or more of capacity between the GND terminal. |

8. Absolute Maximum Rating

| Parameter | Symbol | min | max | Unit | Condition |
|-----------------------------------|-------------------|------|-----|------|-----------------------------------|
| Supply Voltage | V _{in} | -0.4 | 16 | V | |
| Reverse bias voltage | V _{rev} | -0.4 | 8 | V | V _{out} -V _{in} |
| Range of Fil terminal set voltage | V _{NP} | -0.4 | 16 | V | |
| Control terminal voltage | V _{Cont} | -0.4 | 16 | V | |
| Junction temperature | T _j | - | 150 | °C | |
| Storage Temperature Range | T _{STG} | -55 | 150 | °C | |
| Power Dissipation | P _D | - | 500 | mW | When mounted on board (Note 1) |

Note 1. -4.0mW/°C (at 25°C or more), $\theta_{JA}=250^{\circ}\text{C}/\text{W}$

WARNING: The maximum ratings are the absolute limitation values with the possibility of the IC breakage. When the operation exceeds this standard quality cannot be guaranteed.

9. Recommended Operating Conditions

| Parameter | Symbol | min | typ | max | Unit | Condition |
|-----------------------------|-----------------|-----|-----|-----|------|-----------|
| Operating Temperature Range | T _a | -40 | - | 85 | °C | |
| Operating Voltage Range | V _{OP} | 2.1 | - | 14 | V | |

10. Electrical Characteristics

■ Electrical Characteristics of Ta=Tj=25°C

The parameters with min or max values will be guaranteed at Ta=Tj=25°C.

(Vin=2.5V, Vcont=2V, Rfil=390kΩ, Cin=1μF, Cfil=4.7μF, Cout=1μF, unless otherwise specified.)

| Parameter | Symbol | Condition | min | typ | max | Unit |
|---|---------------------|--|-----|-----|------|------------|
| Quiescent Current | Iin | Iout = 0mA | - | 65 | 100 | μA |
| Standby Current | Istandby | Vin = 8V, Vcont = 0V | - | 0.1 | 100 | nA |
| Output Current | Iout | | - | - | 150 | mA |
| Maximum Output Current (Note 2) (Note 5) | Iout _{MAX} | Vout = Vouttyp×0.9 | - | 360 | - | mA |
| Load Regulation | LoaReg | Iout = 1 ~ 100mA | - | 6 | 20 | mV |
| Reverse Bias Current | Irev | Vin= 0V, Vcont= 0V, Vout= 8V | - | 0.1 | 100 | nA |
| FIL terminal Sink current | Isink | FIL terminal voltage = Vin - 0.3V | 0.5 | 0.6 | 0.72 | μA |
| Error Amp Input Offset Voltage | Verror | Iout = 30mA | 20 | 40 | 60 | mV |
| Control Terminal | | | | | | |
| Control Terminal Current | Icont | Vcont = 2.0V | - | 4.5 | 8.0 | μA |
| Control Terminal Voltage | Vcont | Vout ON state | 1.8 | - | - | V |
| | | Vout OFF state | - | - | 0.4 | V |
| Ripple Rejection (Note 3) | R.R. | Iout = 30mA Ripple Noise=200mVp-p(@1kHz) | 55 | 66 | - | dB |
| Output Noise (Note 4) (Note 5) | - | at 1kHz | - | 60 | - | nV/ √Hz |

Note 2. The maximum output current is limited by power dissipation.

Note 3. Ripple rejection is dependent on the characteristics of the input and output voltage difference and the capacitor, which is set by the resistance. Consider the variation of the variation and the capacitance value of the resistance value. Value of Rfil and Cfil, please change according to the conditions required by the set. The above value is an example of the measurement.

Note 4. This is the output noise without ripple noise. The IC itself generates the noise because it is semiconductor integrated circuit.

Note 5. Items of typical value only show reference values.

■Electrical Characteristics of Ta=-40°C ~85°C

The parameters with min or max values will be guaranteed at Ta=Tj=-40 ~ 85°C.

(Vin=2.5V, Vcont=2V, Rfil=390kΩ, Cin=1μF, Cfil=4.7μF, Cout=1μF, unless otherwise specified.)

| Parameter | Symbol | Condition | min | typ | max | Unit |
|---|---------------------|---|-----|-----|------|------------|
| Quiescent Current | Iin | Iout = 0mA | - | 65 | 120 | μA |
| Standby Current | Istandby | Vin = 8V, Vcont = 0V | - | 0.1 | 500 | nA |
| Output Current | Iout | | - | 360 | - | mA |
| Maximum Output Current (Note 6) (Note 9) | Iout _{MAX} | Vout = Vouttyp×0.9 | - | - | 150 | mA |
| Load Regulation | LoaReg | Iout = 1 ~ 100mA | - | 6 | 55 | mV |
| Reverse Bias Current | Irev | Vin = 0V, Vcont=0V, Vout=8V | - | 0.1 | 2000 | nA |
| FIL terminal Sink current | Isink | FIL terminal voltage = Vin - 0.3V | 0.4 | 0.6 | 0.84 | μA |
| Error Amp Input Offset Voltage | Verror | Iout = 30mA | -30 | 40 | 110 | mV |
| Control Terminal | | | | | | |
| Control Terminal Current | Icont | Vcont = 2.0V | - | 4.5 | 10.0 | μA |
| Control Terminal Voltage | Vcont | Vout ON state | 1.8 | - | - | V |
| | | Vout OFF state | - | - | 0.4 | V |
| Ripple Rejection (Note 7) | R.R. | Vin = 2.5V, Rfil = 390kΩ Iout = 30mA, Cfil = 4.7μF Ripple Noise=200mVp-p(@1kHz) | 40 | 66 | - | dB |
| Output Noise (Note 8)(Note 9) | - | at 1kHz (Reference value) | - | 60 | - | nV/ √Hz |

Note 6. The maximum output current is limited by power dissipation.

Note 7. Ripple rejection is dependent on the characteristics of the input and output voltage difference and the capacitor, which is set by the resistance. Consider the variation of the variation and the capacitance value of the resistance value. Value of Rfil and Cfil, please change according to the conditions required by the set. The above value is an example of the measurement.

Note 8. This is the output noise without ripple noise. The IC itself generates the noise because it is semiconductor integrated circuit.

Note 9. Items of typical value only show reference values.

11. Description

11.1 DC Characteristics

Measurement conditions (Otherwise specified) :

$V_{in}=2.5V$, $V_{cont}=2V$, $R_{fil}=390k\Omega$, $C_{in}=1\mu F$, $C_{fil}=4.7\mu F$, $C_{out}=1\mu F$, $I_{out}=5mA$

■ Filter Terminal Sink Current

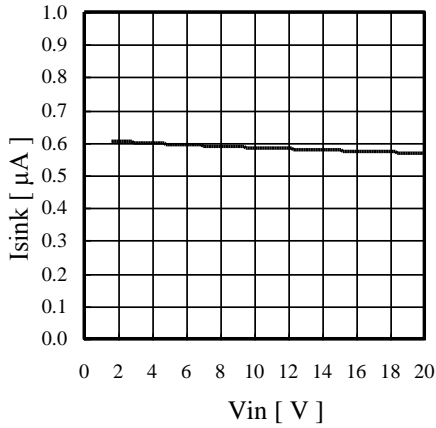

■ Error Amp. off-set Voltage

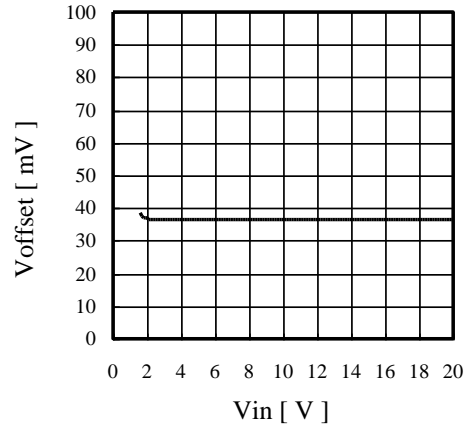

■ Vdrop

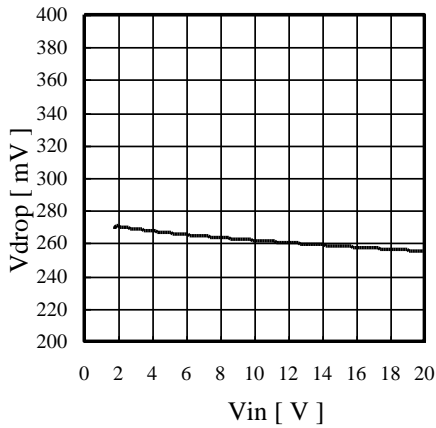

■ Quiescent Current (Iout=0mA)

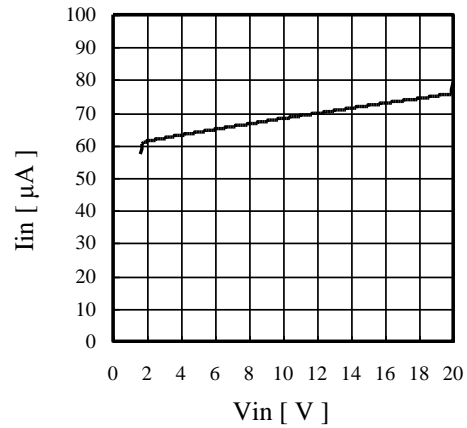

■ Load Regulation

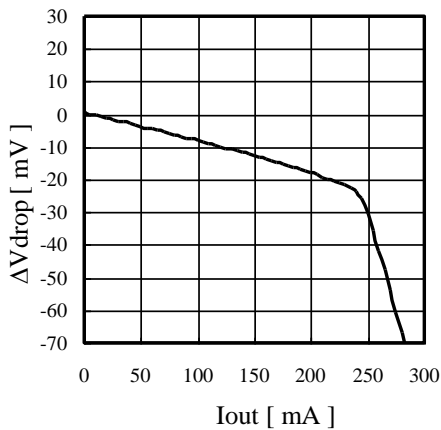

■ GND Pin Current

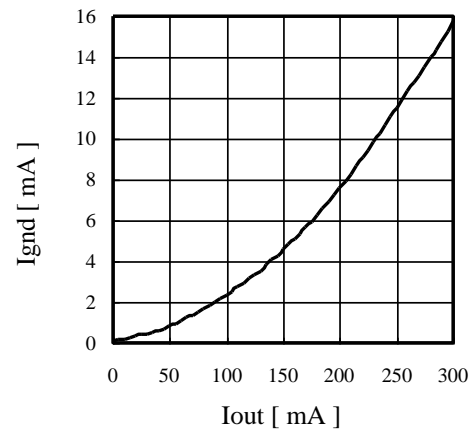

■ Vout ON-Point

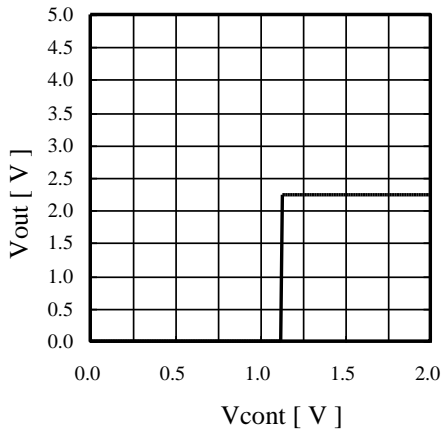

■ Cont Current vs Cont Voltage

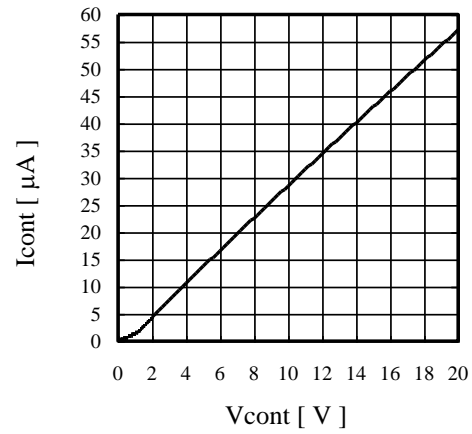

■ Standby Current

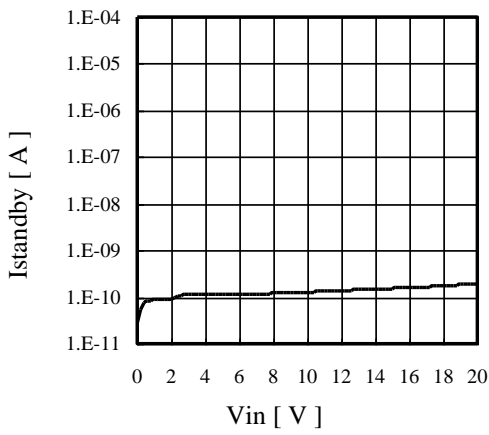

■ Reverse bias Current

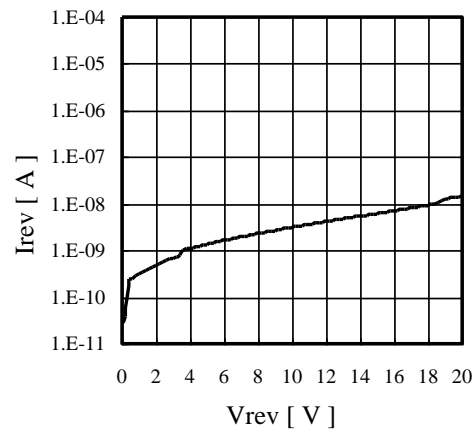

■ Maximum Output Current

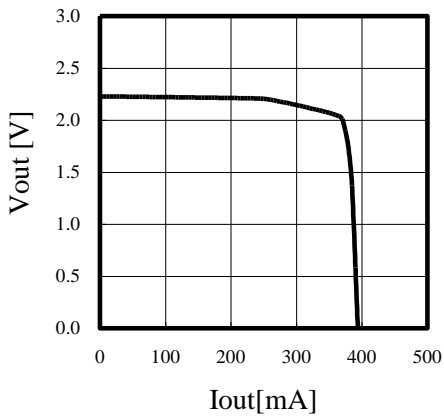

■ Maximum Output Current (Vin)

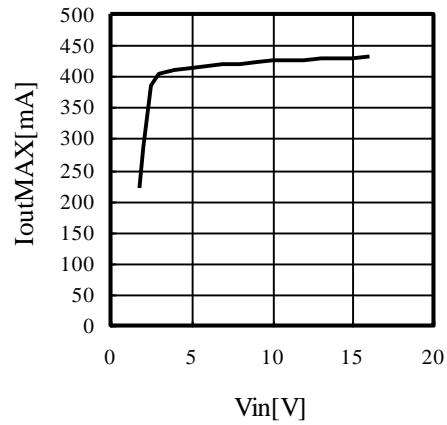

11.2 DC Temperature Characteristics

Measurement conditions (Otherwise specified) :

$V_{in}=2.5V$, $V_{cont}=2V$, $R_{fil}=390k\Omega$, $C_{in}=1\mu F$, $C_{fil}=4.7\mu F$, $C_{out}=1\mu F$, $I_{out}=5mA$

■ Filter Terminal Sink Current

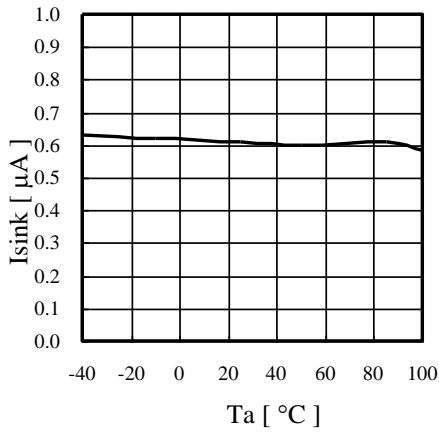

■ Error Amp. off-set Voltage

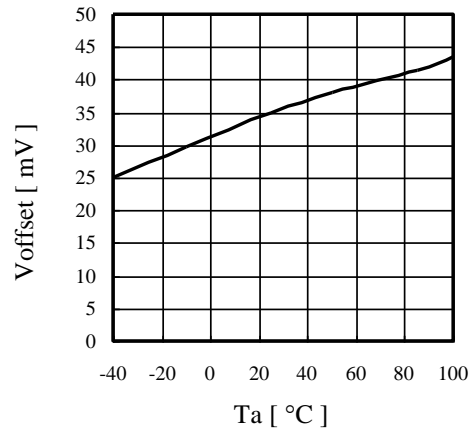

■ Vdrop

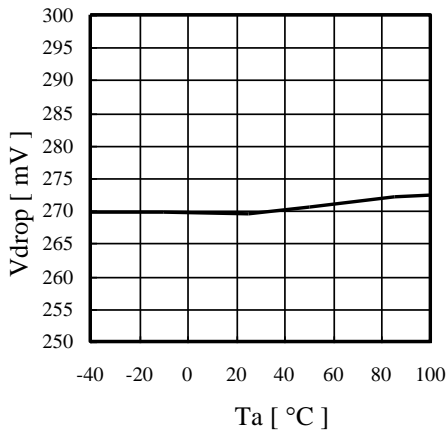

■ Quiescent Current ($I_{out}=0mA$)

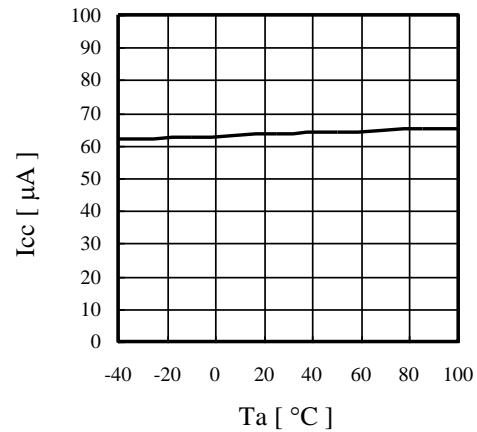

■ Load Regulation

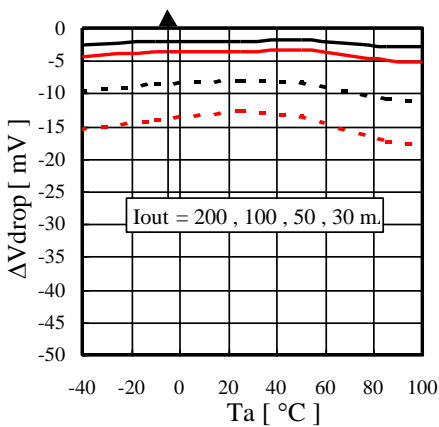

■ GND Pin Current

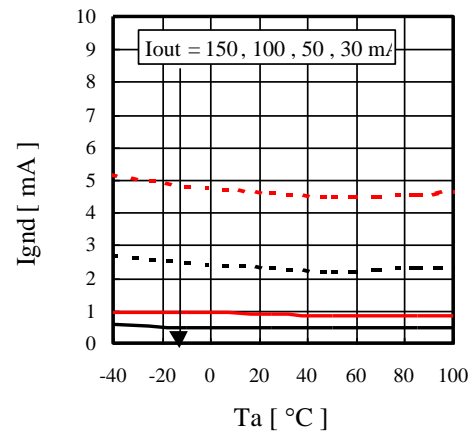

■ Vout ON-Point

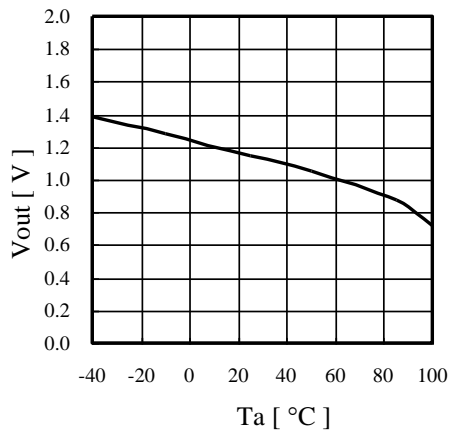

■ Cont Current vs Cont Voltage

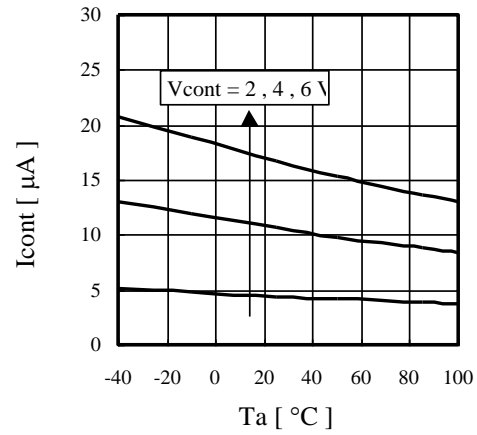

■ Maximum Output Current

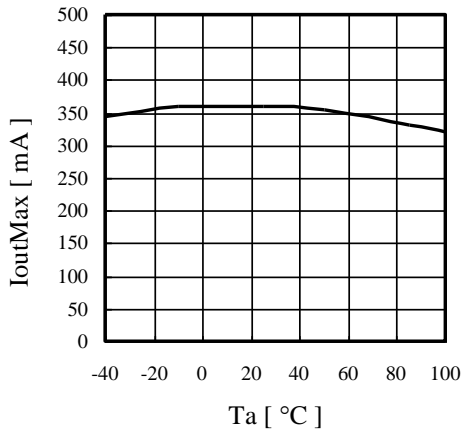

11.3 Ripple Rejection

Measurement condition (Otherwise specified)

$V_{in}=2.5V$, $V_{cont}=2V$, Ripple Noise=200mVp-p, $R_{fil}=390k\Omega$, $C_{in}=1\mu F$, $C_{fil}=4.7\mu F$, $C_{out}=1\mu F$, $I_{out}=30mA$

RR [dB]

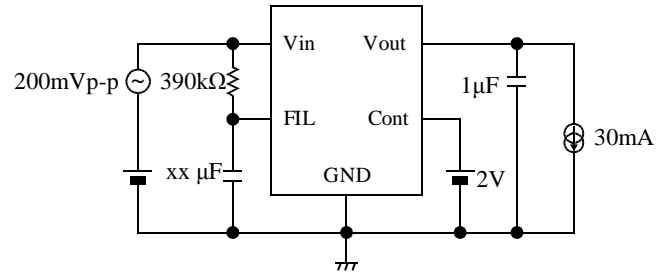
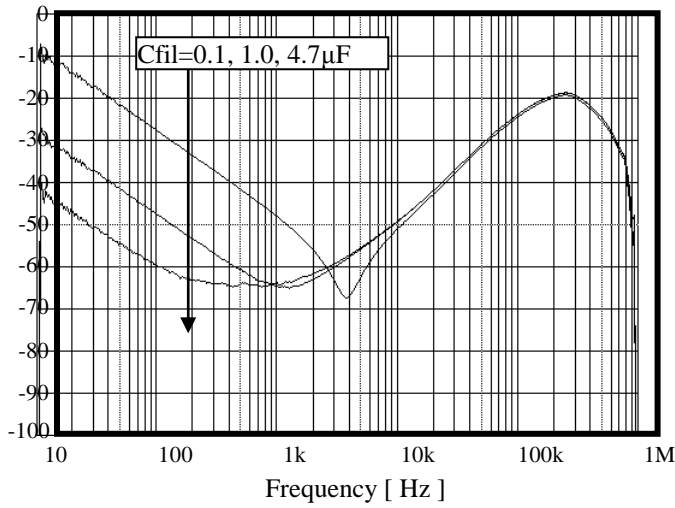

■ RR vs Ripple Noise (Freq = 1kHz)

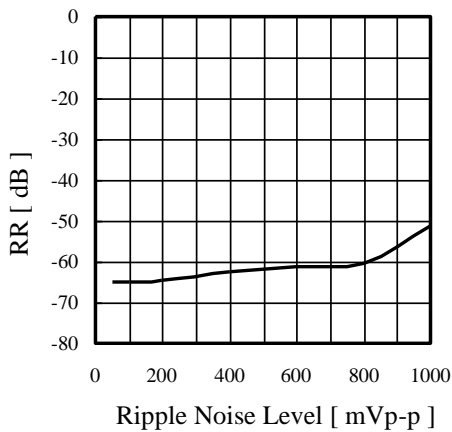

■ RR vs Iout (Freq = 1kHz)

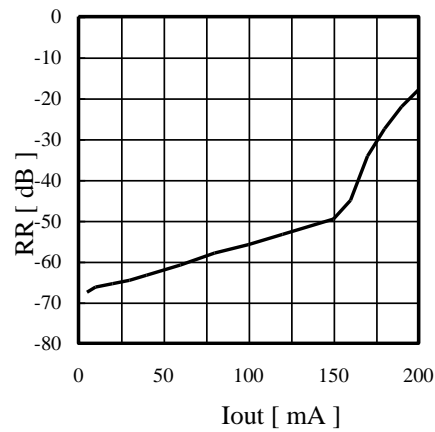

■ RR vs Vin

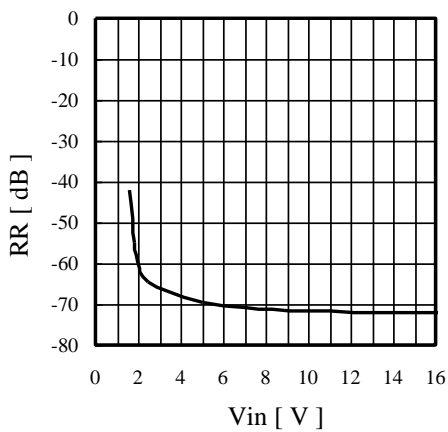

11.4 Output Noise

Measurement condition (Otherwise specified)

$V_{in}=2.5V$, $V_{cont}=2V$, $R_{fil}=390k\Omega$, $C_{in}=1\mu F$, $C_{fil}=4.7\mu F$, $C_{out}=1\mu F$, $I_{out}=30mA$

■ Output Noise vs Iout

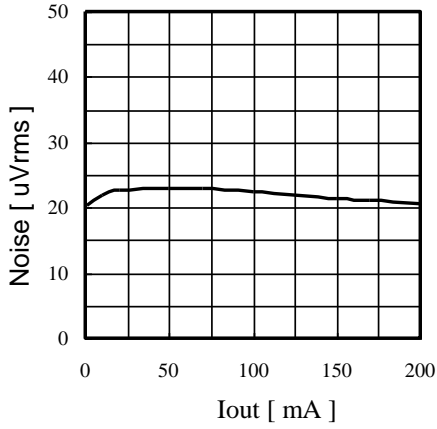

■ Output Noise vs Vin

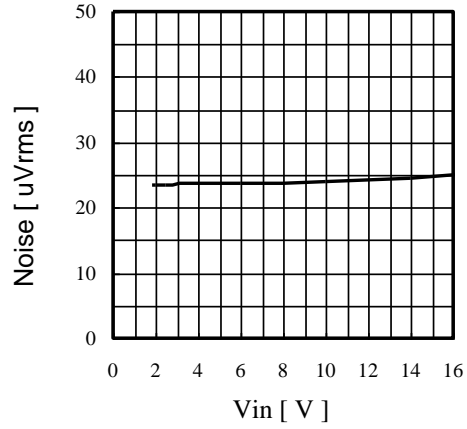

■ Output Noise Density

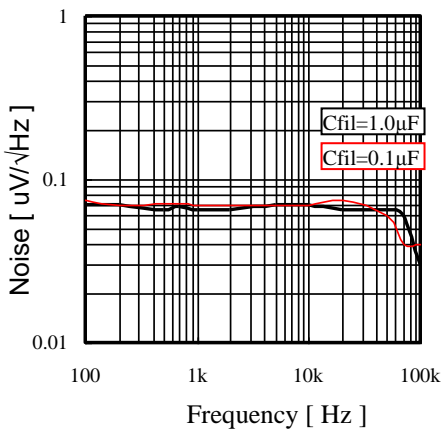

11.5 Transient Response

Measurement condition (Otherwise specified)

$V_{in}=2.5V$, $V_{cont}=2V$, $R_{fil}=390k\Omega$, $C_{in}=1\mu F$, $C_{fil}=4.7\mu F$, $C_{out}=1\mu F$, $I_{out}=30mA$

■ On/Off control transient response

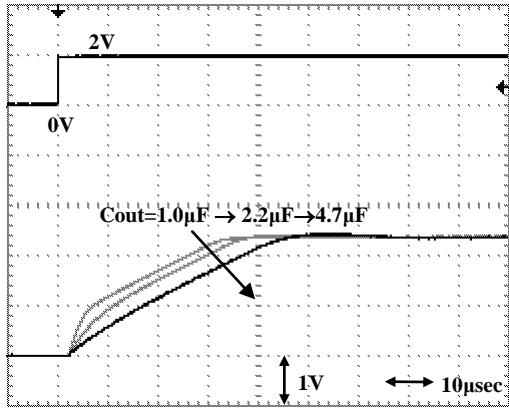

■ Input transient response

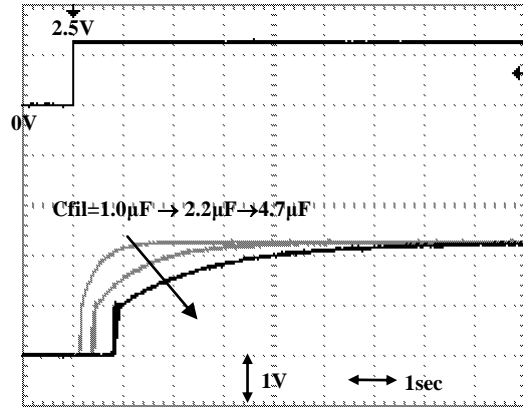

■ Load transient response

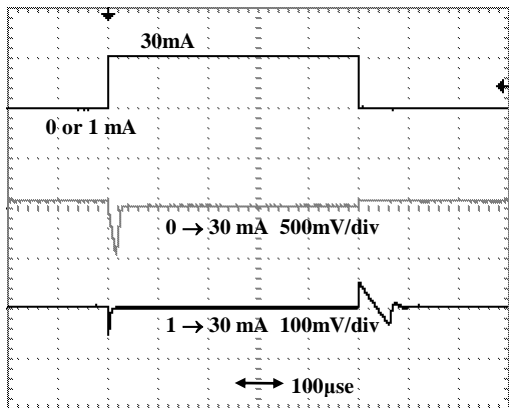

11.6 Output Capacitors

AP1158ADS requires input and output capacitors in order to maintain the loop stability. AP1158ADS may oscillate if there is no input/output capacitor. Please select the output capacitor whose equivalent series resistance (ESR) is in the stable operation area. Please refer to the following graph and select the capacitor of the best characteristics. Either ceramic or tantalum capacitor can be used for output terminal. If the capacitor of 0.22 μ F or more and the equivalent series resistance is 6 Ω or less is connected to the output pin, the IC provides stable operation. The capacitance and the equivalent series resistance have tolerance that depends on the product and the manufacturer. Generally, a ceramic capacitor has both temperature characteristic and voltage characteristic. Please consider both characteristics when selecting the part. A recommended value of the application is 1.0 μ F or more.

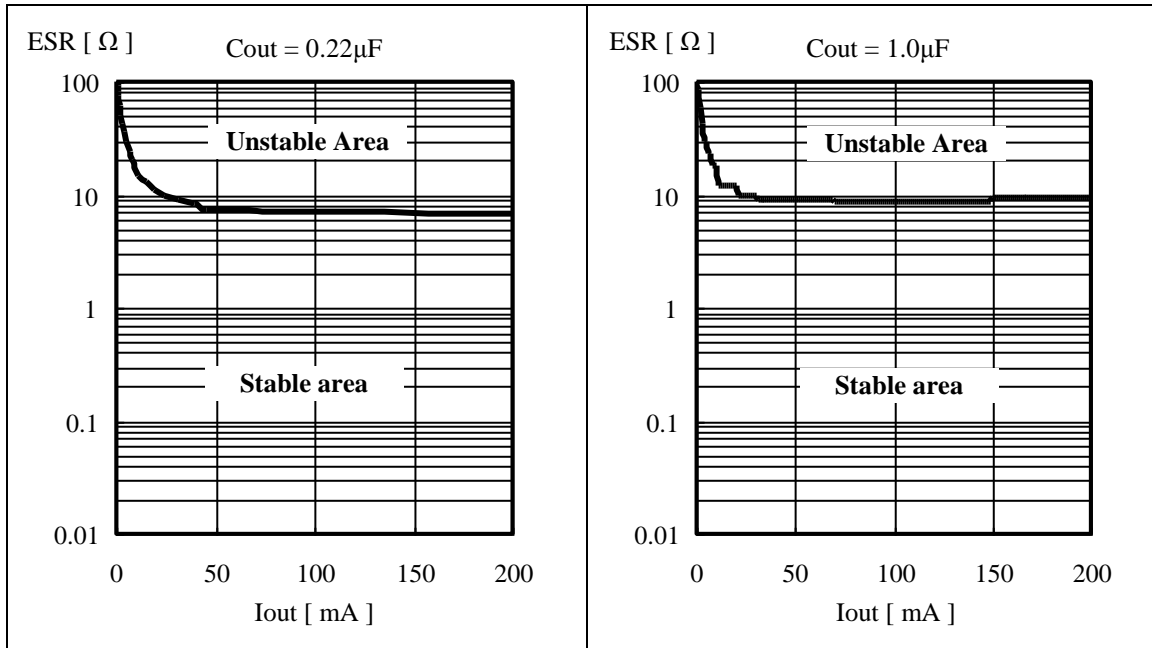

Figure 1. Unstable area

11.7 The ability of a built-in power transistor and setting of Vdrop

Figure 2 shows the ability of a built-in power transistor. When Vdrop of AP1158ADS is set to 300mV, it can supply an output current of 250mA at the maximum. But this is a current value when the input voltage does not have the ripple noise. When the input voltage has the ripple noise, it cannot supply the output current value more. When the input voltage has the ripple noise shown in Figure 3, it can supply an output current of only 150mA at the maximum.

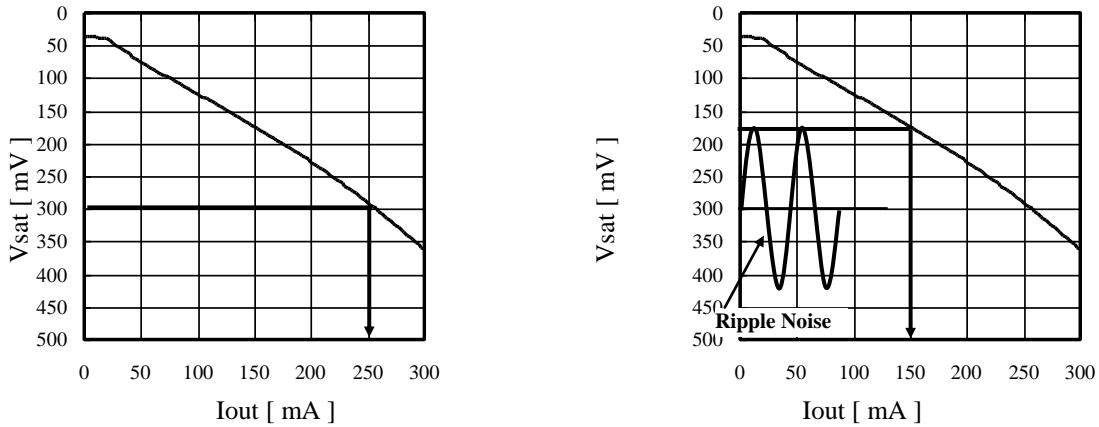

Figure 2. (Left) The ability of a built-in power transistor
(Right) When the input voltage has the ripple noise

If using output current is small, Vdrop can be reduced by lowering the value of Rfil. Figure 3 (Left) shows relations of Rfil and Vdrop. When Vdrop is reduced, load regulation deteriorates as shown in Figure 3(Right).

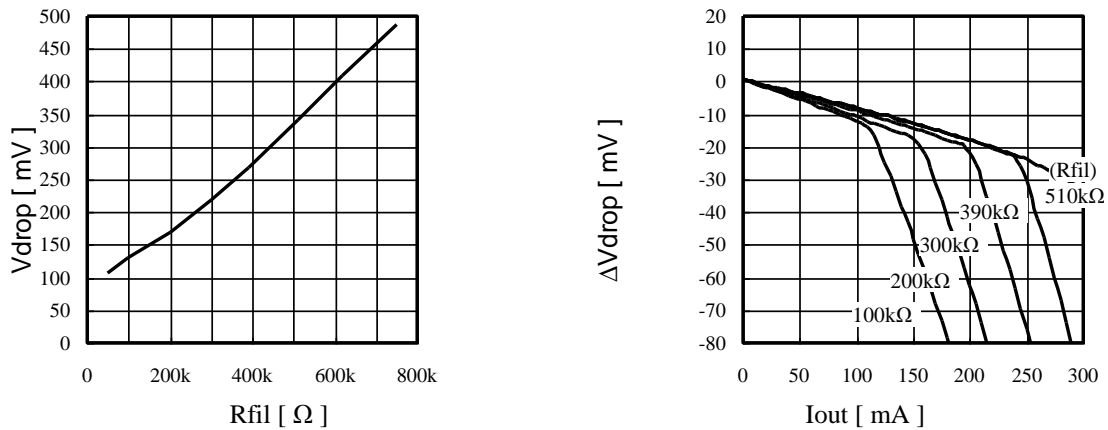

Figure 3. (Left) Vdrop vs Rfil (Iout=5mA)
(Right) Load Regulation (Rfil)

11.8 Application of low ripple and low noise multi output

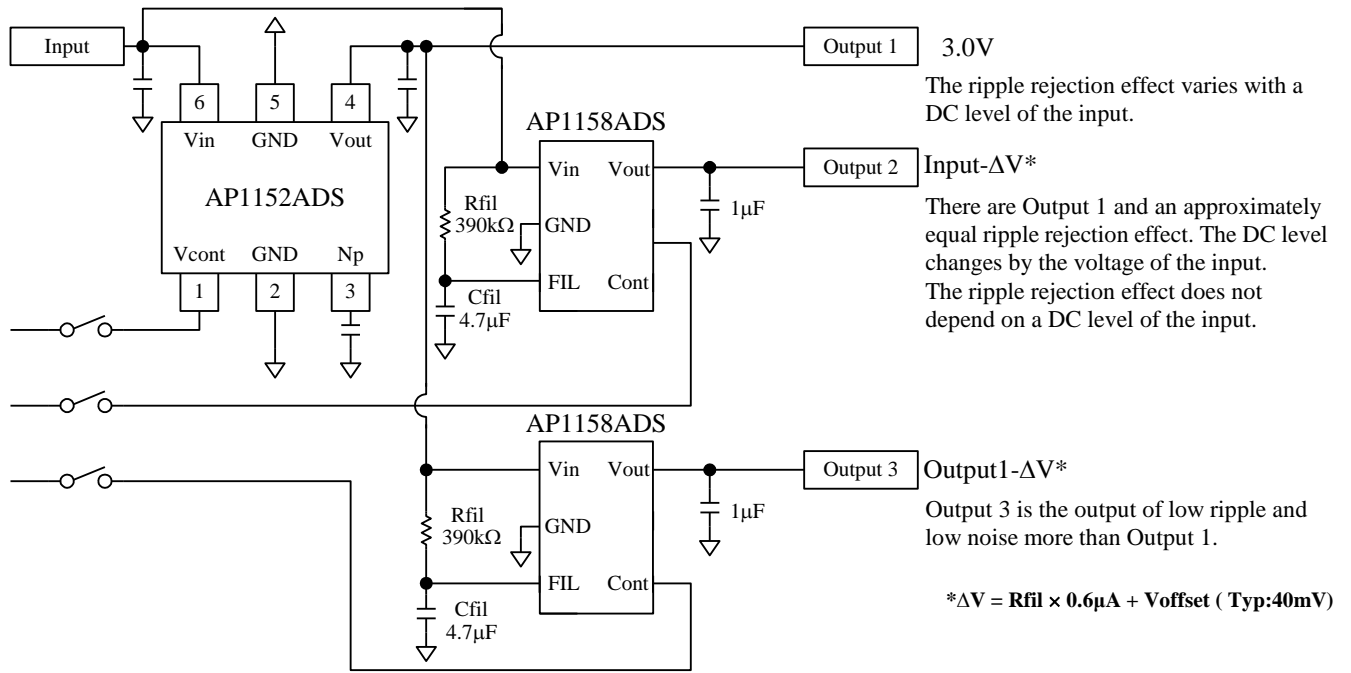

Figure 4. Low Ripple and Low Noise System Output

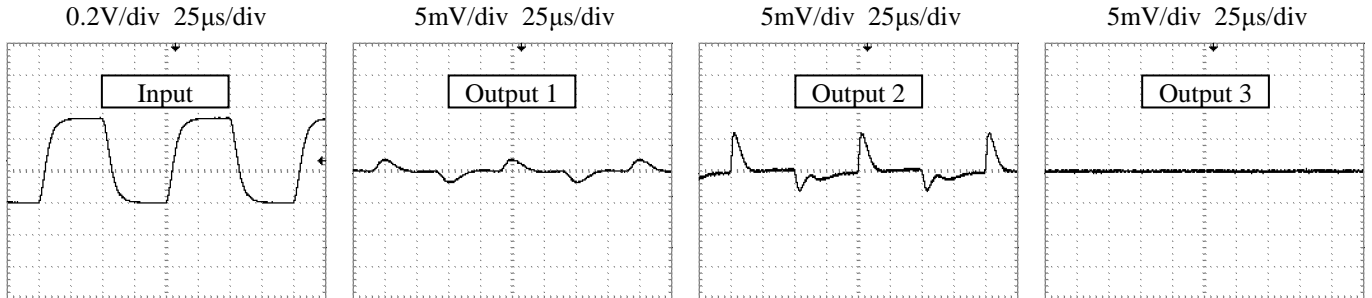

Figure 5. Input Voltage : 3.55V + Ripple Noise

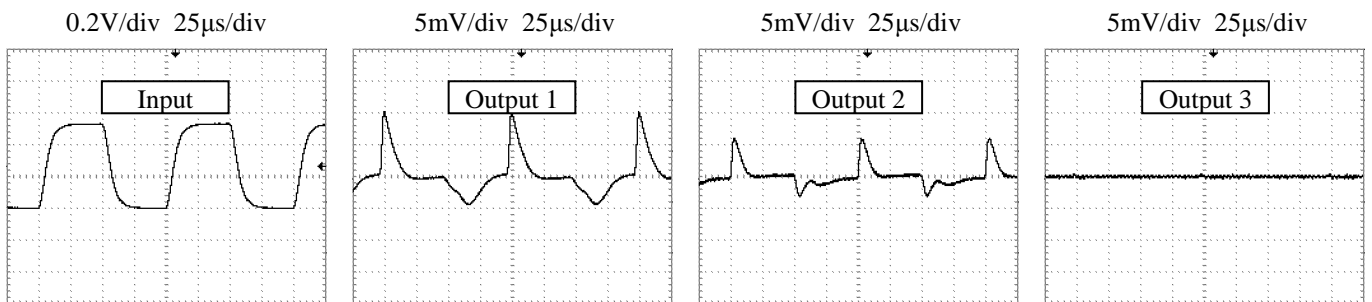

Figure 6. Input Voltage : 3.35V + Ripple Noise

11.9 Ripple noise reduction of DC-DC converter output

Ripple noise of the DC-DC converter is removed by connecting AP1158ADS at the output of the DC-DC converter.

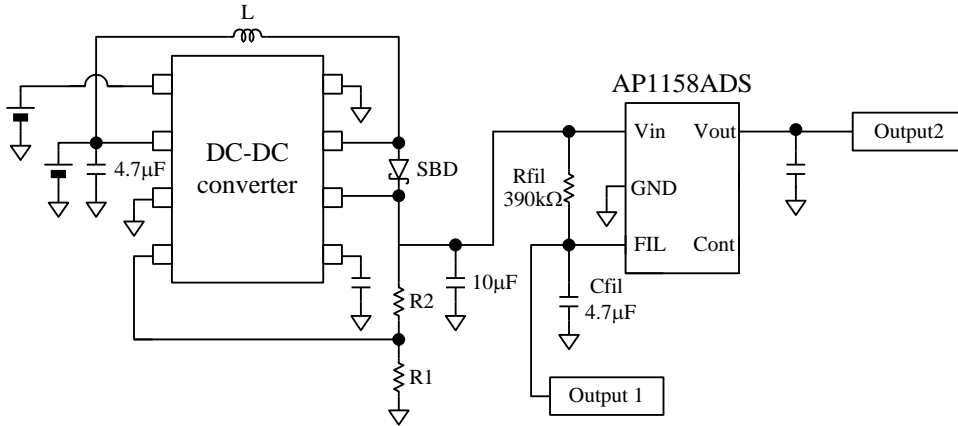

Figure 7. Ripple noise removal of DC-DC converter output

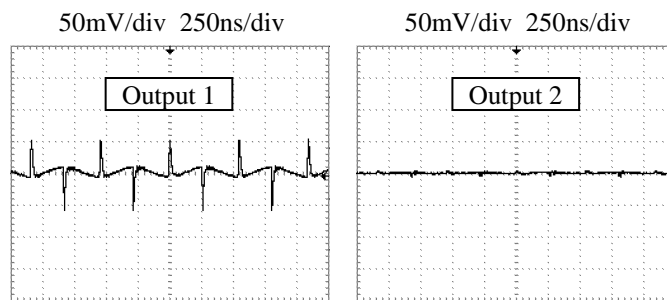

Figure 8. Output ripple noise

11.10 Reduce the motor noise

When high voltage from the battery without motor noise is necessary, refer to [Figure 9](#).

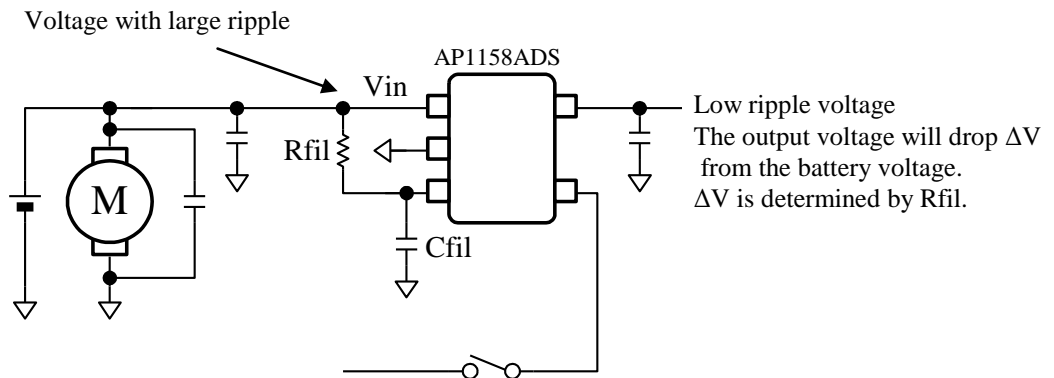

Figure 9. Reduce the motor noise

11.11 Voltage-Power Conversion

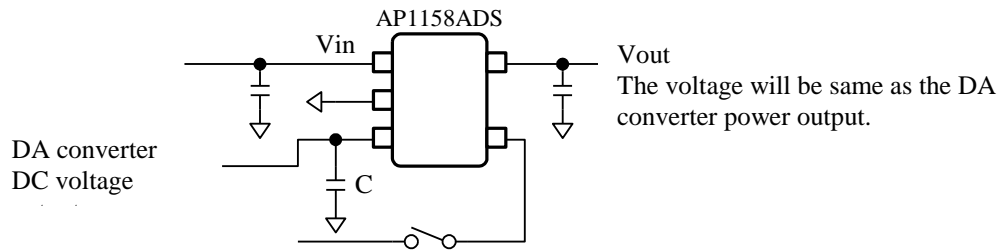

Figure 10. Voltage-Power conversion

11.12 On/Off Control Switching Speed

Vout rises at high-speed when Cont pin is controlled with the input voltage is added to Vin pin. It takes long time to charge Cfil when Vin is controlled directly. Please reduce the time constant of the filter to make the rise time early. Therefore, it is necessary to reduce the Cfil. Cfil=4.7μF is a standard but can be changed. Please choose the best Cfil according to the ripple noise level and the frequency. Moreover, the rise time becomes earlier by connecting diode parallel with Rfil. “Vf × 1/2 of the diode” is a standard of the Vdrop.

[Charge time]

Only at Rfil=390kΩ, Cfil=4.7μF

$$t = 5 \times C_{fil} \times R_{fil} = 5 \times 390 \times 10^3 \times 470 \times 10^{-6} = 9.25 \text{ sec}$$



Figure 11. SW switching circuit

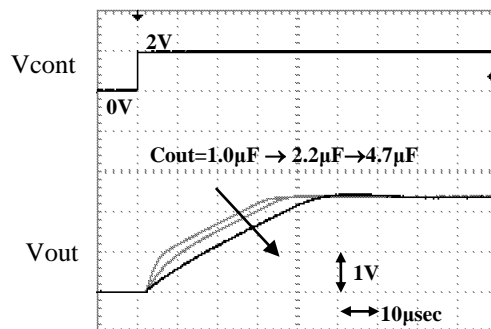

Figure 12. On / off speed when it is changing the output side capacitor

12. Definition of Term

• Sink Current of FIL Terminal

The sink current of the FIL terminal is 0.6μA(typ). The Vdrop is calculated as follows.

$$V_{drop} = \{(\text{Sink Current}) \times (R_{fil})\} + (\text{Offset voltage})$$

Ripple rejection ratio largely depends on this value.

$$\text{Standard value: } R_{fil} = 390\text{k}\Omega \text{ (} V_{drop} = 270\text{mV) , } V_{drop} \text{ (mV)} = R_{fil} \text{ (k}\Omega) \times 0.6\mu\text{A} + 40\text{mV}$$

•Input-output voltage drop (Vdrop)

Vdrop is set by Rfil. It is necessary to set Vdrop large when there is a margin between the input voltage and output voltage, or the ripple noise is large. Please fix the Vdrop according to ripple noise, maximum output current and operating voltage.

• On / Off Control

Control terminal is active “H”. By connecting the terminal to GND, input current becomes almost zero. (Operation stops) If the load current is 0 (the load impedance is very high), the Cout electric charge remains. Therefore, if the ripple filter IC is switched at the same time with the load, quick response application will be available. In case not using on/off control, please connect this terminal to Vin. The control current decreases when resistance is connected in series. Series resistance around 300kΩ and pull-down resistor are built in this terminal. Therefore, when series resistance is connected, the control current will decrease though the control voltage may swerves to high side. There is no hysteresis in this terminal. Please apply “H” or “L” surely otherwise noise level will increase.

•Ripple Rejection Ratio (R.R.)

Ripple rejection is the ability of the IC to attenuate the ripple content of the input voltage at the output. It is specified with the input voltage with AC voltage (condition: 1) overlapped with DC voltage (condition: 2)

$$\text{Condition1: } 200\text{mV}_{p-p}, f=1\text{kHz}, \text{Condition2: } V_{in}=2.5\text{V}$$

The measurement condition is as follows.

Cin=0.1μF, Cout=1μF, Cfil=4.7μF, Rfil=390kΩ(Vdrop=270mV), Vin: DC=2.5V, AC=200mVp-p (at f=1kHz)

It is necessary to enlarge Rfil and Cfil to improve the ripple rejection ratio at the low frequency range. The ripple rejection depends on the set Vdrop and the characteristics of the capacitor. Please consider the tolerance of resistor and capacitor. Please adjust the value of Rfil(=390kΩ) and Cfil(=4.7μF) depends on application.

• On / Off speed

Vout rises at high-speed when Cont pin is controlled with the input voltage is added to Vin pin. Operation will be very slow when the power supply is started by other control functions. When the time constant of the filter is small, Vout stands up quickly. By connecting diode in parallel with Rfil, Vout also stands up quickly.

•Maximum Output Current (Iout MAX)

The rated output current is specified under the condition when the output voltage drops 10% the value specified with Iout=5mA. The input voltage is set at VoutTYP+1V and the current is pulsed to minimize temperature effect.

•Reverse Bias Current (Irev)

The current flows from the Vout pin to the IC when Vin=0V, Vcont=0V and Vout=8V.

•Quiescent Current (Iqnd)

The current flows to GND terminal. It is the difference between the input current and the output current.

13. Test Circuit

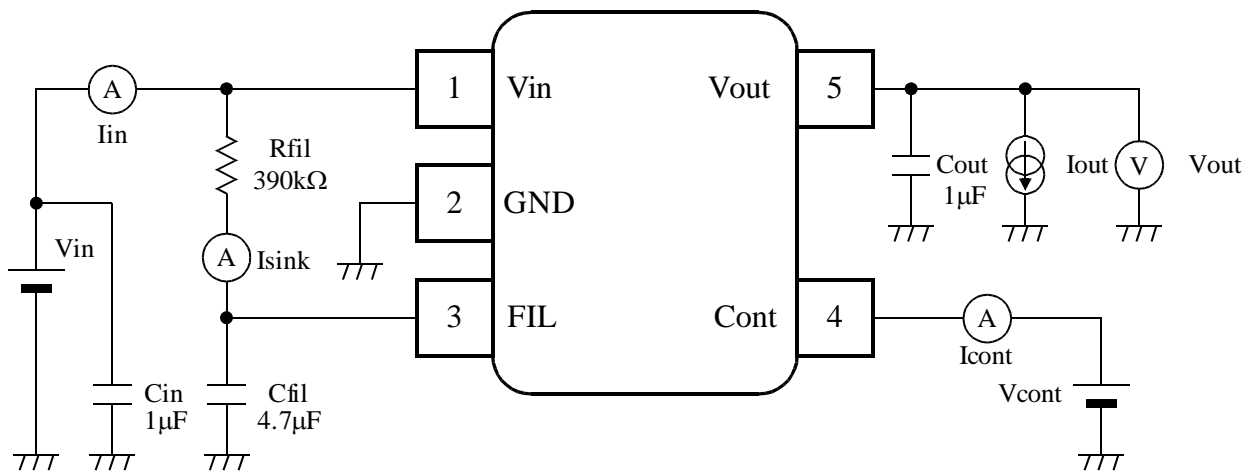
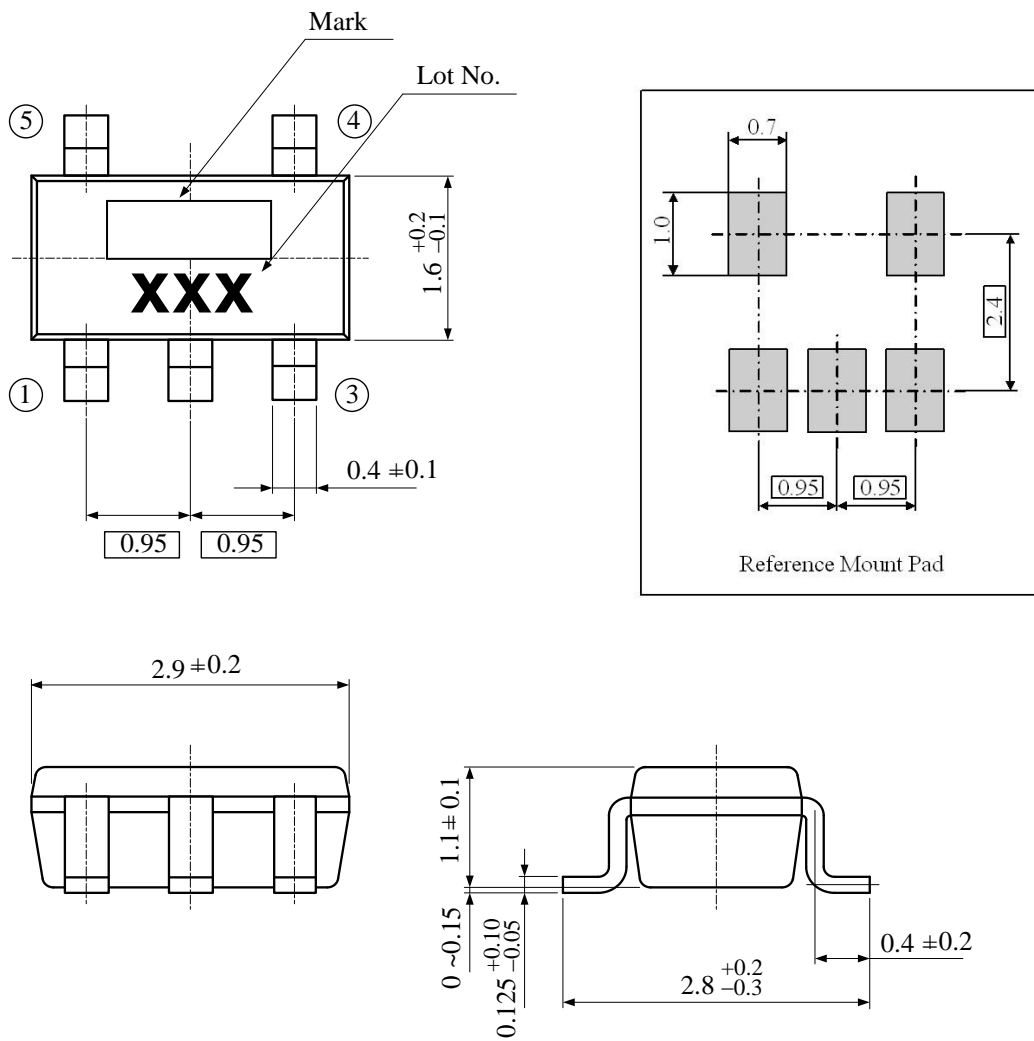

Figure 13. Test Circuit

14. Package

■Outline Dimensions

(Unit: mm)



15. Revise History

| Date (YY/MM/DD) | Revision | Page | Contents |
|--------------------|----------|------|---------------|
| 15/05/26 | 00 | - | First Edition |

IMPORTANT NOTICE

0. Asahi Kasei Microdevices Corporation (“AKM”) reserves the right to make changes to the information contained in this document without notice. When you consider any use or application of AKM product stipulated in this document (“Product”), please make inquiries the sales office of AKM or authorized distributors as to current status of the Products.
1. All information included in this document are provided only to illustrate the operation and application examples of AKM Products. AKM neither makes warranties or representations with respect to the accuracy or completeness of the information contained in this document nor grants any license to any intellectual property rights or any other rights of AKM or any third party with respect to the information in this document. You are fully responsible for use of such information contained in this document in your product design or applications. **AKM ASSUMES NO LIABILITY FOR ANY LOSSES INCURRED BY YOU OR THIRD PARTIES ARISING FROM THE USE OF SUCH INFORMATION IN YOUR PRODUCT DESIGN OR APPLICATIONS.**
2. The Product is neither intended nor warranted for use in equipment or systems that require extraordinarily high levels of quality and/or reliability and/or a malfunction or failure of which may cause loss of human life, bodily injury, serious property damage or serious public impact, including but not limited to, equipment used in nuclear facilities, equipment used in the aerospace industry, medical equipment, equipment used for automobiles, trains, ships and other transportation, traffic signaling equipment, equipment used to control combustions or explosions, safety devices, elevators and escalators, devices related to electric power, and equipment used in finance-related fields. Do not use Product for the above use unless specifically agreed by AKM in writing.
3. Though AKM works continually to improve the Product’s quality and reliability, you are responsible for complying with safety standards and for providing adequate designs and safeguards for your hardware, software and systems which minimize risk and avoid situations in which a malfunction or failure of the Product could cause loss of human life, bodily injury or damage to property, including data loss or corruption.
4. Do not use or otherwise make available the Product or related technology or any information contained in this document for any military purposes, including without limitation, for the design, development, use, stockpiling or manufacturing of nuclear, chemical, or biological weapons or missile technology products (mass destruction weapons). When exporting the Products or related technology or any information contained in this document, you should comply with the applicable export control laws and regulations and follow the procedures required by such laws and regulations. The Products and related technology may not be used for or incorporated into any products or systems whose manufacture, use, or sale is prohibited under any applicable domestic or foreign laws or regulations.
5. Please contact AKM sales representative for details as to environmental matters such as the RoHS compatibility of the Product. Please use the Product in compliance with all applicable laws and regulations that regulate the inclusion or use of controlled substances, including without limitation, the EU RoHS Directive. AKM assumes no liability for damages or losses occurring as a result of noncompliance with applicable laws and regulations.
6. Resale of the Product with provisions different from the statement and/or technical features set forth in this document shall immediately void any warranty granted by AKM for the Product and shall not create or extend in any manner whatsoever, any liability of AKM.
7. This document may not be reproduced or duplicated, in any form, in whole or in part, without prior written consent of AKM.