



PRODUCT SPECIFICATION

Part Number

PT322457E-TLMWU-EMR26

| | |
|----------------------|----------------------------------|
| CUSTOMER | |
| CUSTOMER PART NUMBER | |
| DESCRIPTION | 5.7" TFT LCD, Medium Bright, RTP |
| APPROVED BY | |
| DATE | |

**1. Table of Contents**

| No. | Contents | Page |
|------------|---|-------------|
| 1 | Table of Contents | 2 |
| 2 | Record of Revisions | 3 |
| 3 | Module Numbering System | 4 |
| 4 | Application | 5 |
| 5 | Features | 5 |
| 6 | General Specifications | 5 |
| 7 | Absolute Maximum Ratings | 6 |
| 8 | Electrical Characteristics | 7 |
| 9 | Block Diagram | 11 |
| 10 | Input / Output Terminals Pin Assignment | 12 |
| 11 | Interface Timing | 16 |
| 12 | Optical Characteristics | 18 |
| 13 | Reliability Test | 21 |
| 14 | Packaging | 22 |
| 15 | Precautions | 23 |
| 16 | Outline Drawing | 25 |
| 17 | Definition of Labels | 26 |
| 18 | Incoming Inspection Standards | 28 |
| | | |
| | | |
| | | |



3. Module Numbering System

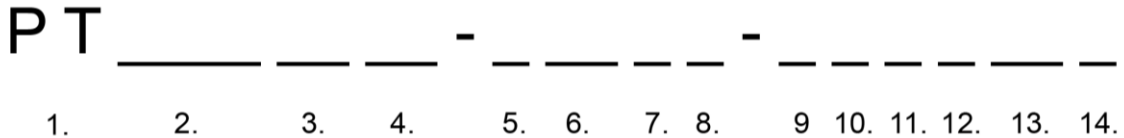

1. P-TEC TFT

2. LENGTH x WIDTH PIXELS

If third character is a zero, it is removed to shorten part number. Example: 240 x 320 = PT3224

3. DIAGONAL DIMENSIONS

Example: 3.5" display = 35 in part number

4. PRODUCT VERSION

Series assigned by P-tec

5. LCD MODE

T: TN
I: IPS
V: VA

6. POLARIZER

LM: Transmissive
LF: Transflective

7. BACKLIGHT COLOR

No Backlight: Left Blank
W: White
B: Blue/Green
S: Yellow/Green

8. VIEWING DIRECTION

D: 6 o'clock
U: 12 o'clock
F: Full Viewing Angle

9. A ~ Z CODE

Assigned by P-tec

11. TEMPERATURE RANGE

Normal: Left Blank
Wide: X

12. LUMINANCE

Blank: Normal (<300 nit)
M: Middle (>= 300 nit)
H: High (> 600 nit)

13. TOUCH PANEL OPTION

No TP: Left Blank
C: Capacitive TP
R: Resistive TP

14. SPECIAL CHARACTERS

Customer special requirements



4. Application

This specification is applied to the 5.7 inch QVGA supported TFT-LCD module, and can display true 262,144 colors(6 bit/ color). The module is designed for OA, Car TV application and other electronic products which require flat panel display of digital signal interface. This module is composed of a 5.7" TFT-LCD panel, a driver circuit and LED backlight unit and used as the input devices for general electric appliances via both finger and pen-entry.

5. Features

- QVGA (320×240 pixels) resolution.
- Digital 18 bit parallel RGB.
- Line inversion mode with stripe type.
- SYNC mode is supported for digital RGB input data format.
- LED driver circuit is built in this module to provide PWM Dimmer function.
- Transparent Touch panel
 - 4-Wire
 - Analog Resistive

6. General Specifications

| Item | Specifications | Unit |
|---------------------|---|------|
| Screen Size | 5.7 (Diagonal) | inch |
| Display Format | 320RGB(H)×240(V) | dot |
| Active Area | 115.2(H)×86.4(V) | mm |
| Dot Size | 0.120(H)×0.360(V) | mm |
| Pixel Configuration | RGB Vertical Stripe | - |
| Display Mode | TN Type Transmissive Mode Normally White | - |
| Surface Treatment | Anti-Glare and Hard Coating(3H) | - |
| Viewing Direction | 12 O'clock (The Gray Inversion will appear at this direction) | - |
| Outline Dimension | 144.0(W)×104.6(H)×14.5(D) | mm |
| Weight | (193) | g |
| RoHS Compliance | P-tec certifies this product to be in compliance with European Union Directive 2011/65/EU on the restriction of certain hazardous substances in electrical and electronic equipment | - |



7. Absolute Maximum Ratings

7.1 Absolute Ratings of Environment

| Item | Symbol | Value | | Unit | Note |
|-------------------------------|-----------------|-------|------|------|--------|
| | | Min. | Max. | | |
| Storage Temperature | T _{ST} | -30 | +80 | °C | (1)(2) |
| Operating Ambient Temperature | T _{OP} | -20 | +70 | °C | (1)(2) |

Note1: Background color changes slightly depending on ambient temperature.

This phenomenon is reversible.

Note2: Please refer to item of RELIABILITY.

7.2 Electrical Absolute Ratings

7.2.1 TFT-LCD Module

(Ta=25±2°C, GND=V_{SS}=0V)

| Item | Symbol | Value | | Unit | Note |
|------------------------------|-----------------|-------|------|------|------|
| | | Min. | Max. | | |
| Digital Power Supply Voltage | V _{CC} | -0.3 | 4.3 | V | - |

7.2.2 LED Driver Absolute Maximum Ratings

(Ta=25±2°C)

| Item | Symbol | Value | | Unit | Note |
|---------------------------|------------------|-------|------|------|------|
| | | Min. | Max. | | |
| LED Driver Supply Voltage | V _{LED} | -0.3 | 17 | V | (1) |
| LED Driver PWM | PWM | -0.3 | 6 | V | (1) |

Note (1) Permanent damage to the device may occur if maximum values are exceeded or reverse voltage is loaded.



8. Electrical Characteristics

8.1 TFT-LCD Module

(Ta=25±2°C)

| Item | Symbol | Value | | | Unit | Note |
|------------------------------|-----------------|--------------------|-------|--------------------|------|------|
| | | Min. | Typ. | Max. | | |
| Power Supply Voltage | V _{CC} | 3.0 | 3.3 | 3.6 | V | - |
| Input High Threshold Voltage | V _{IH} | 0.7V _{CC} | - | V _{CC} | V | - |
| Input Low Threshold Voltage | V _{IL} | 0 | - | 0.3V _{CC} | V | - |
| Power Supply Current | I _{CC} | - | 27.0 | 37.8 | mA | (1) |
| Power Consumption | P _L | | 0.089 | 0.125 | W | (1) |
| Frame Frequency | F _V | - | 60 | - | Hz | - |
| Dot Clock | CLK | - | 6.4 | 7 | MHz | - |

Note (1) The specified power consumption is under the conditions at V_{CC}=3.3V, F_V=60Hz, whereas a power dissipation check pattern below is displayed.

Black Pattern / 0 Gray

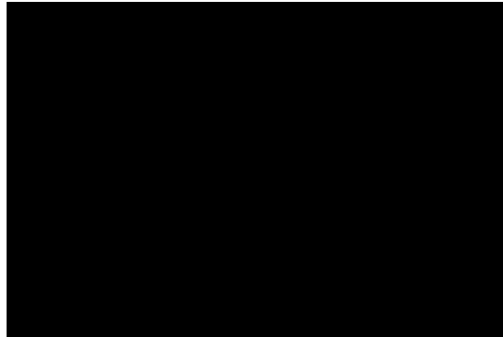

Active Area

**8.2 LED Driver Unit**

(Ta=25±2°C)

| Item | Symbol | Value | | | Unit | Note |
|----------------------------|----------------------|-------|-------|------|------|---|
| | | Min. | Typ. | Max. | | |
| Voltage of LED Driver Unit | V _{LED(DU)} | 4.5 | 5 | 12.5 | V | - |
| Voltage of LED Driver Unit | V _{LED(DU)} | 4.5 | 12 | 12.5 | V | - |
| Current of LED Driver Unit | I _{LED(DU)} | - | 500 | 700 | mA | I _{LED} =200mA, V _{LED} =5V |
| Current of LED Driver Unit | I _{LED(DU)} | - | 370 | 518 | mA | I _{LED} =150mA, V _{LED} =5V |
| Current of LED Driver Unit | I _{LED(DU)} | - | 260 | 364 | mA | I _{LED} =100mA, V _{LED} =5V |
| Current of LED Driver Unit | I _{LED(DU)} | - | 230 | 322 | mA | I _{LED} =200mA, V _{LED} =12V |
| Current of LED Driver Unit | I _{LED(DU)} | - | 170 | 238 | mA | I _{LED} =150mA, V _{LED} =12V |
| Current of LED Driver Unit | I _{LED(DU)} | - | 110 | 154 | mA | I _{LED} =100mA, V _{LED} =12V |
| Dimmer signal Low voltage | VPWML | - | - | 0.2 | V | - |
| Dimmer signal High voltage | VPWMH | 4 | 5.0 | 5.5 | V | - |
| Dimmer frequency | fPWM | - | 120 | - | Hz | - |
| PWM Pulse width | TPWMH | 10 | | | us | - |
| LED Life Time(25°C) | - | 40000 | 50000 | - | hr | (1)(2) |

PWM=High:ON, PWM=Low:OFF

Note (1) : LED life time is defined as under 25±2°C , when the average brightness decrease to 50% of original brightness

Note (2) : Lifetime statement is concerning to the max backlight current of 200mA.



8.3 Transparent Touch panel

Electrical characteristics

| Item | | Value | | | Unit | Note |
|-----------------------|-------------|---------------------|------|------|----------|--------------|
| | | Min. | Typ. | Max. | | |
| Operating Voltage | | - | 5 | 7 | V | - |
| Terminal Resistance | X-direction | 290 | - | 880 | Ω | At connector |
| | Y-direction | 260 | - | 530 | Ω | At connector |
| Insulation Resistance | | $\geq 20M\Omega$ | | | | At DC25V |
| Linearity | | $\leq 1.5\%$ | | | | (1) |
| Chatting | | $\leq 10\text{ ms}$ | | | | At connector |

Note(1): Measurement condition of Linearity

Linearity Definition

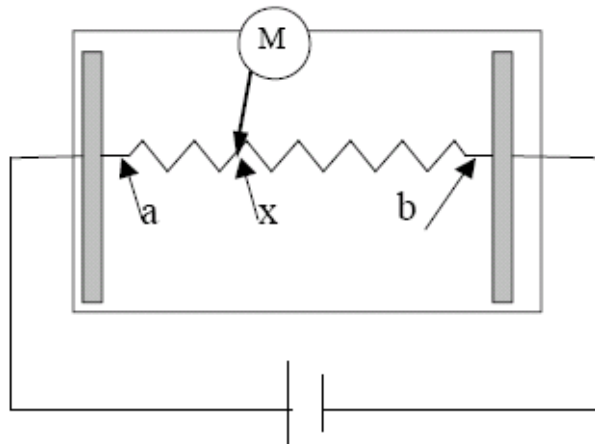

Va : maximum voltage in the active area of touch panel

Vb: minimum voltage in the active area of touch panel

X : random measuring point

Vxm: Actual voltage of Lx point

Vxi : Theoretical voltage of Lx point

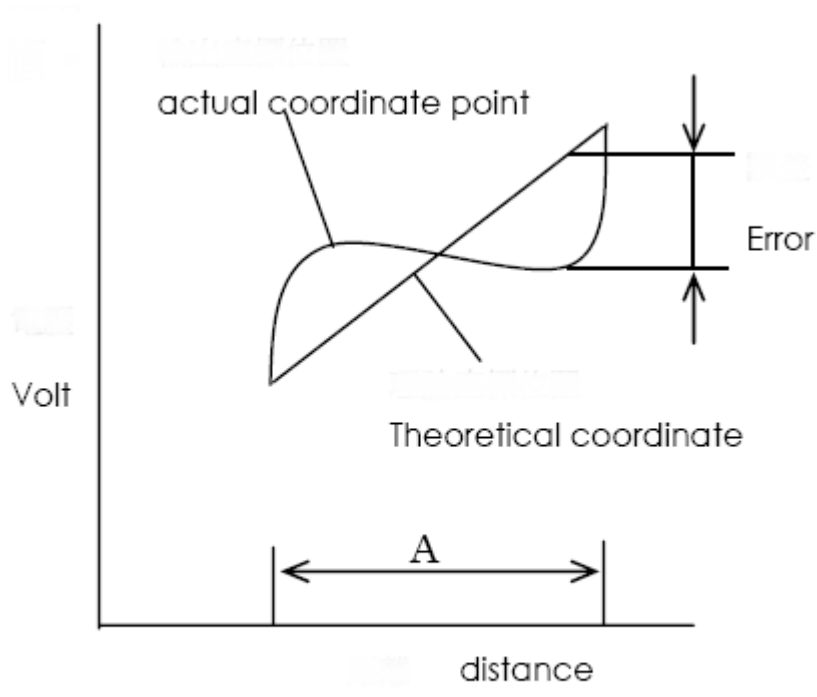

A: _____

Linearity : $[\frac{1}{2}V_{xi}-V_{xm}\frac{1}{2}/ (V_a-V_b)]*100\%$



9. Block Diagram

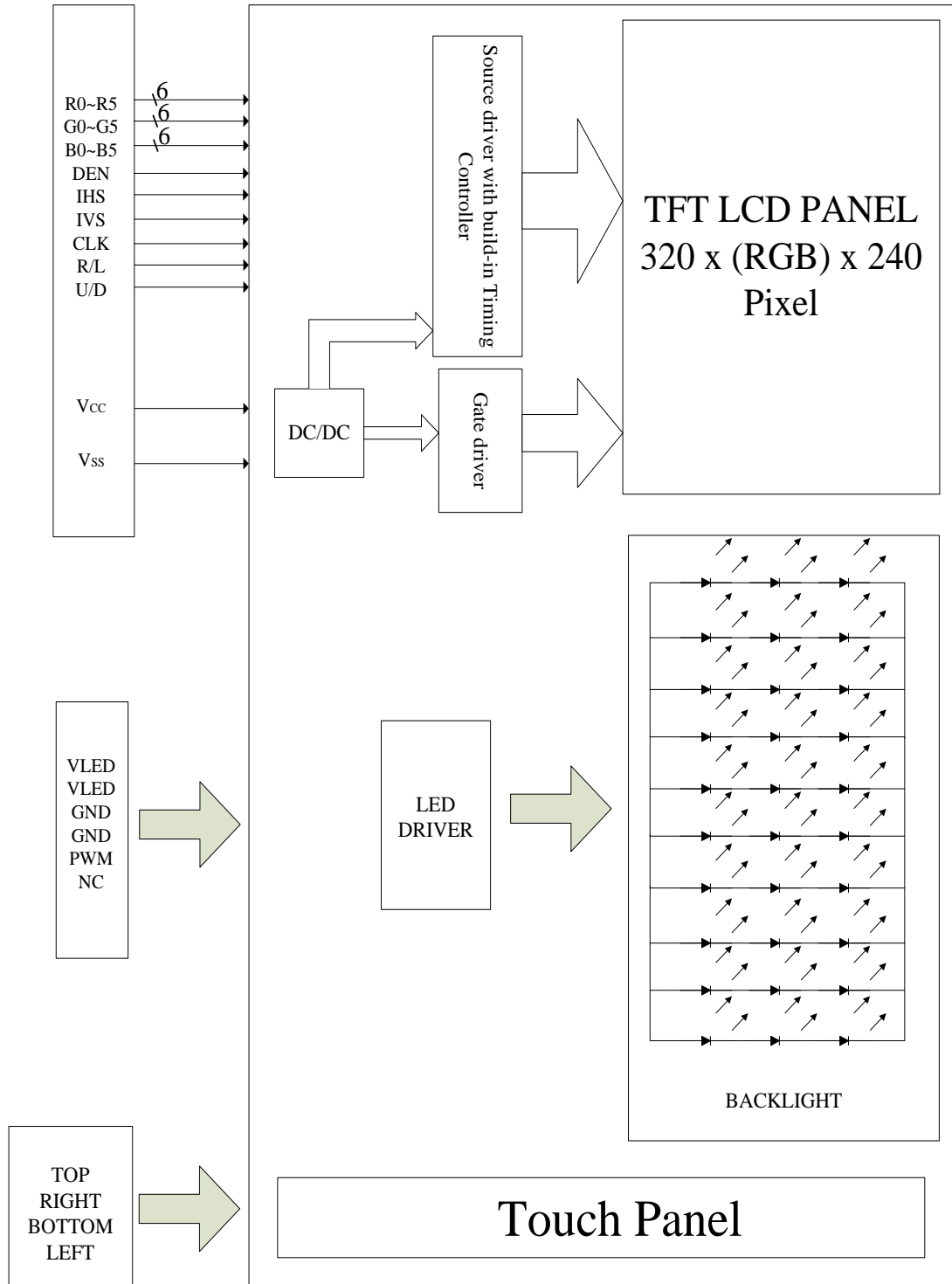



10. Input / Output Terminals Pin Assignment

10.1 TFT-LCD Module

Connector: CVILUX CF25331D0R0-05

| Pin No. | Symbol | I/O | Description |
|---------|--------|-----|---|
| 1 | Vss | I | Ground |
| 2 | CLK | I | Clock signal |
| 3 | IHS | I | Horizontal synchronous signal |
| 4 | IVS | I | Vertical synchronous signal |
| 5 | Vss | I | Ground |
| 6 | R0 | I | RED data (LSB) |
| 7 | R1 | I | RED data |
| 8 | R2 | I | RED data |
| 9 | R3 | I | RED data |
| 10 | R4 | I | RED data |
| 11 | R5 | I | RED data(MSB) |
| 12 | Vss | I | Ground |
| 13 | G0 | I | GREEN data(LSB) |
| 14 | G1 | I | GREEN data |
| 15 | G2 | I | GREEN data |
| 16 | G3 | I | GREEN data |
| 17 | G4 | I | GREEN data |
| 18 | G5 | I | GREEN data(MSB) |
| 19 | Vss | I | Ground |
| 20 | B0 | I | Blue data(LSB) |
| 21 | B1 | I | Blue data |
| 22 | B2 | I | Blue data |
| 23 | B3 | I | Blue data |
| 24 | B4 | I | Blue data |
| 25 | B5 | I | Blue data(MSB) |
| 26 | Vss | I | Ground |
| 27 | DEN | I | Input data enable control |
| 28 | Vcc | I | +3.3V power supply |
| 29 | Vcc | I | +3.3V power supply |
| 30 | R/L | I | Right-and-Left scan setting. ("L" : Normally , "H" : Right-and-Left reversal) .Note(1) |



P-TEC

MODEL NO.

PT322457E-TLMWU-EMR26

**SPEC &
SAMPLE**

PAGE

13

| Pin No. | Symbol | I/O | Description |
|---------|--------|-----|---|
| 31 | U/D | I | Up/down scan setting. ("H": normal scan. "L": Up-and-Down reversal.) Note(1) |
| 32 | NC | I | No connection |
| 33 | Vss | I | Ground |

Note (1)

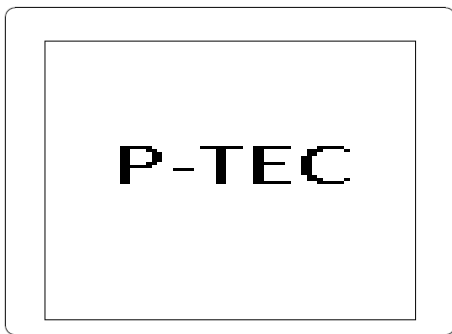

R/L=L, U/D=H

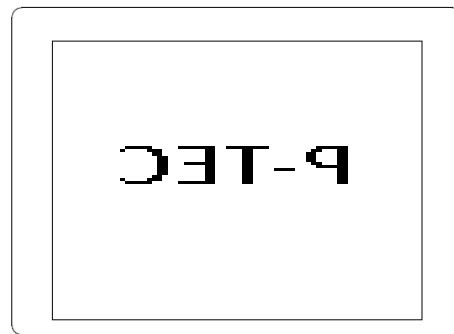

R/L=H, U/D=H

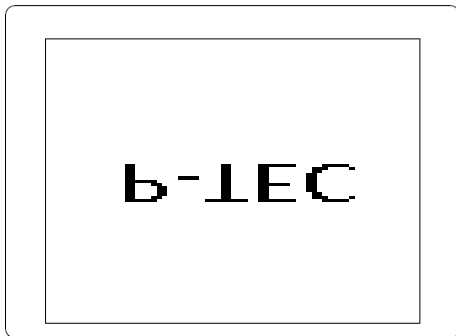

R/L=L, U/D=L

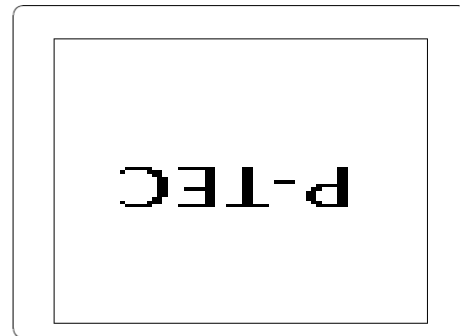

R/L=H, U/D=L



10.2 Backlight Unit

Employed Connector : CVILUX CI1106M1HR0-LF

Adapted connector : CVILUX CI1106S

JST SHR-06V-S

JST SHR-06V-S-B

| Pin No. | Symbol | Description |
|---------|--------|---|
| 1 | VLED | LED drive circuit power supply (4.5~12.5V) |
| 2 | VLED | LED drive circuit power supply (4.5~12.5V) |
| 3 | GND | Ground |
| 4 | GND | Ground |
| 5 | PWM | PWM Dimmer |
| 6 | NC | NO CONNECTION |

JUMP: HCH HDS502-E

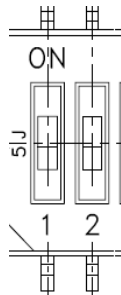

| PIN 1 | PIN2 | Result |
|-------|------|--------|
| ON | ON | 200mA |
| ON | OFF | 150mA |
| OFF | ON | 150mA |
| OFF | OFF | 100mA |

10.3 Transparent Touch Panel

Connector: CVILUX CF25041D0R0-10

| Pin No. | Symbol |
|---------|--------|
| 1 | TOP |
| 2 | RIGHT |
| 3 | BOTTOM |
| 4 | LEFT |



10.4 Color Data Input Assignment

The brightness of each primary color(red, green and blue) is based on the 6 bit gray scale data input for the color. The higher the binary input, the brighter the color. The table provides the assignment of color versus data input.

| Color | | Data Signal | | | | | | | | | | | | | | | | | |
|---------------------|-----------------|-------------|----|----|----|----|----|-------|----|----|----|----|----|------|----|----|----|----|----|
| | | Red | | | | | | Green | | | | | | Blue | | | | | |
| | | R5 | R4 | R3 | R2 | R1 | R0 | G5 | G4 | G3 | G2 | G1 | G0 | B5 | B4 | B3 | B2 | B1 | B0 |
| Basic Colors | Black | 0 | 0 | 0 | 0 | 0 | 0 | 0 | 0 | 0 | 0 | 0 | 0 | 0 | 0 | 0 | 0 | 0 | 0 |
| | Red | 1 | 1 | 1 | 1 | 1 | 1 | 0 | 0 | 0 | 0 | 0 | 0 | 0 | 0 | 0 | 0 | 0 | 0 |
| | Green | 0 | 0 | 0 | 0 | 0 | 0 | 1 | 1 | 1 | 1 | 1 | 1 | 0 | 0 | 0 | 0 | 0 | 0 |
| | Blue | 0 | 0 | 0 | 0 | 0 | 0 | 0 | 0 | 0 | 0 | 0 | 0 | 1 | 1 | 1 | 1 | 1 | 1 |
| | Cyan | 0 | 0 | 0 | 0 | 0 | 0 | 1 | 1 | 1 | 1 | 1 | 1 | 1 | 1 | 1 | 1 | 1 | 1 |
| | Magenta | 1 | 1 | 1 | 1 | 1 | 1 | 0 | 0 | 0 | 0 | 0 | 0 | 1 | 1 | 1 | 1 | 1 | 1 |
| | Yellow | 1 | 1 | 1 | 1 | 1 | 1 | 1 | 1 | 1 | 1 | 1 | 1 | 0 | 0 | 0 | 0 | 0 | 0 |
| | White | 1 | 1 | 1 | 1 | 1 | 1 | 1 | 1 | 1 | 1 | 1 | 1 | 1 | 1 | 1 | 1 | 1 | 1 |
| Gray Scale Of RED | Red(0) / Dark | 0 | 0 | 0 | 0 | 0 | 0 | 0 | 0 | 0 | 0 | 0 | 0 | 0 | 0 | 0 | 0 | 0 | 0 |
| | Red(1) | 0 | 0 | 0 | 0 | 0 | 1 | 0 | 0 | 0 | 0 | 0 | 0 | 0 | 0 | 0 | 0 | 0 | 0 |
| | Red(2) | 0 | 0 | 0 | 0 | 1 | 0 | 0 | 0 | 0 | 0 | 0 | 0 | 0 | 0 | 0 | 0 | 0 | 0 |
| | : | : | : | : | : | : | : | : | : | : | : | : | : | : | : | : | : | : | : |
| | : | : | : | : | : | : | : | : | : | : | : | : | : | : | : | : | : | : | : |
| | Red(61) | 1 | 1 | 1 | 1 | 0 | 1 | 0 | 0 | 0 | 0 | 0 | 0 | 0 | 0 | 0 | 0 | 0 | 0 |
| | Red(62) | 1 | 1 | 1 | 1 | 1 | 0 | 0 | 0 | 0 | 0 | 0 | 0 | 0 | 0 | 0 | 0 | 0 | 0 |
| | Red(63) | 1 | 1 | 1 | 1 | 1 | 1 | 0 | 0 | 0 | 0 | 0 | 0 | 0 | 0 | 0 | 0 | 0 | 0 |
| Gray Scale Of Green | Green(0) / Dark | 0 | 0 | 0 | 0 | 0 | 0 | 0 | 0 | 0 | 0 | 0 | 0 | 0 | 0 | 0 | 0 | 0 | 0 |
| | Green(1) | 0 | 0 | 0 | 0 | 0 | 0 | 0 | 0 | 0 | 0 | 0 | 1 | 0 | 0 | 0 | 0 | 0 | 0 |
| | Green(2) | 0 | 0 | 0 | 0 | 0 | 0 | 0 | 0 | 0 | 0 | 1 | 0 | 0 | 0 | 0 | 0 | 0 | 0 |
| | : | : | : | : | : | : | : | : | : | : | : | : | : | : | : | : | : | : | : |
| | : | : | : | : | : | : | : | : | : | : | : | : | : | : | : | : | : | : | : |
| | Green(61) | 0 | 0 | 0 | 0 | 0 | 0 | 1 | 1 | 1 | 1 | 0 | 1 | 0 | 0 | 0 | 0 | 0 | 0 |
| | Green(62) | 0 | 0 | 0 | 0 | 0 | 0 | 1 | 1 | 1 | 1 | 1 | 0 | 0 | 0 | 0 | 0 | 0 | 0 |
| | Green(63) | 0 | 0 | 0 | 0 | 0 | 0 | 1 | 1 | 1 | 1 | 1 | 1 | 0 | 0 | 0 | 0 | 0 | 0 |
| Gray Scale Of Blue | Blue(0) / Dark | 0 | 0 | 0 | 0 | 0 | 0 | 0 | 0 | 0 | 0 | 0 | 0 | 0 | 0 | 0 | 0 | 0 | 0 |
| | Blue(1) | 0 | 0 | 0 | 0 | 0 | 0 | 0 | 0 | 0 | 0 | 0 | 0 | 0 | 0 | 0 | 0 | 0 | 1 |
| | Blue(2) | 0 | 0 | 0 | 0 | 0 | 0 | 0 | 0 | 0 | 0 | 0 | 0 | 0 | 0 | 0 | 0 | 1 | 0 |
| | : | : | : | : | : | : | : | : | : | : | : | : | : | : | : | : | : | : | : |
| | : | : | : | : | : | : | : | : | : | : | : | : | : | : | : | : | : | : | : |
| | Blue(61) | 0 | 0 | 0 | 0 | 0 | 0 | 0 | 0 | 0 | 0 | 0 | 0 | 1 | 1 | 1 | 1 | 0 | 1 |
| | Blue(62) | 0 | 0 | 0 | 0 | 0 | 0 | 0 | 0 | 0 | 0 | 0 | 0 | 1 | 1 | 1 | 1 | 1 | 0 |
| | Blue(63) | 0 | 0 | 0 | 0 | 0 | 0 | 0 | 0 | 0 | 0 | 0 | 0 | 1 | 1 | 1 | 1 | 1 | 1 |

**11. Interface Timing****11.1 Input Signal Characteristics**

| PARAMETER | | Symbol | Min. | Typ. | Max. | Unit |
|-----------------|------|-----------|------|-------|------|-----------|
| CLK period | | T_{OSC} | - | 156 | - | ns |
| Data setup time | | T_{SU} | 12 | - | - | ns |
| Data hold time | | T_{HD} | 12 | - | - | ns |
| IHS period | | T_H | - | 408 | - | T_{OSC} |
| IHS pulse width | | T_{HS} | 5 | 30 | - | T_{OSC} |
| IHS setup time | | T_{Cr} | 12 | - | - | ns |
| IHS hold time | | T_{Cf} | 12 | - | - | ns |
| IVS pulse width | | T_{VS} | 1 | 3 | 5 | T_H |
| IVS setup time | | T_{Vr} | 12 | - | - | ns |
| IVS hold time | | T_{Vf} | 12 | - | - | μs |
| IVS-DEN time | NTSC | T_{VSE} | - | 18 | - | T_H |
| | PAL | T_{VSE} | - | 26 | - | T_H |
| IHS-DEN time | | T_{HE} | 36 | 68 | 88 | T_{OSC} |
| DEN pulse width | | T_{EP} | - | 320 | - | T_{OSC} |
| DEN-STH time | | T_{DES} | - | 1 | - | T_{OSC} |
| IVS period | NTSC | - | - | 262.5 | - | T_H |
| | PAL | - | - | 312.5 | - | T_H |

Note: When SYNC mode is used, 1st data start from 68th CLK after IHS falling.



11.2 Waveform

11.2.1 Clock and Data Waveform

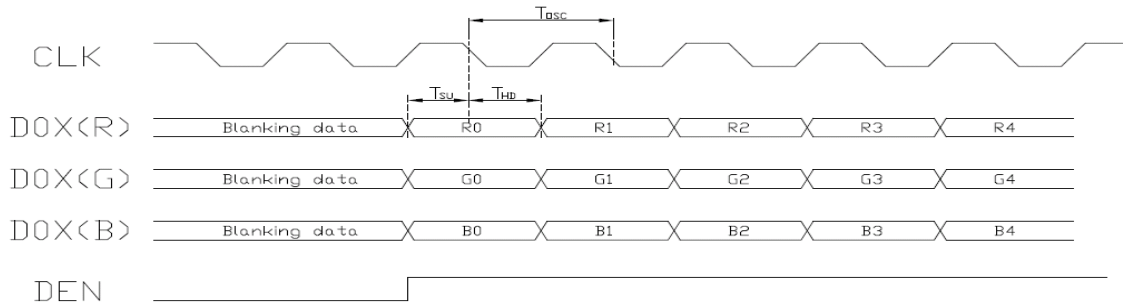

11.2.2 Clock and Sync waveforms

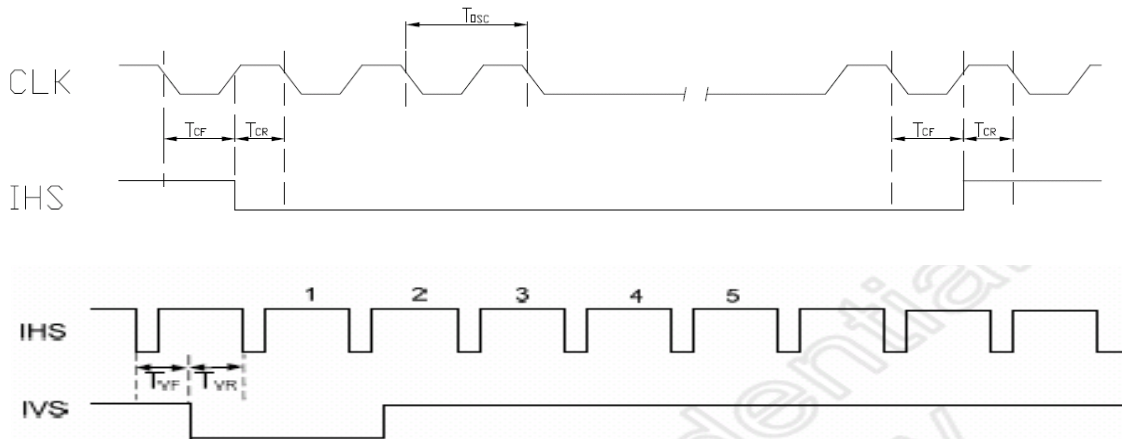

11.2.3 IHS and horizontal control timing waveforms

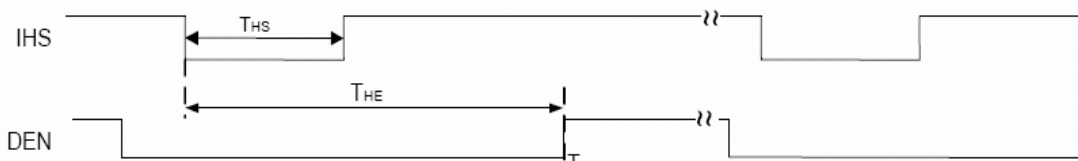

11.2.4 IHS and vertical control timing waveforms

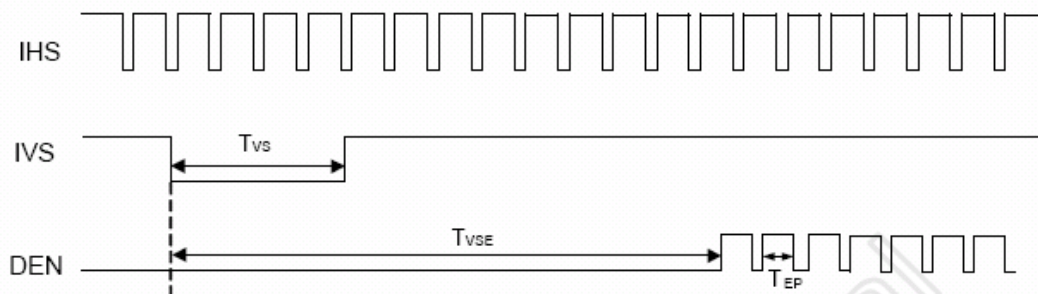

**12. Optical Characteristics**

The optical characteristics should be measured in a dark environment (≤ 1 lux) or equivalent state with the methods shown in Note (4).

| Item | Symbol | Conditions | Min. | Typ. | Max. | Unit | Note |
|-----------------------|------------|--------------------------------------|-------|-------|-------|-------------------|---------|
| Contrast Ratio | CR | $\theta_x=0^\circ, \theta_y=0^\circ$ | 300 | (450) | - | - | (2) |
| Response Time | T_R | Viewing Normal | - | 15 | - | ms | (3) |
| | T_F | Angle | - | 35 | - | ms | |
| Luminance(Center) | Y | B/L=200mA | 495 | (545) | - | cd/m ² | (4) |
| | | B/L=150mA | 385 | (450) | - | cd/m ² | |
| | | B/L=100mA | 270 | (320) | - | cd/m ² | |
| Brightness uniformity | BUNI | | 75 | (80) | - | % | (5) |
| Color Chromaticity | Red | Rx | 0.590 | 0.640 | 0.690 | - | (1),(4) |
| | | Ry | 0.300 | 0.350 | 0.400 | - | |
| | Green | Gx | 0.310 | 0.360 | 0.410 | - | |
| | | Gy | 0.530 | 0.580 | 0.630 | - | |
| | Blue | Bx | 0.095 | 0.145 | 0.195 | - | |
| | | By | 0.030 | 0.080 | 0.130 | - | |
| | White | Wx | 0.280 | 0.330 | 0.380 | - | |
| | | Wy | 0.280 | 0.330 | 0.380 | - | |
| Viewing Angle | Horizontal | θ_{x+} | 55 | (60) | - | deg. | |
| | | θ_{x-} | 55 | (60) | - | | |
| | Vertical | θ_{y+} | 55 | (60) | - | | |
| | | θ_{y-} | 45 | (50) | - | | |



Note (1) Definition of Viewing Angle (θ_x, θ_y):

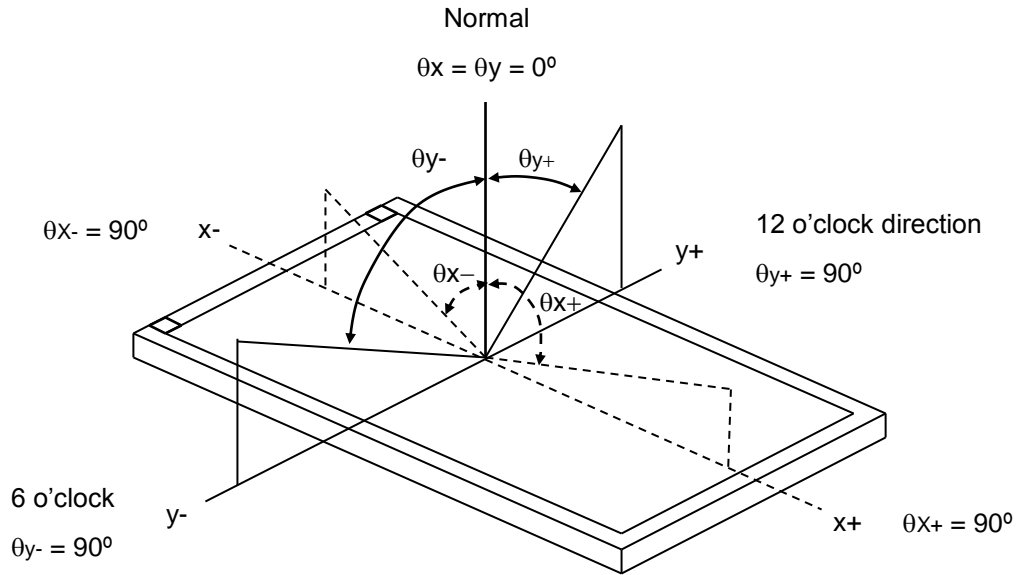

Note (2) Definition of Contrast Ratio (CR):

$$\text{Contrast ratio (CR)} = \frac{\text{Luminance measured when LCD on the "White" state}}{\text{Luminance measured when LCD on the "Black" state}}$$

Note (3) Definition of Response Time (T_R, T_F):

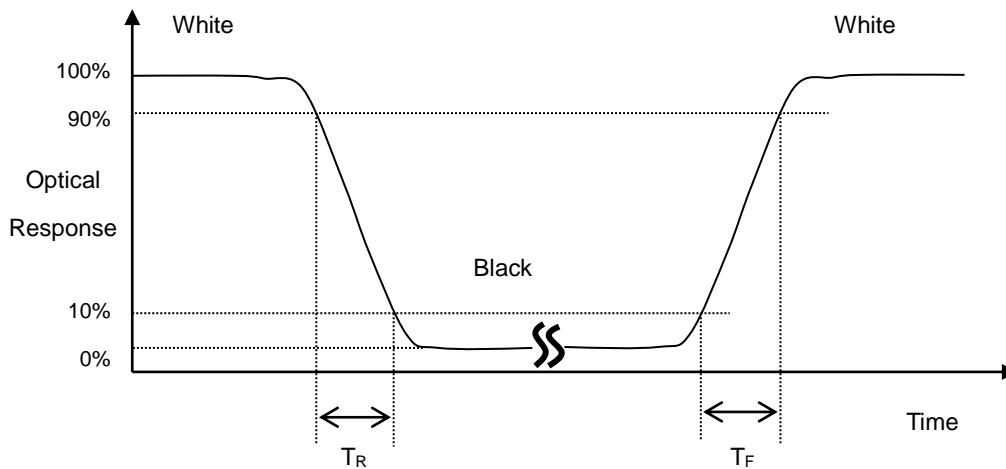



Note (4) Measurement Set-Up:

The LCD module should be stabilized at a given temperature for 30 minutes to avoid abrupt temperature change during measuring. In order to stabilize the luminance, the measurement should be executed after lighting Backlight for 30 minutes in a windless room.

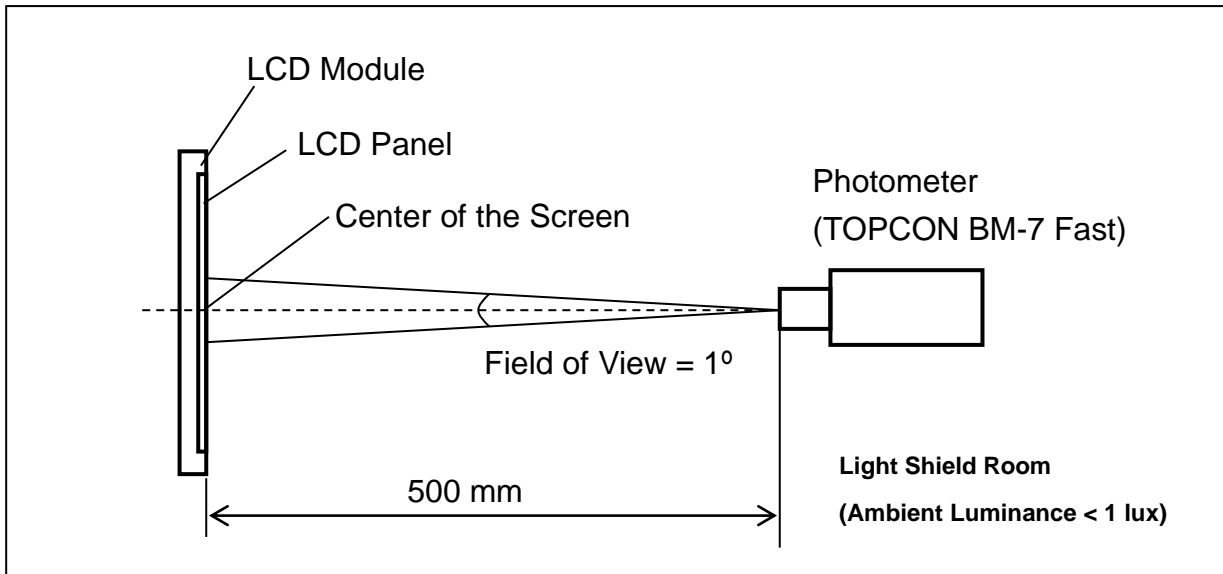

Note (5) Definition of brightness uniformity

Brightness uniformity=(Min Luminance of 9 points)/(Max Luminance of 9 points)×100%

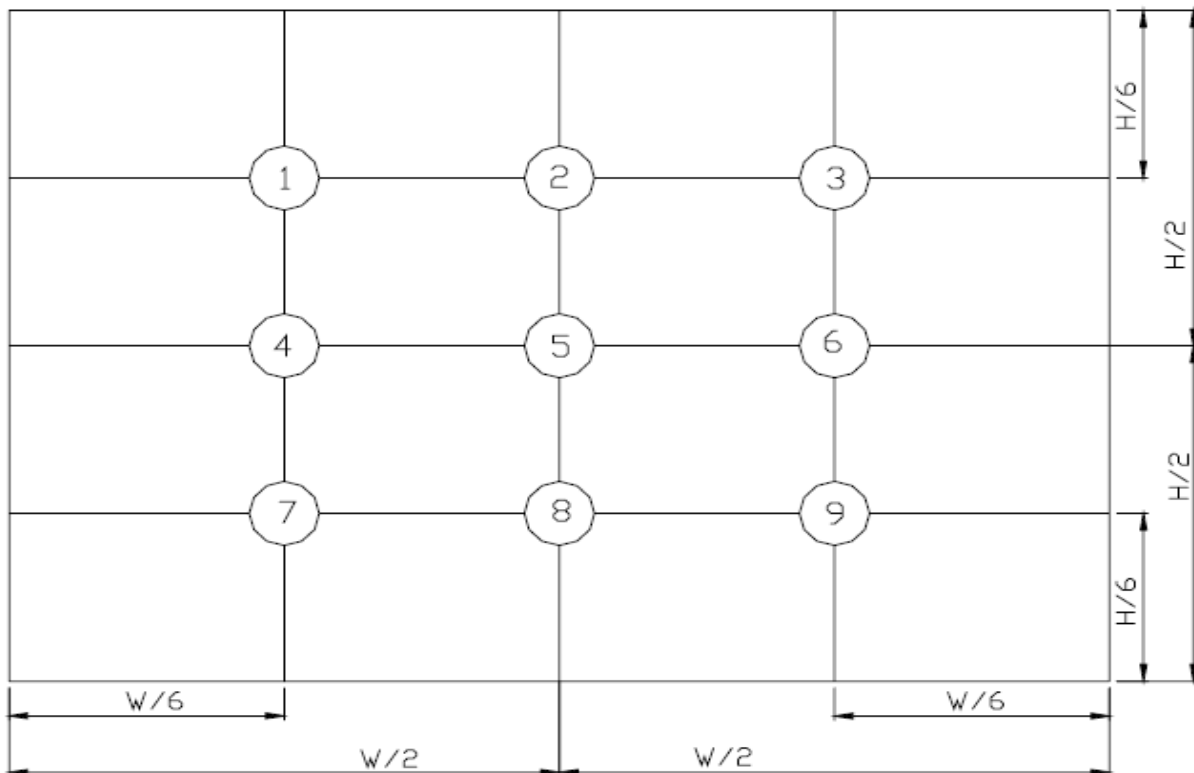

**13. Reliability Test**

| No. | Test Items | Test Condition | Remark |
|-----|---|---|-------------|
| 1 | High Temperature Storage Test | T _a = 80°C 240 hours | (1),(3),(4) |
| 2 | Low Temperature Storage Test | T _a = -30°C 240 hours | (1),(3),(4) |
| 3 | High Temperature Operation Test | T _s = 70°C 240 hours | (2),(3),(4) |
| 4 | Low Temperature Operation Test | T _a = -20°C 240 hours | (1),(3),(4) |
| 5 | High Temperature and High Humidity Operation Test | T _a =60°C 90%RH 240 hours | (3),(4) |
| 6 | Electro Static Discharge Test (non-operating) | -Panel Surface/Top Case : 150pF, 330Ω Air: ±15kV, Contact: ±8kV | (3) |
| 7 | Mechanical Shock Test (non-operating) | Half sine wave, 100G, 6ms 3 times shock of each six surfaces | (3) |
| 8 | Vibration Test (non-operating) | Sine wave, 10 ~ 55 ~ 10Hz, 3 axis, 2 hours/axis | (3) |
| 9 | Thermal Shock Test (non-operating) | -20°C (30min) ~ 70°C (30min), 100 cycles | (3),(4) |
| 10 | Drop Test(with Carton) | Height: 80cm 1 corner, 3 edges, 6 surfaces | (3) |

Note 1: T_a is the ambient temperature of samples.

Note 2: T_s is the temperature of panel's surface.

Note 3: In the standard condition, there shall be no practical problem that may affect the display function.
After the reliability test, the product only guarantees operation, but don't guarantee all of the cosmetic specification.

Note 4: Before cosmetic and function test, the product must have enough recovery time, at least 2 hours at room temperature.



14. Packaging

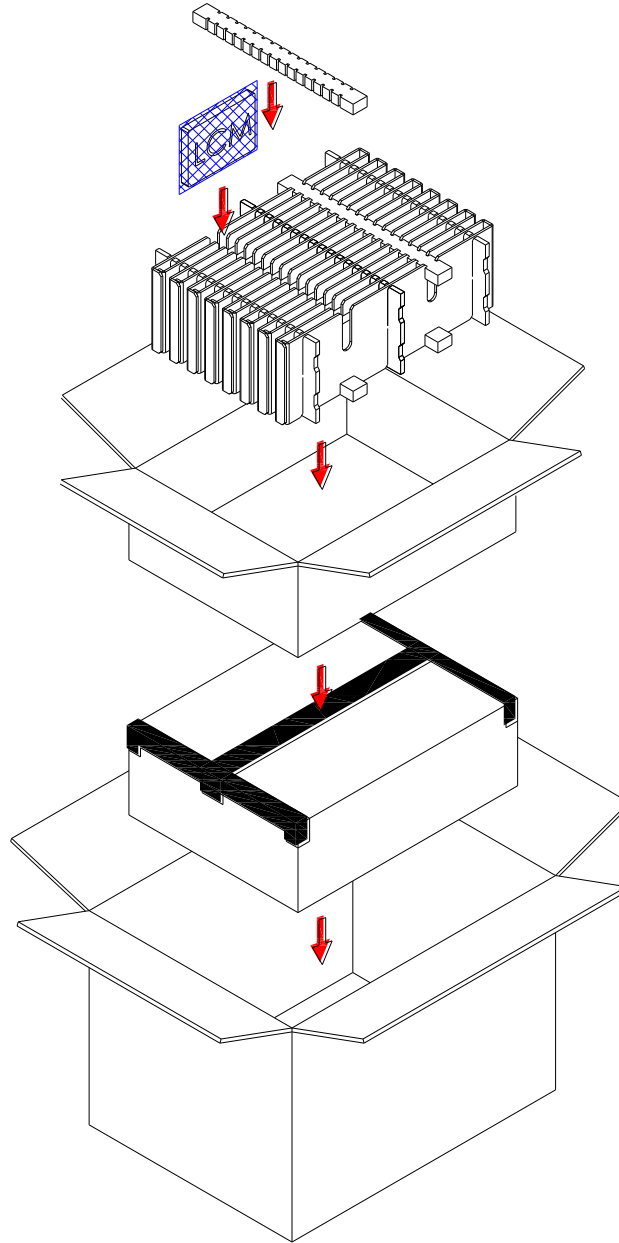

PARTS LIST

| | ITEM | SIZE(LxWxH) unit:mm | MATERIAL | Q.T.Y | NOTE |
|---|----------------------|---------------------|----------|-------|------|
| 1 | STATIC SHIEDING BAGS | 300.0x145.0x0.09 | | 60 | |
| 2 | EPE PAD | 345.0x30.0x20.0 | EPE | 8 | |
| 3 | CARD BOARD | 345.0x150.0x3.5 | CARTON | 6 | |
| 4 | CARD BOARD | 450.0x23.0x150.0 | CARTON | 16 | |
| 5 | INTERNAL BOX | 455.0x350.0x164.0 | CARTON | 2 | |
| 6 | EXTERNAL BOX | 475.0x370.0x375.0 | CARTON | 1 | |
| 7 | PRODUCT | 144.0x104.6x14.5 | | 60 | |



15. Precautions

15.1 Assembly and Handling Precautions

- (1) Do not apply rough force such as bending or twisting to the module during assembly.
- (2) It's recommended to assemble or to install a module into the user's system in clean working areas. The dust and oil may cause electrical short or worsen the polarizer.
- (3) Don't apply pressure or impulse to the module to prevent the damage of LCD panel and Backlight.
- (4) Always follow the correct power-on sequence when the LCD module is turned on. This can prevent the damage and latch-up of the CMOS LSI chips.
- (5) Do not plug in or pull out the I/F connector while the module is in operation.
- (6) Do not disassemble the module.
- (7) Use a soft dry cloth without chemicals for cleaning, because the surface of polarizer is very soft and easily scratched.
- (8) Moisture can easily penetrate into LCD module and may cause the damage during operation.
- (9) High temperature or humidity may deteriorate the performance of LCD module. Please store LCD module in the specified storage conditions.
- (10) When ambient temperature is lower than 10°C, the display quality might be reduced. For example, the response time will become slow.

15.2 Safety Precautions

- (1) If the liquid crystal material leaks from the panel, it should be kept away from the eyes or mouth. In case of contact with hands, skin or clothes, it has to be washed away thoroughly with soap.
- (2) After the module's end of life, it is not harmful in case of normal operation and storage.

15.3 Terms of Warrant

- (1) Acceptance inspection period
The period is within one month after the arrival of contracted commodity at the buyer's factory site.
- (2) Applicable warrant period
The period is within twelve months since the date of shipping out under normal using and storage conditions.



15.4 Cautions for installing and assembling

Bezel edge must be positioned in the area between the Active area and View area. The bezel may press the touch screen and cause activation if the edge touches the active area. A gap of approximately 0.5mm is needed between the bezel and the top electrode. It may cause unexpected activation if the gap is too narrow. There is a tolerance of 0.2 to 0.3mm for the outside dimensions of the touch panel and tail. A gap must be made to absorb the tolerance in the case and connector.

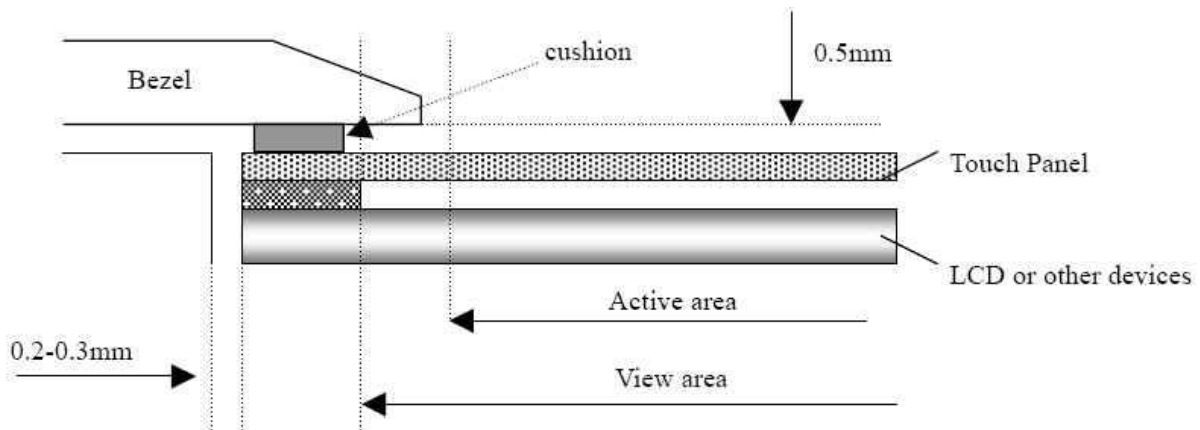

15.5 Operation Prohibit

Not Suggested Pen Input Position On Touch Panel

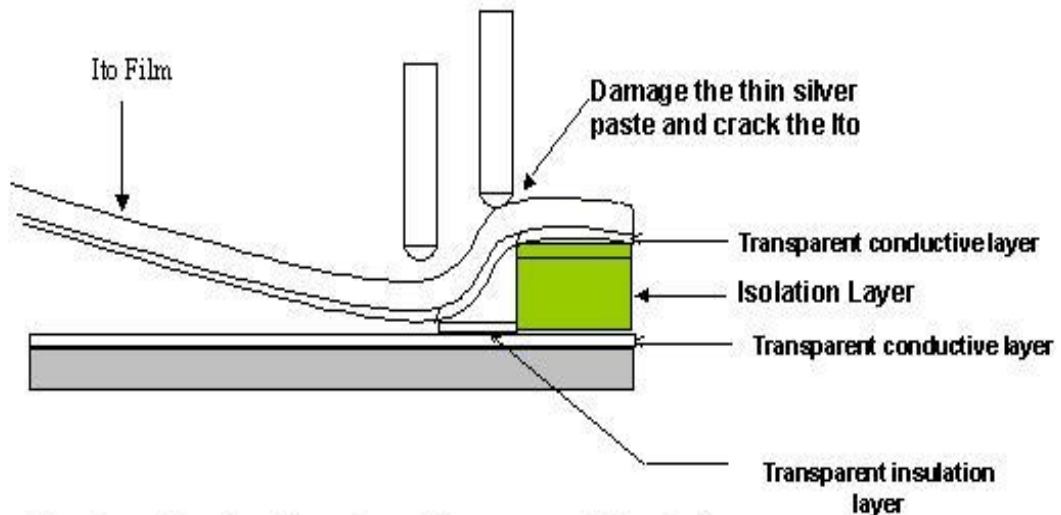

Pen input load on the edge of transparent insulation area might damage the ITO of ITO Pet- Film and reduce the durability of touch panel



16. Outline Drawing

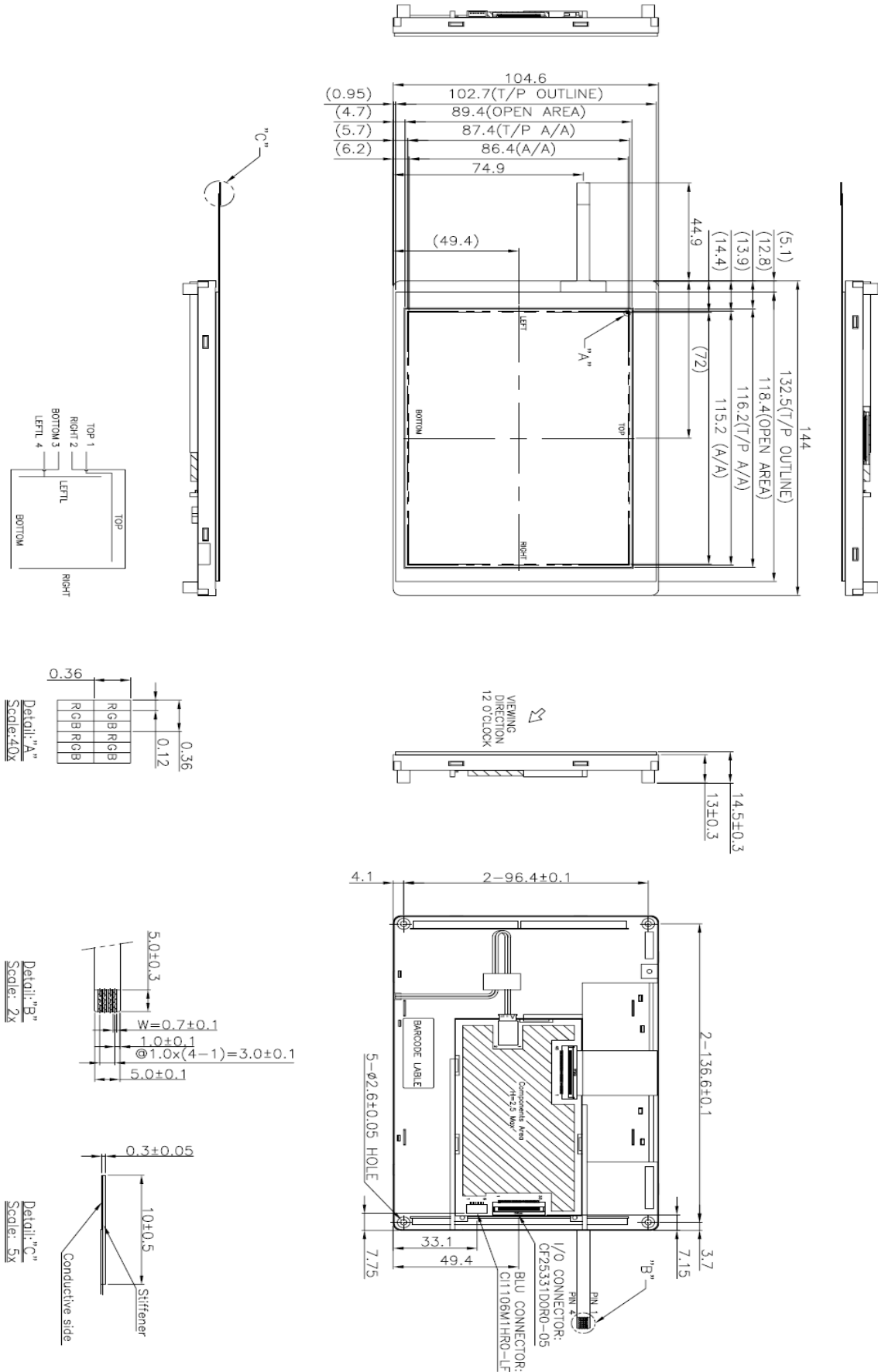



17. Definition of Labels

The bar code nameplate is pasted on each module as illustration, and its definitions are as following explanation.



PT322457E-TLMWU-EMR26

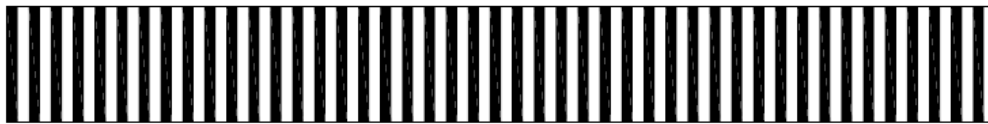

ABCDEFGHIJKLM

(a) Module Name: PT322457E-TLMWU-EMR26

(b) Serial ID:

A B C D E F G H I J K L M

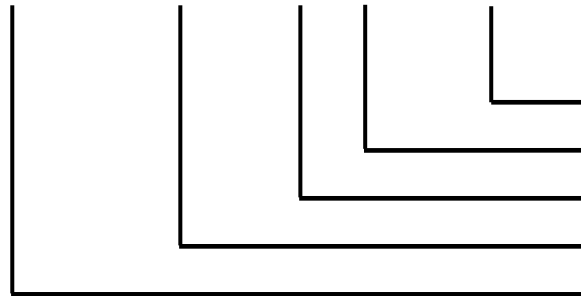

Serial No.
Revision Code
Factory Code
Manufactured Date
Screen Size

Serial ID includes the information as below:

(a) Screen size (Diagonal): Inch Code (ABCD)

3.5" → 0350

10.4" → 1040

(b) Manufactured Date: Year, Month, Day (EFG)

Year (E)

| | | | | | | | | | | |
|------|------|------|------|------|------|------|------|------|------|------|
| Year | 2000 | 2001 | 2002 | 2003 | 2004 | 2005 | 2006 | 2007 | 2008 | 2009 |
| Mark | 0 | 1 | 2 | 3 | 4 | 5 | 6 | 7 | 8 | 9 |
| Year | 2010 | 2011 | 2012 | 2013 | 2014 | 2015 | 2016 | 2017 | 2018 | 2019 |
| Mark | A | B | C | D | E | F | G | H | I | J |



Month (F)

| | | | | | | | | | | | | |
|-------|------|------|------|------|-----|------|------|------|------|------|------|------|
| Month | Jan. | Feb. | Mar. | Apr. | May | Jun. | Jul. | Aug. | Sep. | Oct. | Nov. | Dec. |
| Mark | 1 | 2 | 3 | 4 | 5 | 6 | 7 | 8 | 9 | A | B | C |

Day (G)

| | | | | | | | | | | | | | | | | |
|------|----|----|----|----|----|----|----|----|----|----|----|----|----|----|----|----|
| Day | 1 | 2 | 3 | 4 | 5 | 6 | 7 | 8 | 9 | 10 | 11 | 12 | 13 | 14 | 15 | 16 |
| Mark | 1 | 2 | 3 | 4 | 5 | 6 | 7 | 8 | 9 | A | B | C | D | E | F | G |
| Day | 17 | 18 | 19 | 20 | 21 | 22 | 23 | 24 | 25 | 26 | 27 | 28 | 29 | 30 | 31 | |
| Mark | H | I | J | K | L | M | N | O | P | Q | R | S | T | U | V | |

(c) Factory Code (H):

For P-TEC internal use.

(d) Revision Code (I):

Cover all the change, for example: 1: Rev.1, 2: Rev.2, 3: Rev.3...etc.

(e) Serial No. (JKLM):

Manufacturing sequence of product, for example: 0001~9999.



18. Incoming Inspection Standards

18.1 The environmental condition of inspection

The environmental condition and visual inspection shall be conducted as below.

- (1) Ambient temperature $25 \pm 5^{\circ}\text{C}$
- (2) Humidity: $60 \pm 5\% \text{ RH}$
- (3) Viewing distance is approximately 35 ~ 40 cm
- (4) Viewing angle is normal to the LCD panel as Fig _1(10°)
- (5) Ambient Illumination: 300 ~ 500 Lux for external appearance inspection

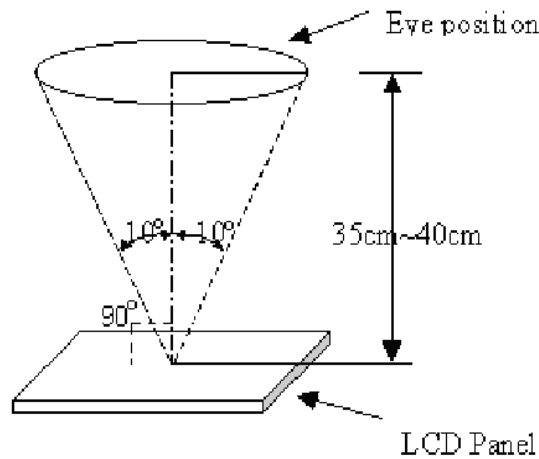

Fig _ 1

18.2 The defects classify of AQL as following:



| Class of defects | AQL | Definition |
|------------------|-------|--|
| Major | 0.65% | It is defect that is likely to result in failure or to reduce materially the usability of the intended function. |
| Minor | 1.5% | It is a defect that will not result in functioning problem with deviation classified. |



18.3 Inspection Parameters

| Item | | Specification/Description | | | Note | |
|--|--|--|-------------------|-------------------|------------|---------------|
| Display | Function | No Display | | | - | |
| | | Malfunction | | | - | |
| Operating | Contrast ratio | Out of Spec | | | - | |
| | Line defect | No obvious Vertical and Horizontal line defect in bright , dark and colored. | | | - | |
| | Point Defect (red,green,blue,dark, white) | Item | Acceptable number | | | Note: 1、4、5、6 |
| | | | A | B | Total | |
| | | BRIGHT DOT | $N \leq 2$ | $N \leq 2$ | $N \leq 7$ | |
| | | DARK DOT | $N \leq 3$ | $N \leq 4$ | | |
| | | TOTAL DOT | $N \leq 4$ | $N \leq 5$ | | |
| TWO ADJACENT DOT | NOT ALLOWED | | | | | |
| THREE OR MORE ADJACENT DOT | NOT ALLOWED | | | | | |
| External Inspection (non-operating) | Scratch on the polarizer | L(mm) | W(mm) | Acceptable number | Note:2 | |
| | | $L \leq 2.5$ | $W \leq 0.1$ | 4 | | |
| | | $L > 2.5$ | $W > 0.1$ | 0 | | |
| | Dent or bubble on the polarizer | Dimension(mm) | | Acceptable number | | Note:3 |
| | | $D \leq 0.5$ | | 4 | | |
| | | $D \leq 0.15$ | | Disregard | | |
| Foreign material on the polarizer | Dimension(mm) | | Acceptable number | | Note:3 | |
| | $D \leq 0.5$ | | 4 | | | |
| | $D \leq 0.15$ | | Disregard | | | |

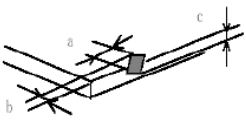
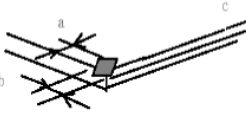
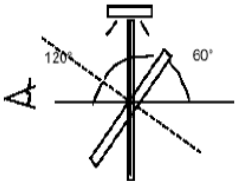

| Item | | Specification/Description | | | Note |
|----------------|---|---|---------------------|-------------------|--------|
| Touch Panel | Scratch | L(mm) | W(mm) | Acceptable number | Note:2 |
| | | $L \leq 10$ | $W < 0.05$ | Disregard | |
| | | | $0.05 \leq W < 0.1$ | $N \leq 4$ | |
| | | | $W \geq 0.1$ | 0 | |
| | Foreign Materials (Linear shape) | $L \leq 10$ | $W < 0.05$ | Disregard | Note:2 |
| | | | $0.05 \leq W < 0.1$ | $N \leq 3$ | |
| | | | $W \geq 0.1$ | 0 | |
| | Foreign Materials (Circular shape) | Dimension(mm) | | Acceptable number | Note:3 |
| | | $D \leq 0.25$ | | Disregard | |
| | | $0.25 < D \leq 0.5$ | | $N \leq 6$ | |
| Glass chipping |  | $a \leq 5\text{mm}$ | | Note:7 | |
| | | $b \leq 3\text{mm}$ | | | |
| Glass chipping |  | $a \leq 3\text{mm}$ | | Note:7 | |
| | | $b \leq 3\text{mm}$ | | | |
| Newton-ring | (In case of doubtful situations) Observe on 60° from the product surface under a white Fluorescent lamp(3-wavelength lamp). | Average diameter $\leq 1/3$ Touch Panel area Disregard. | | Note:7 | |
| | |  | | | |
| Membrane Drum |  | $H \leq 0.35\text{mm}$ | | | |



Note1. The definition of dot defect : The dot defect was judged after repair and the size of a defective dot over 1/2 of whole dot is regarded as one defective dot.

Note2.

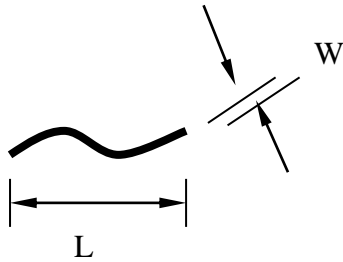

Note3. D : Diameter $D=(a+b)/2$

Note3. D : Diameter $D=(a+b)/2$

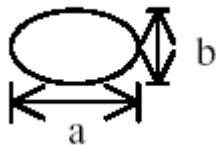

Note4. Bright dot is defined through 6% transmission ND Filter as following.

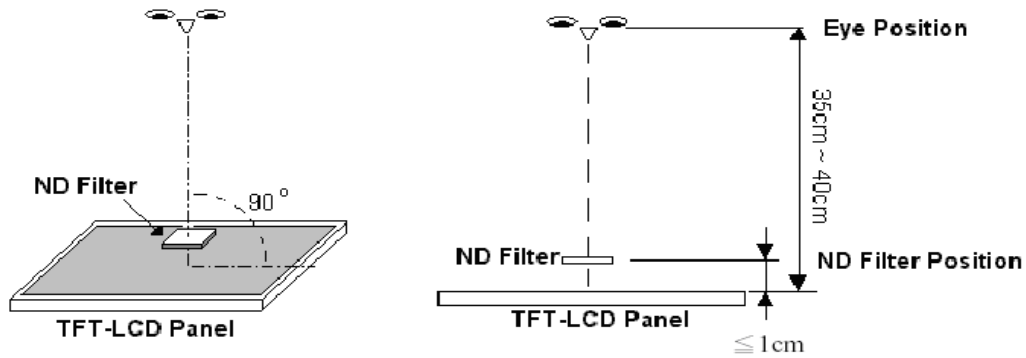

Note5. ADJACENT DOT





Note6.

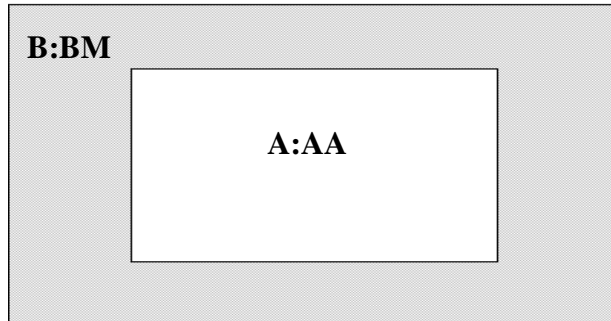

Note7.

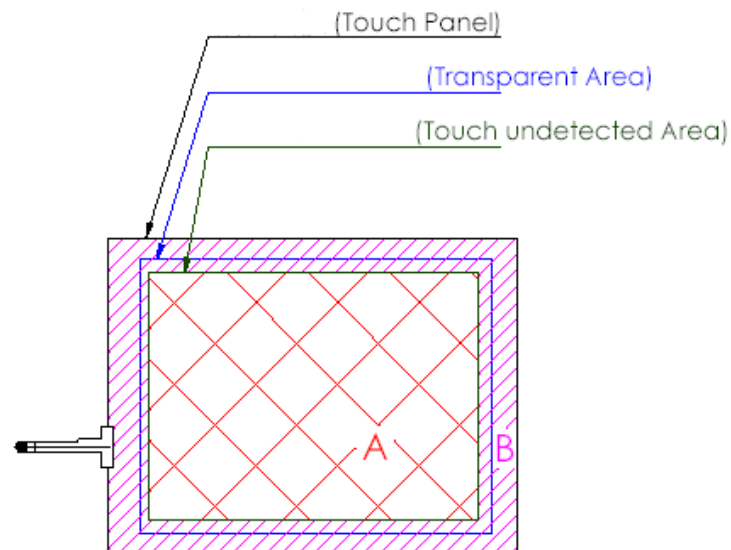

A area : Without any defect point effect on normal operation.

B area : None-specify

18.4 Handling of LCM

- (1) Don't give external shock.
- (2) Don't apply excessive force on the surface.
- (3) Liquid in LCD is hazardous substance. Must not lick and swallow. when the liquid is attach to your hand, skin, cloth etc. Wash it out thoroughly and immediately.
- (4) Don't operate it above the absolute maximum rating.
- (5) Don't disassemble the LCM.