

THIS DRAWING IS UNPUBLISHED.
 DIFFUSION RESTREINTE
 © COPYRIGHT 20

RELEASED FOR PUBLICATION
 LIBRE A LA DIFFUSION
 ALL RIGHTS RESERVED.
 TOUS DROITS RESERVES

REVISIONS					
P	LTR	DESCRIPTION MODIFICATIONS	DATE	DWN DESS.	APVD APP.
A		VUE AVEC LOGO TE	04MAY2009	P.B	-
B		0.9+0.15-0.05 ETAIT 0.9+-0.05	06JUL2011	PB	JP P

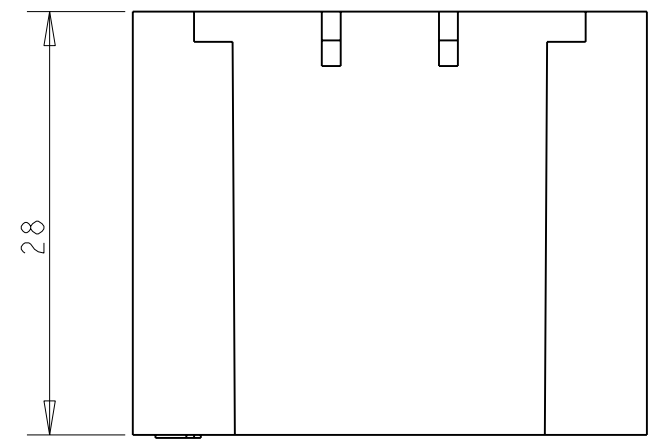
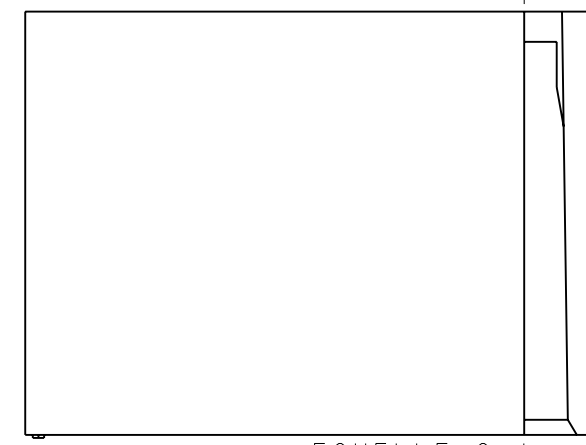
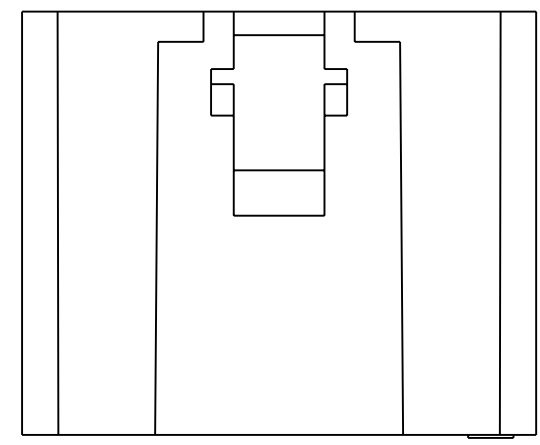
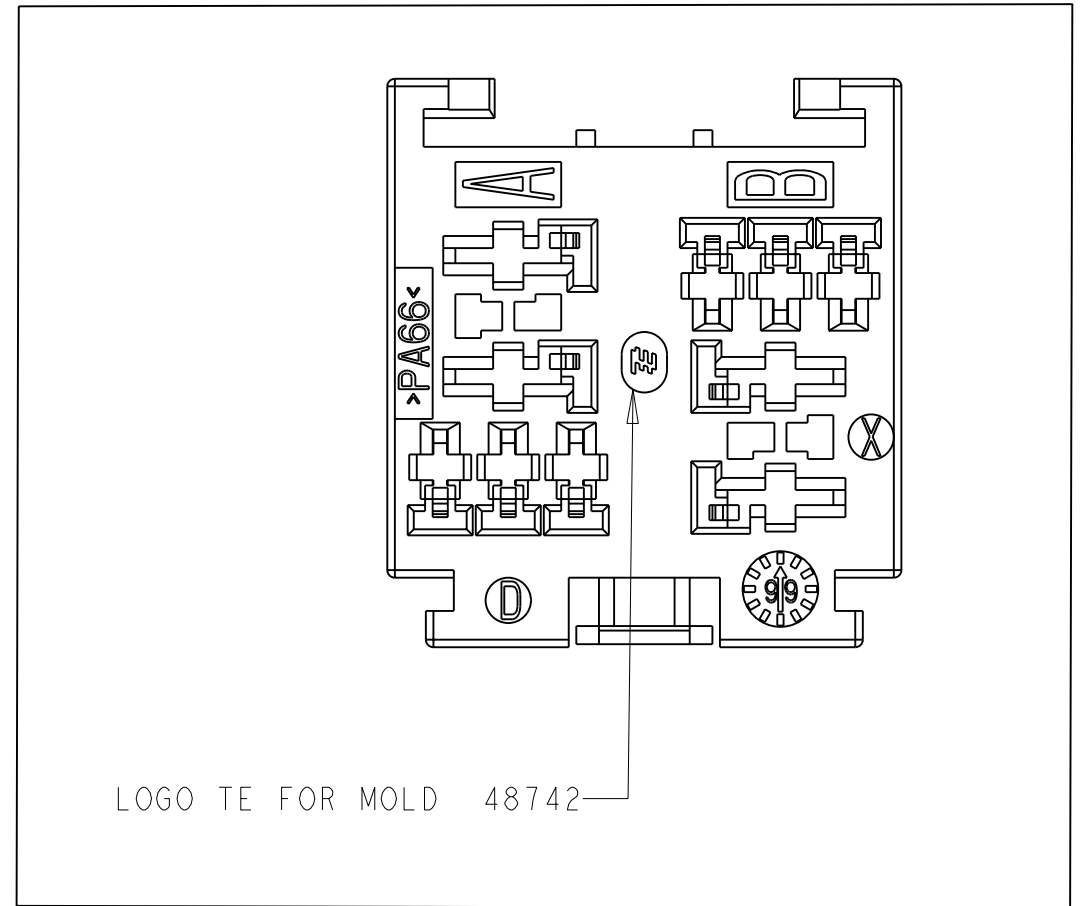
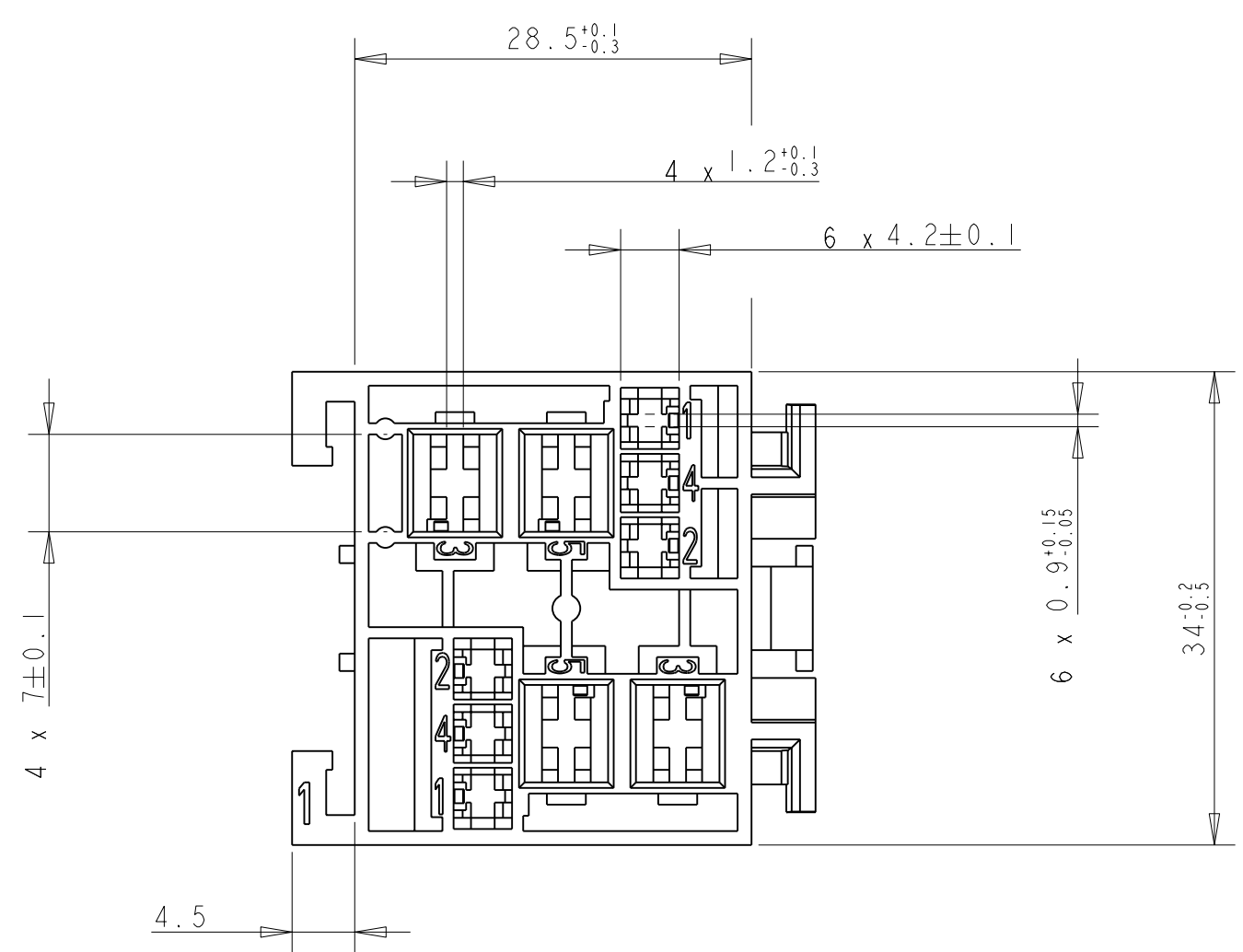

**COMPOSANTS ASSOCIES
 (APPLIED COMPONENTS)**

DESIGNATION (DESCRIPTION)	Ref TE (TE PN)
JPT 0.35-1mm ²	144431-1
JPT 1-3mm ²	144432-1
SPT 0.5-1mm ²	927831-2
SPT 1-3mm ²	144617-1
SPT 3-5mm ²	144433-1
SPT 5-7mm ²	144434-1

GRIS (GREY)	PA 6.6	185402-3
NOIR (BLACK)	PA 6.6	185402-2
CRISTAL (NATUREL) (CRYSTAL (NATURAL))	PA 6.6	185402-1
COULEUR (COLOR)	MATIERE (MATERIAL)	REF TE (TE PN)

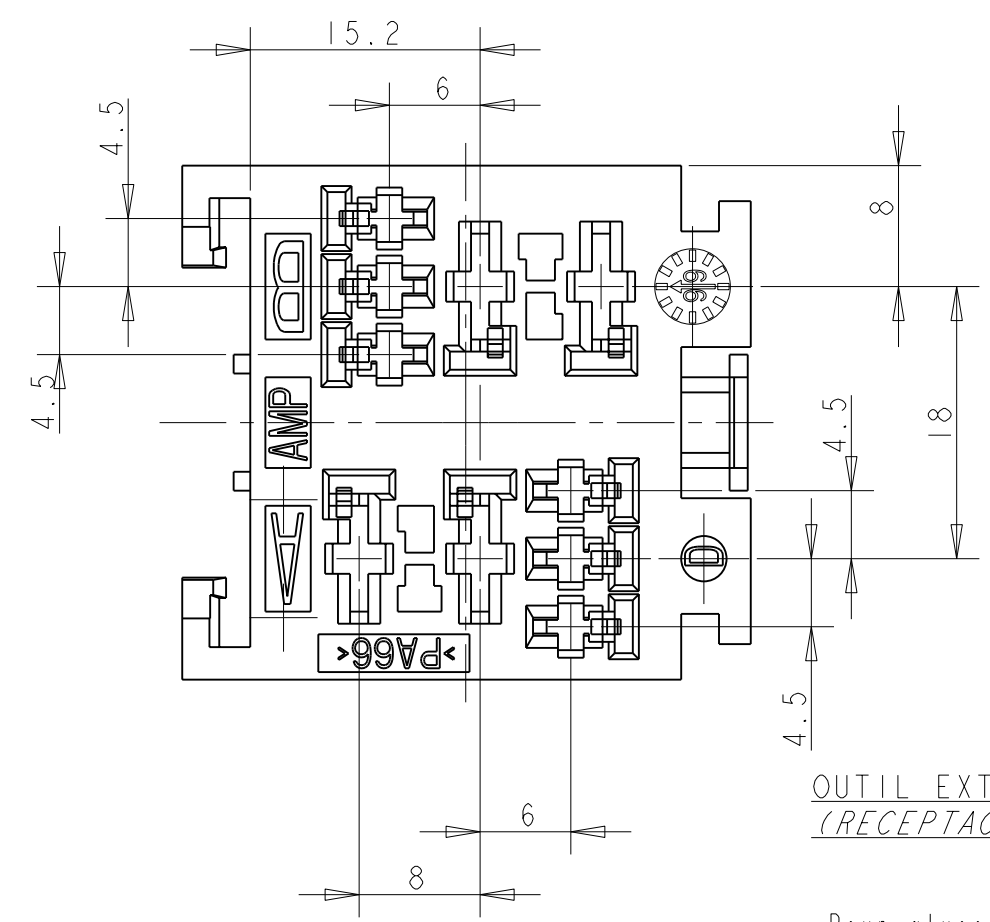

**OUTIL EXTRACTEUR DE CLIPS:
 (RECEPTACLE EXTRACTION TOOL)**

- Pour alveole Relais 2.8 Ref:951746-1
(FOR RELAY CAVITY)
- Pour alveole Relais 6.35 Ref:951745-1
(FOR RELAY CAVITY)

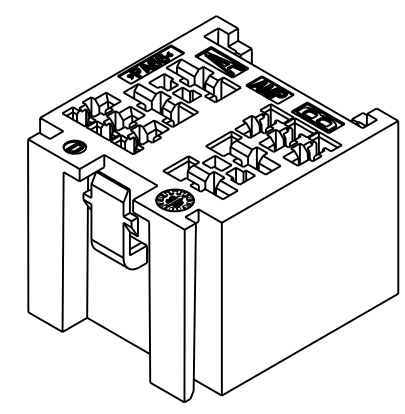

REFERENCE REPRESENTEE: 185402-1

THIS DRAWING IS A CONTROLLED DOCUMENT. <small>CE PLAN EST UN DOCUMENT CONTROLE PAR TYCO ELECTRONICS. IL EST SUSCEPTIBLE D'ETRE REVISE. CONTACTER LE SERVICE TECHNIQUE DE TYCO ELECTRONICS POUR OBTENIR LA DERNIERE REVISION.</small>		DWN /DESSINE 31MAR2004 R. PATIN		TE Connectivity	
DIMENSIONS: mm		CHK /VERIFIE 31MAR2004 JP. PICAUD			
TOLERANCES UNLESS OTHERWISE SPECIFIED: TOLERANCES NON SPECIFIEES (SUIV NB DE DECIMALES) 0 PLC/DEC: ± 1 PLC/DEC: ±0.2 2 PLC/DEC: ± 3 PLC/DEC: ± 4 PLC/DEC: ± ANGLES ±5°		APVD /APROUVE 31MAR2004 J. DAHER		NAME /TITRE MODULE UNITAIRE 2 MICRO-RELAIS	
MATERIAL /MATIERE VOIR TABLE		FINISH /FINITION VOIR TABLE		PRODUCT SPEC 108-15131 SPEC. PRODUIT APPLICATION SPEC 411-15551 SPEC. APPLICATION WEIGHT /MASSE APPROX. 16g CUSTOMER DRAWING /PLAN CLIENT	
1471-9 (3/11)		A2 00779		DRAWING NO No PLAN C-185402 CAGE CODE 00779 SCALE ECHELLE 2:1 SHEET FEUILLE 1 OF DE 1 RESTRICTED TO RESERVE A REV B	