

Hyper Mini SIDELED® Hyper-Bright LED

LS C876, LA C876
LO C876, LY C876

Besondere Merkmale

- Gehäusefarbe: weiß
- als optischer Indikator einsetzbar
- zur Hintergrundbeleuchtung, Lichtleiter- und Linseneinkopplung
- für alle SMT-Bestück- und Löttechniken geeignet
- gegurtet (8-mm-Filmgurt)

Features

- color of package: white
- for use as optical indicator
- for backlighting, optical coupling into light pipes and lenses
- suitable for all SMT assembly and soldering methods
- available taped on reel (8 mm tape)

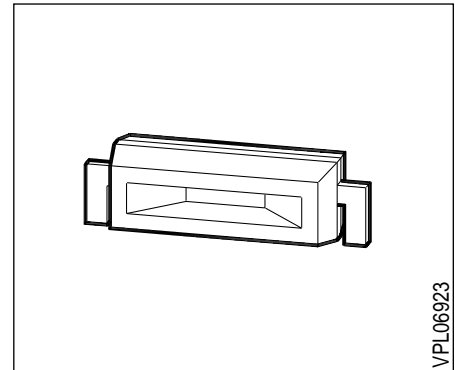

VPL06923

| Typ | Emissionsfarbe | Farbe der Lichtaustrittsfläche | Lichtstärke | Lichtstrom | Bestellnummer |
|------------|-------------------|----------------------------------|--|---|---------------|
| Type | Color of Emission | Color of the Light Emitting Area | Luminous Intensity $I_F = 20 \text{ mA}$ $I_V \text{ (mcd)}$ | Luminous Flux $I_F = 20 \text{ mA}$ $\Phi_V \text{ (lm)}$ | Ordering Code |
| LS C876-NO | super-red | colorless clear | ≥ 25 (60 typ.) | 180 (typ.) | Q62703-Q3659 |
| LA C876-PO | amber | colorless clear | ≥ 40 (100 typ.) | 300 (typ.) | Q62703-Q3658 |
| LO C876-PO | orange | colorless clear | ≥ 40 (100 typ.) | 300 (typ.) | Q62703-Q3657 |
| LY C876-PO | yellow | colorless clear | ≥ 40 (100 typ.) | 300 (typ.) | Q62703-Q3656 |

Streuung der Lichtstärke in einer Verpackungseinheit $I_{V \max} / I_{V \min} \leq 2.0$.
Luminous intensity ratio in one packaging unit $I_{V \max} / I_{V \min} \leq 2.0$.

Grenzwerte Maximum Ratings

| Bezeichnung Parameter | Symbol Symbol | Werte Values | | Einheit Unit |
|---|------------------|-----------------|----|-----------------|
| | | LS, LA, LO | LY | |
| Betriebstemperatur Operating temperature range | T_{op} | – 55... + 100 | | °C |
| Lagertemperatur Storage temperature range | T_{stg} | – 55... + 100 | | °C |
| Sperrschichttemperatur Junction temperature | T_j | + 100 | | °C |
| Durchlaßstrom Forward current | I_F | 30 | 20 | mA |
| Stoßstrom Surge current $t \leq 10 \mu s, D = 0.005$ | I_{FM} | to be defined | | A |
| Sperrspannung ¹⁾ ($I_F = 10 \mu A$) Reverse voltage ¹⁾ | V_R | 3 | | V |
| Verlustleistung Power dissipation, $T_A \leq 25 \text{ °C}$ | P_{tot} | 80 | 55 | mW |
| Wärmewiderstand Thermal resistance Sperrschicht / Umgebung Junction / air Montage auf PC-board ^{*)} (Padgröße $\geq 16 \text{ mm}^2$) mounted on PC board ^{*)} (pad size $\geq 16 \text{ mm}^2$) | R_{thJA} | 630 | | K/W |

1) Belastung in Sperrichtung sollte vermieden werden.

1) Reverse biasing should be avoided.

*) PC-board: FR4

Kennwerte ($T_A = 25 \text{ °C}$)

Characteristics

| Bezeichnung Parameter | Symbol Symbol | Werte Values | | | | Einheit Unit |
|---|-------------------------|-----------------|------------|------------|------------|--------------------------------|
| | | LS | LA | LO | LY | |
| Wellenlänge des emittierten Lichtes (typ.) Wavelength at peak emission (typ.) $I_F = 20 \text{ mA}$ | λ_{peak} | 645 | 622 | 610 | 591 | nm |
| Dominantwellenlänge (typ.) Dominant wavelength (typ.) $I_F = 20 \text{ mA}$ | λ_{dom} | 632 | 615 | 605 | 587 | nm |
| Spektrale Bandbreite bei 50% $I_{\text{rel max}}$ (typ.) Spectral bandwidth at 50% $I_{\text{rel max}}$ (typ.) $I_F = 20 \text{ mA}$ | $\Delta\lambda$ | 16 | 16 | 16 | 15 | nm |
| Abstrahlwinkel bei 50% I_v (Vollwinkel) Viewing angle at 50% I_v | 2ϕ | 120 | 120 | 120 | 120 | Grad deg. |
| Durchlaßspannung (typ.) Forward voltage (max.) $I_F = 20 \text{ mA}$ | V_F V_F | 2.0 2.6 | 2.0 2.6 | 2.0 2.6 | 2.0 2.6 | V V |
| Sperrstrom (typ.) Reverse current (max.) $V_R = 3 \text{ V}$ | I_R I_R | 0.01 10 | 0.01 10 | 0.01 10 | 0.01 10 | μA μA |
| Temperaturkoeffizient von λ_{dom} ($I_F = 20 \text{ mA}$) Temperature coefficient of λ_{dom} ($I_F = 20 \text{ mA}$) | TC_λ | 0.014 | 0.062 | 0.067 | 0.096 | nm/K |
| Temperaturkoeffizient von λ_{peak} , $I_F = 20 \text{ mA}$ (typ.) Temperature coefficient of λ_{peak} , $I_F = 20 \text{ mA}$ (typ.) | TC_λ | 0.14 | 0.13 | 0.13 | 0.13 | nm/K |
| Temperaturkoeffizient von V_F , $I_F = 20 \text{ mA}$ (typ.) Temperature coefficient of V_F , $I_F = 20 \text{ mA}$ (typ.) | TC_V | - 1.95 | - 1.78 | - 1.67 | - 2.51 | mV/K |

Relative spektrale Emission $I_{rel} = f(\lambda)$, $T_A = 25^\circ\text{C}$, $I_F = 10\text{ mA}$

Relative spectral emission

$V(\lambda)$ = spektrale Augenempfindlichkeit

Standard eye response curve

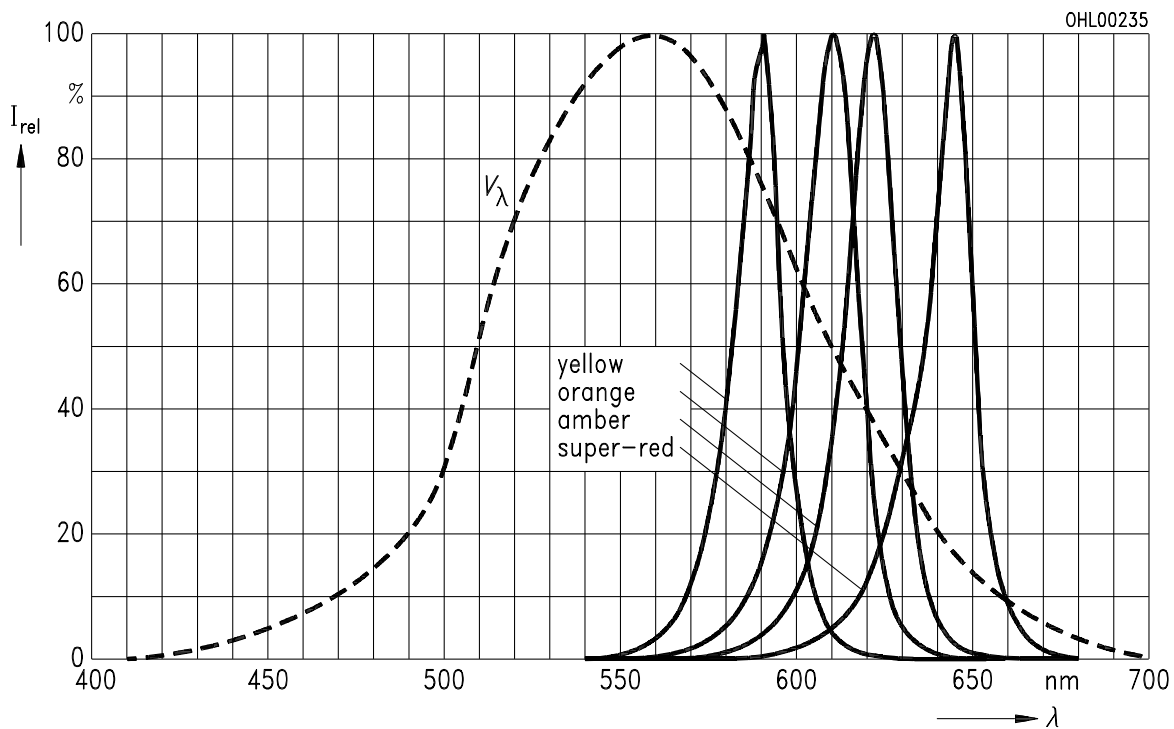

Abstrahlcharakteristik $I_{rel} = f(\varphi)$

Radiation characteristic

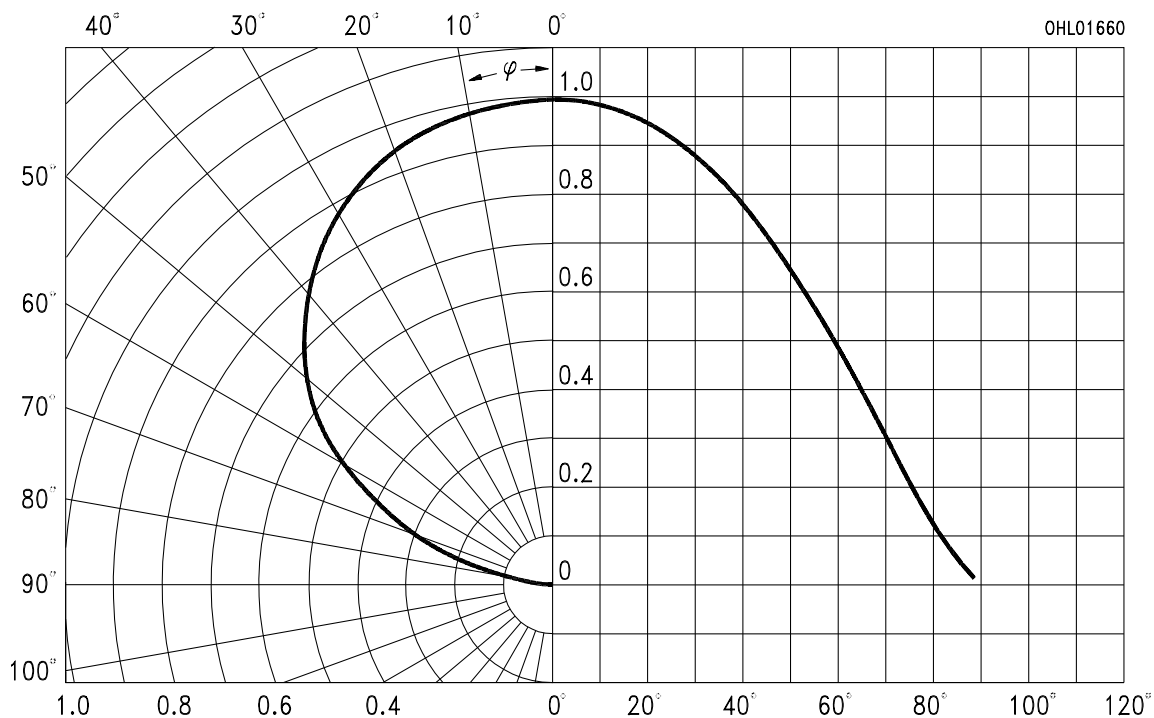

Durchlaßstrom $I_F = f(V_F)$

Forward current

$T_A = 25^\circ\text{C}$

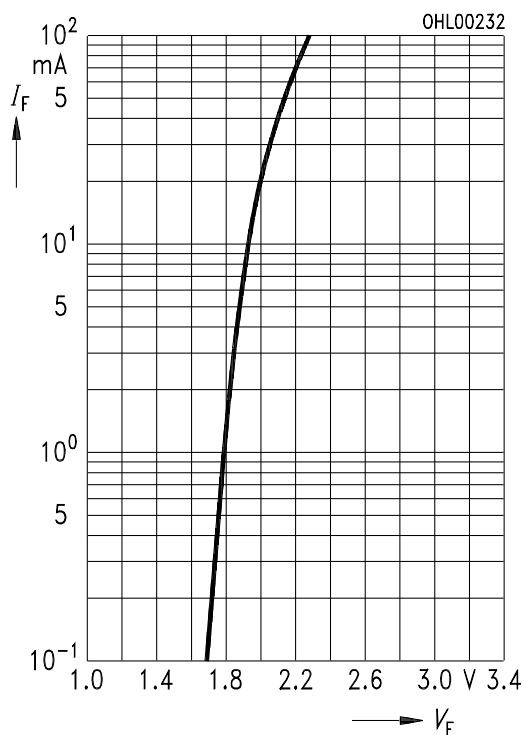

Maximal zulässiger Durchlaßstrom

Max. permissible forward current

$I_F = f(T_A)$

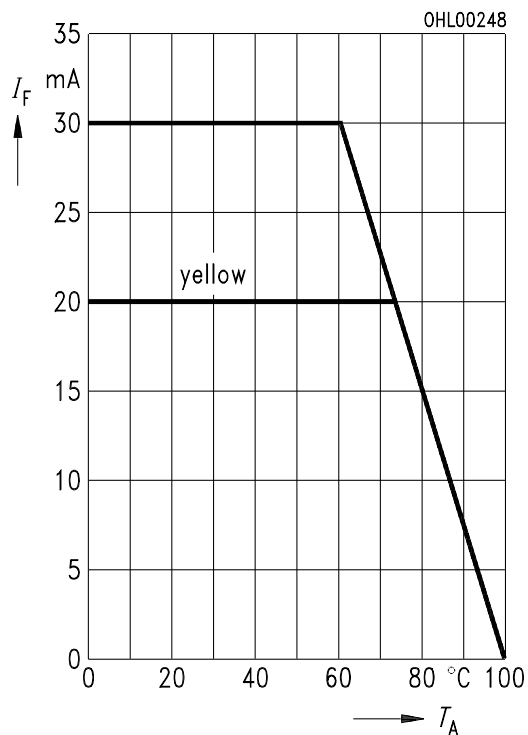

Relative Lichtstärke $I_V / I_{V(20\text{mA})} = f(I_F)$

Relative luminous intensity

$T_A = 25^\circ\text{C}$

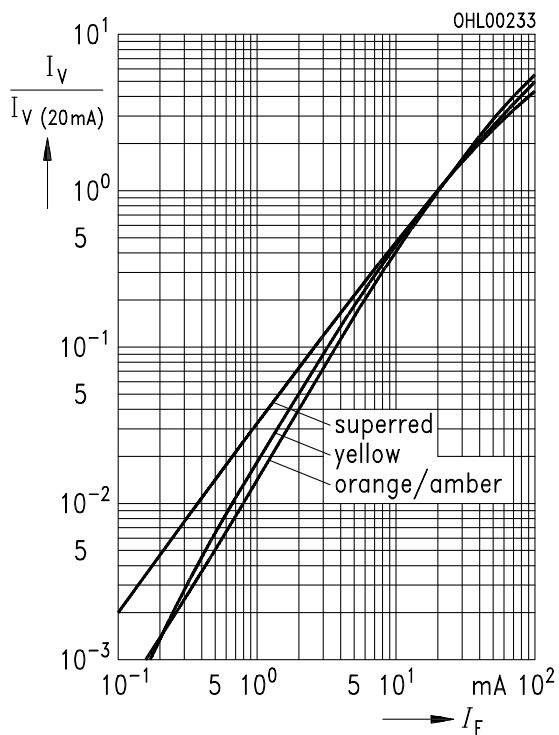

Relative Lichtstärke $I_V / I_{V(25^\circ\text{C})} = f(T_A)$

Relative luminous intensity

$I_F = 20\text{ mA}$

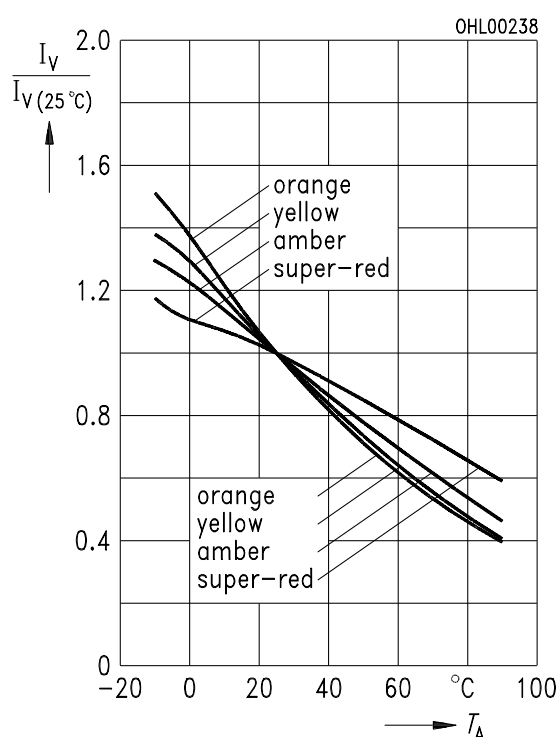

Zulässige Impulsbelastbarkeit $I_F = f(t_p)$
Permissible pulse handling capability
LS, LA, LO

Duty cycle $D =$ parameter, $T_A = 25\text{ °C}$

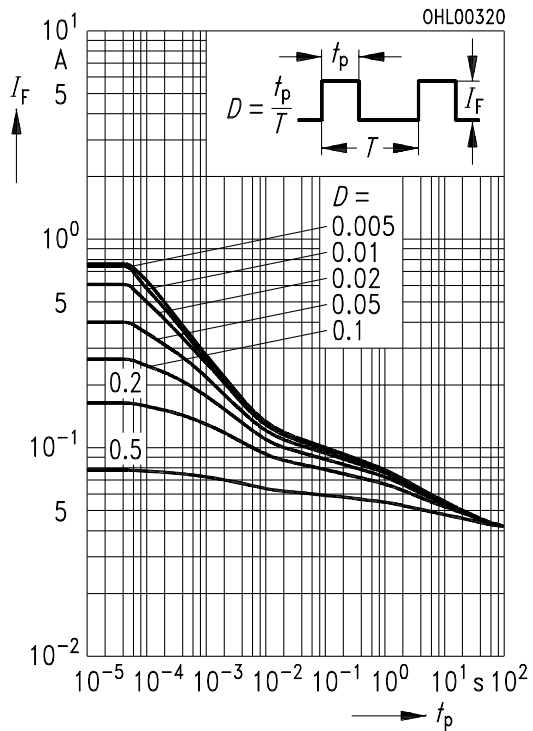

Zulässige Impulsbelastbarkeit $I_F = f(t_p)$
Permissible pulse handling capability
LY

Duty cycle $D =$ parameter, $T_A = 25\text{ °C}$

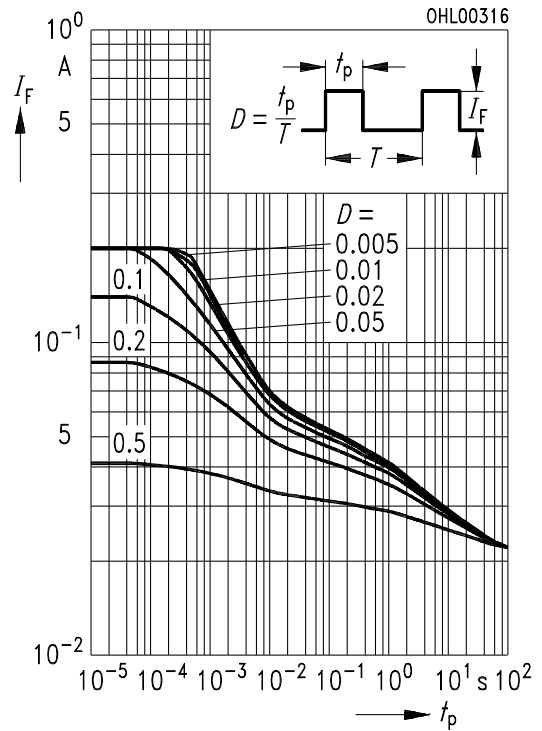

Maßzeichnung
Package Outlines

(Maße in mm, wenn nicht anders angegeben)
 (Dimensions in mm, unless otherwise specified)

