

MAX9879

Stereo Class D Audio Subsystem with DirectDrive Headphone Amplifier

General Description

The MAX9879 combines a high-efficiency stereo Class D audio power amplifier with a stereo capacitor-less DirectDrive® headphone amplifier. Maxim's filterless class D amplifiers with active emissions limiting technology provide Class AB performance with Class D efficiency.

The Class D power amplifier delivers up to 715mW from a 3.7V supply into an 8Ω load with 88% efficiency to extend battery life. The filterless modulation scheme combined with active emission limiting circuitry and spread-spectrum modulation greatly reduces EMI while eliminating the need for output filtering used in traditional Class D devices.

The headphone amplifier delivers up to 58mW from a 3.7V supply into a 16Ω load. Maxim's DirectDrive architecture produces a ground-referenced output from a single supply, eliminating the need for large DC-blocking capacitors, saving cost, space and component height.

The device utilizes a user-defined input architecture, three preamplifier gain settings, an input mixer, volume control, comprehensive click-and-pop suppression, and I²C control. A bypass mode feature disables the integrated Class D amplifier and utilizes an internal DPST switch to allow an external amplifier to drive the speaker that is connected at the outputs of the MAX9879.

The MAX9879 is available in a thermally efficient, space-saving 30-bump UCSP™ package.

Applications

Cell Phones Portable Multimedia Players

DirectDrive is a registered trademark of Maxim Integrated Products, Inc.

UCSP is a trademark of Maxim Integrated Products, Inc.

Simplified Block Diagram

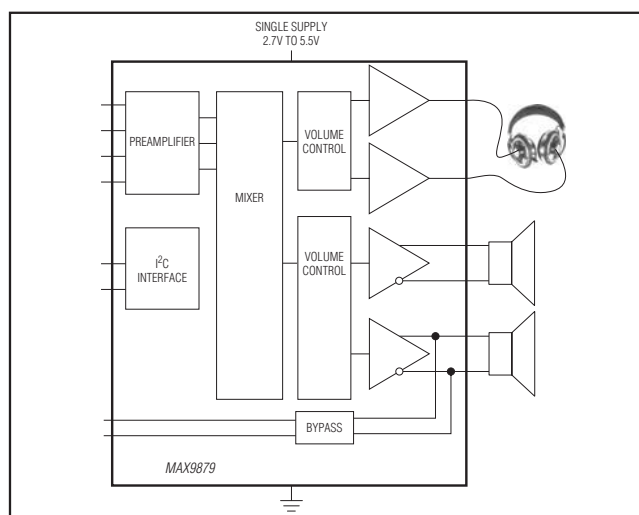

Features

- ◆ Better than 9dB Margin Under EN 55022 Class B Limits with No Filter Components
- ◆ Low RF Susceptibility Design Rejects TDMA Noise from GSM Radios
- ◆ Input Mixer with User Defined Input Mode
- ◆ Stereo 715mW Speaker Output ($R_L = 8\Omega$, $V_{DD} = 3.7V$)
- ◆ Stereo 58mW Headphone Output (16Ω, $V_{DD} = 3.7V$)
- ◆ Low 0.04% THD+N at 1kHz (Class D Power Amplifier)
- ◆ Low 0.018% THD+N at 1kHz (Headphone Amplifier)
- ◆ 88% Efficiency ($R_L = 8\Omega$, $P_{OUT} = 750mW$)
- ◆ 1.6Ω Analog Switch for Speaker Amplifier Bypass
- ◆ High Speaker Amplifier PSRR (72dB at 217Hz)
- ◆ High Headphone Amplifier PSRR (84dB at 217Hz)
- ◆ I²C Control
- ◆ Hardware and Software Shutdown Mode
- ◆ Ultra-Low Click and Pop
- ◆ Robust Design with Current and Thermal Protection
- ◆ Available in Space-Saving Package
5x6 UCSP (2.5mm x 3mm)

Ordering Information

PART	TEMP RANGE	PIN-PACKAGE
MAX9879ERV+	-40°C to +85°C	30 UCSP (5x6)

+Denotes a lead(Pb)-free/RoHS-compliant package.

Pin Configuration

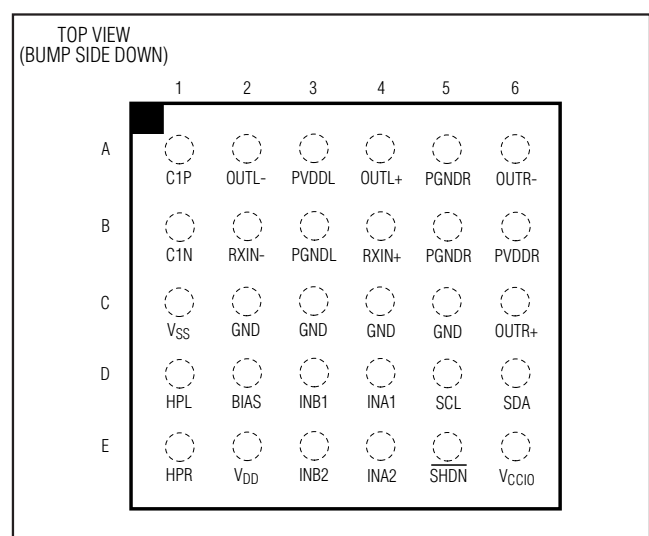

For pricing, delivery, and ordering information, please contact Maxim Direct at 1-888-629-4642, or visit Maxim's website at www.maximintegrated.com.

MAX9879

Stereo Class D Audio Subsystem with DirectDrive Headphone Amplifier

ABSOLUTE MAXIMUM RATINGS

V _{DD} , PVDDL, PVDDR to GND	-0.3V to +6V	Continuous Current In/Out of HPR and HPL	140mA
V _{DD} , PVDDL to PVDDR	-0.3V to +0.3V	Continuous Current In/Out of RXIN+ and RXIN-	150mA
V _{DD} to PVDDL	-0.3V to +0.3V	Continuous Input Current V _{SS}	100mA
V _{CCIO} to GND	-0.3V to +4V	Continuous Input Current (All Other Pins)	±20mA
PGNDL, PGNDR, to GND	-0.3V to +0.3V	Duration of OUT_ Short Circuit	
PGNDL to PGNDR	-0.3V to +0.3V	to PGND_ or PVDD_	Continuous
V _{SS} to GND	-6V to +0.3V	Duration of Short Circuit	
C1N to GND	(V _{SS} - 0.3V) to +0.3V	Between OUT_+ and OUT_-	Continuous
C1P to GND	-0.3V to (PVDD_ + 0.3V)	Duration of HP_ Short Circuit to GND or PVDDL	Continuous
HPL, HPR to V _{SS} (Note 1)	-0.3V to the lower of (V _{DD} - V _{SS} + 0.3V) or +9V	Continuous Power Dissipation (T _A = +70°C)	
HPL, HPR to V _{DD} (Note 2)	+0.3V to the higher of (V _{SS} - PVDD_ - 0.3V) or -9V	5x6 UCSP Multilayer Board (derate 16.5mW/°C above +70°C)	1250mW
INA1, INA2, INB1, INB2, BIAS	-0.3V to +4V	Junction Temperature	+150°C
SDA, SCL, SHDN	-0.3V to +4V	Operating Temperature Range	-40°C to +85°C
All Other Pins to GND	-0.3V to (PVDD_ + 0.3V)	Storage Temperature Range	-65°C to +150°C
Continuous Current In/Out of PVDD_, PGND_, OUT_	±800mA	Lead Temperature (soldering, 10s)	+300°C

Note 1: HPR and HPL should be limited to no more than 9V above V_{SS}, or above PV_{DD} + 0.3V, whichever limits first.

Note 2: HPR and HPL should be limited to no more than 9V below PV_{DD}, or below V_{SS} - 0.3V, whichever limits first.

Stresses beyond those listed under "Absolute Maximum Ratings" may cause permanent damage to the device. These are stress ratings only, and functional operation of the device at these or any other conditions beyond those indicated in the operational sections of the specifications is not implied. Exposure to absolute maximum rating conditions for extended periods may affect device reliability.

ELECTRICAL CHARACTERISTICS

(V_{DD} = VPVDDL = VPVDDR = 3.7V, V_{CCIO} = 1.8V, V_{GND} = VPGNDL = VPGNDR = 0. Single-ended inputs, preamp = 0, volume controls = 0dB, BYPASS = 0, SHDN = 1. Speaker loads connected between OUT_+ and OUT_-. Headphone loads connected from HPL or HPR to GND. R_{SPK} = ∞, R_{HP} = ∞. C1 = C2 = C_{BIAS} = 1μF. T_A = T_{MIN} to T_{MAX}, unless otherwise noted. Typical values are at T_A = +25°C.) (Notes 3, 4)

PARAMETER	SYMBOL	CONDITIONS	MIN	TYP	MAX	UNITS
Analog Supply Voltage Range	V _{DD} , PVDDR PVDDL	Guaranteed by PSRR Test	2.7		5.5	V
Digital Supply Voltage Range	V _{CCIO}		1.7		3.6	V
Quiescent Current	I _{DD}	HP mode, R _{HP} = ∞		5.6	9.0	mA
		Stereo SPK mode, R _{SPK} = ∞		9.8	18	
		Mono SPK mode, R _{SPK} = ∞		6.6	10	
		Stereo SPK + HP mode, R _{HP} = R _{SPK} = ∞		13.2	24	
Shutdown Current	I _{SHDN}	I _{SHDN} = I _{DD} + I _{PVDDR} + I _{PVDDL} + I _{CC} ; T _A = +25°C	Software shutdown	5	10	μA
			Hardware shutdown	0.1	1	
Turn-On Time	t _{ON}	Time from shutdown or power-on to full operation		10		ms
Input Resistance	R _{IN}	T _A = +25°C, preamp = 0dB or +5.5dB	11	21	31	kΩ
		T _A = +25°C, preamp = +20dB	3	5.5	8	
Maximum Input Signal Swing	Headphone amplifier path	Preamp = 0dB		2.3		V _{P-P}
		Preamp = +5.5dB		1.2		
		Preamp = +20dB		0.23		
	Speaker amplifier path	Preamp = 0dB		1.2		
		Preamp = +5.5dB		0.64		
		Preamp = +20dB		0.12		

Stereo Class D Audio Subsystem with DirectDrive Headphone Amplifier

ELECTRICAL CHARACTERISTICS (continued)

($V_{DD} = V_{PVDDL} = V_{PVDDR} = 3.7V$, $V_{CCIO} = 1.8V$, $V_{GND} = V_{PGNDL} = V_{PGNDR} = 0$. Single-ended inputs, preamp = 0, volume controls = 0dB, BYPASS = 0, SHDN = 1. Speaker loads connected between OUT_+ and OUT_-. Headphone loads connected from HPL or HPR to GND. $R_{SPK} = \infty$, $R_{HP} = \infty$. $C1 = C2 = C_{BIAS} = 1\mu F$. $T_A = T_{MIN}$ to T_{MAX} , unless otherwise noted. Typical values are at $T_A = +25^\circ C$.) (Notes 3, 4)

PARAMETER	SYMBOL	CONDITIONS		MIN	TYP	MAX	UNITS
Common-Mode Rejection Ratio	CMRR	$f_{IN} = 1kHz$ (differential input mode)	Preamp = 0		58		dB
			Preamp = 5.5dB		55		
			Preamp = 20dB		43		
Input DC Voltage		IN__ inputs	1.22	1.3	1.38	V	
Bias Voltage	V_{BIAS}		1.13	1.2	1.272	V	
SPEAKER AMPLIFIER							
Output Offset Voltage	VOS	$T_A = +25^\circ C$ (volume at mute)		± 0.5	± 4		mV
		$T_A = +25^\circ C$ (volume at 0dB, ENA = 1 and ENB = 0 or ENB = 1 and ENA = 0, $\Delta IN_- = 0$)			± 4.5		mV
Click-and-Pop Level	KCP	Peak voltage, $T_A = +25^\circ C$ A-weighted, 32 samples per second, volume at mute (Note 5)	Into shutdown		-70		dBV
			Out of shutdown		-70		
Power-Supply Rejection Ratio (Note 5)	PSRR	$T_A = +25^\circ C$	$PVDD_- = V_{DD} = 2.7V$ to $5.5V$	50	76		dB
			$f = 217Hz$, 100mV _{P-P} ripple		72		
			$f = 1kHz$, 100mV _{P-P} ripple		68		
			$f = 20kHz$, 100mV _{P-P} ripple		55		
Output Power	P_{OUT}	THD+N $\leq 1\%$, $R_{SPK} = 8\Omega$	$V_{DD} = 3.7V$		715		mW
			$V_{DD} = 3.3V$		565		
			$V_{DD} = 3.0V$		470		
Total Harmonic Distortion + Noise	THD+N	$f = 1kHz$, $P_{OUT} = 350mW$, $T_A = +25^\circ C$, $R_{SPK} = 8\Omega$		0.04	0.2		%
Signal-to-Noise Ratio	SNR	A-weighted, ENA = 1 and ENB = 0 or ENB = 1 and ENA = 0	$\Delta IN_- = 0$ (single-ended)		92		dB
			$\Delta IN_- = 1$ (differential)		94		
		A-weighted ENA = ENB = 1	$\Delta IN_- = 0$ (single-ended)		88		
			$\Delta IN_- = 1$ (differential)		92		
Output Frequency				700	± 40		kHz

MAX9879

Stereo Class D Audio Subsystem with DirectDrive Headphone Amplifier

ELECTRICAL CHARACTERISTICS (continued)

($V_{DD} = V_{PVDDL} = V_{PVDDR} = 3.7V$, $V_{CCIO} = 1.8V$, $V_{GND} = V_{PGNDL} = V_{PGNDR} = 0$. Single-ended inputs, preamp = 0, volume controls = 0dB, BYPASS = 0, SHDN = 1. Speaker loads connected between OUT_+ and OUT_-. Headphone loads connected from HPL or HPR to GND. $R_{SPK} = \infty$, $R_{HP} = \infty$. $C1 = C2 = C_{BIAS} = 1\mu F$. $T_A = T_{MIN}$ to T_{MAX} , unless otherwise noted. Typical values are at $T_A = +25^\circ C$.) (Notes 3, 4)

PARAMETER	SYMBOL	CONDITIONS	MIN	TYP	MAX	UNITS
Current Limit				1.5		A
Efficiency	η	$P_{OUT} = 600mW$, $f = 1kHz$		88		%
Speaker Gain	A_V		17.4	18	18.4	dB
Output Noise		A-weighted, (ENA = 1 and ENB = 0 or ENA = 0 and ENB = 1), $\Delta IN_- = 0$		63		μV_{RMS}
Crosstalk		OUTL to OUTR, OUTR to OUTL, $f = 20Hz$ to $20kHz$		75		dB
HEADPHONE AMPLIFIERS						
Output Offset Voltage	V_{OS}	$T_A = +25^\circ C$ (volume at mute)		± 0.22	± 0.85	mV
		$T_A = +25^\circ C$ (Volume at 0dB, ENA = 1 and ENB = 0 or ENA = 0 and ENB = 1, $\Delta IN_- = 0$)		± 1.5		mV
Click-and-Pop Level	K_{CP}	Peak voltage, $T_A = 25^\circ C$ A-weighted, 32 samples per second, volume at mute (Note 5)	Into shutdown		-75	dBV
			Out of shutdown		-75	
Power-Supply Rejection Ratio (Note 5)	PSRR	$T_A = +25^\circ C$	$PVDD_- = V_{DD} = 2.7V$ to $5.5V$	70	85	dB
			$f = 217Hz$, $V_{RIPPLE} = 100mV_{P-P}$		84	
			$f = 1kHz$, $V_{RIPPLE} = 100mV_{P-P}$		80	
			$f = 20kHz$, $V_{RIPPLE} = 100mV_{P-P}$		62	
Output Power	P_{OUT}	THD+N = 1%	$R_{HP} = 16\Omega$		58	mW
			$R_{HP} = 32\Omega$		54	
Headphone Gain	A_V		2.6	3	3.4	dB
Channel-to-Channel Gain Tracking		$T_A = +25^\circ C$, HPL to HPR, volume at 0dB, ENA=1 and ENB = 0 or ENA = 1 and ENB = 0, $\Delta IN_- = 0$		± 0.3	± 2.5	%
Total Harmonic Distortion + Noise	THD+N	$R_{HP} = 32\Omega$ ($P_{OUT} = 10mW$, $f = 1kHz$)		0.018		%
		$R_{HP} = 16\Omega$ ($P_{OUT} = 10mW$, $f = 1kHz$)		0.037	0.08	

Stereo Class D Audio Subsystem with DirectDrive Headphone Amplifier

ELECTRICAL CHARACTERISTICS (continued)

($V_{DD} = V_{PVDDL} = V_{PVDDR} = 3.7V$, $V_{CCIO} = 1.8V$, $V_{GND} = V_{PGNDL} = V_{PGNDR} = 0$. Single-ended inputs, preamp = 0, volume controls = 0dB, BYPASS = 0, SHDN = 1. Speaker loads connected between OUT_+ and OUT_-. Headphone loads connected from HPL or HPR to GND. $R_{SPK} = \infty$, $R_{HP} = \infty$. $C1 = C2 = C_{BIAS} = 1\mu F$. $T_A = T_{MIN}$ to T_{MAX} , unless otherwise noted. Typical values are at $T_A = +25^\circ C$.) (Notes 3, 4)

PARAMETER	SYMBOL	CONDITIONS		MIN	TYP	MAX	UNITS
Signal-to-Noise Ratio	SNR	A-weighted, $R_{HP} = 16\Omega$	ENA = 1 and ENB = 0 or ENA = 1 and ENB = 0	$\Delta IN_- = 0$	98		dB
				$\Delta IN_- = 1$	98		
			ENA = 1 and ENB = 1	$\Delta IN_- = 0$	96		
				$\Delta IN_- = 1$	96		
Slew Rate	SR			0.35			V/ μs
Capacitive Drive	C_L				100		pF
Crosstalk			HPL to HPR, HPR to HPL, $f = 20Hz$ to $20kHz$		67		dB
Charge-Pump Frequency					350	± 20	kHz
VOLUME CONTROL							
Minimum Setting			$_VOL = 1$		-75		dB
Maximum Setting			$_VOL = 31$		0		dB
Input Gain		Input A or B		PGAIN_ = 00	0		dB
				PGAIN_ = 01	5.5		
				PGAIN_ = 10	20		
Mute Attenuation		$f = 1kHz$, $_VOL = 0$		Speaker	100		dB
				Headphone	110		
Zero-Crossing Detection Time Out			ZCD = 1		60		ms
ANALOG SWITCH							
On-Resistance	R_{ON}	$I_{RXIN_-} = 20mA$, $RXIN_- = 0$ and V_{DD} , BYPASS = 1		$T_A = +25^\circ C$	2.4	4	Ω
				$T_A = T_{MIN}$ to T_{MAX}		5.2	
Total Harmonic Distortion + Noise		$V_{DIFRXIN} = 2V_{P-P}$, $V_{CMRXIN} = V_{DD}/2$, $f = 1kHz$, BYPASS = 1		Series resistance is 10Ω per switch	0.3	0.25	%
				No series resistors	0.3		
Off-Isolation			BYPASS = 0, $RXIN+$ and $RXIN-$ to GND = 50Ω , $R_{SPK} = 8\Omega$, $f = 10kHz$, referred to speaker output signal		88		dB
DIGITAL INPUTS (SDA, SCL, SHDN)							
Input Voltage High (SDA, SCL)	V_{IH}				$0.7 \times V_{CCIO}$		V
Input Voltage Low (SDA, SCL)	V_{IL}					$0.3 \times V_{CCIO}$	V
Input Hysteresis (SDA, SCL)	V_{HYS}				200		mV

MAX9879

Stereo Class D Audio Subsystem with DirectDrive Headphone Amplifier

ELECTRICAL CHARACTERISTICS (continued)

($V_{DD} = V_{PVDDL} = V_{PVDDR} = 3.7V$, $V_{CCIO} = 1.8V$, $V_{GND} = V_{PGNDL} = V_{PGNDR} = 0$. Single-ended inputs, preamp = 0, volume controls = 0dB, BYPASS = 0, SHDN = 1. Speaker loads connected between OUT_+ and OUT_-. Headphone loads connected from HPL or HPR to GND. $R_{SPK} = \infty$, $R_{HP} = \infty$. $C_1 = C_2 = C_{BIAS} = 1\mu F$. $T_A = T_{MIN}$ to T_{MAX} , unless otherwise noted. Typical values are at $T_A = +25^\circ C$.) (Notes 3, 4)

PARAMETER	SYMBOL	CONDITIONS	MIN	TYP	MAX	UNITS
Input Voltage High (SHDN)	V_{IH}		1.4			V
Input Voltage Low (SHDN)	V_{IL}				0.4	V
Input Hysteresis (SHDN)	V_{HYS}			100		mV
SDA, SCL, SHDN Input Capacitance	C_{IN}			10		pF
Input Leakage Current	I_{IN}	SDA, SCL, SHDN, $T_A = +25^\circ C$			± 1.0	μA
Input Leakage Current	I_{IN}	$V_{CCIO} = 0$, $T_A = +25^\circ C$			± 1.0	μA
DIGITAL OUTPUTS (SDA open drain)						
Output Low-Voltage SDA	V_{OL}	$I_{SINK} = 3mA$			0.4	V
Output High-Voltage SDA	V_{OH}	$I_{SINK} = 3mA$	$V_{CCIO} - 0.4$			V
Output Fall Time SDA	t_{OF}	$V_{H(MIN)}$ to $V_{L(MAX)}$ bus capacitance = 10pF to 400pF, $I_{SINK} = 3mA$			250	ns
2-WIRE INTERFACE TIMING						
External Pullup Voltage Range (SDA and SCL)			1.7		3.6	V
Serial-Clock Frequency	f_{SCL}		DC		400	kHz
Bus Free Time Between STOP and START Conditions	t_{BUF}		1.3			μs
START Condition Hold	$t_{HD:STA}$		0.6			μs
START Condition Setup Time	$t_{SU:STA}$		0.6			μs
Clock Low Period	t_{LOW}		1.3			μs
Clock High Period	t_{HIGH}		0.6			μs
Data Setup Time	$t_{SU:DAT}$		100			ns
Data Hold Time	$t_{HD:DAT}$		0		900	ns
SCL/SDA Receiving Rise Time	t_R	(Note 6)	$20 + 0.1 \times C_B$		300	ns
SCL/SDA Receiving Fall Time	t_F		$20 + 0.1 \times C_B$		300	ns
SDA Transmitting Fall Time	t_F	$V_{CCIO} = 1.8V$ (Note 6)	$20 + 0.1 \times C_B$		250	ns
		$V_{CCIO} = 3.6V$ (Note 6)	$20 + 0.05 \times C_B$		250	

MAX9879

Stereo Class D Audio Subsystem with DirectDrive Headphone Amplifier

ELECTRICAL CHARACTERISTICS (continued)

($V_{DD} = V_{PVDDL} = V_{PVDDR} = 3.7V$, $V_{CCIO} = 1.8V$, $V_{GND} = V_{PGNDL} = V_{PGNDR} = 0$. Single-ended inputs, preamp = 0dB, volume controls = 0dB, BYPASS = 0, SHDN = 1. Speaker loads connected between OUT_+ and OUT_-. Headphone loads connected from HPL or HPR to GND. $R_{SPK} = \infty$, $R_{HP} = \infty$. $C1 = C2 = C_{BIAS} = 1\mu F$. $T_A = T_{MIN}$ to T_{MAX} , unless otherwise noted. Typical values are at $T_A = +25^\circ C$.) (Notes 3, 4)

PARAMETER	SYMBOL	CONDITIONS	MIN	TYP	MAX	UNITS
Set-Up Time for STOP Condition	$t_{SU:STO}$		0.6			μs
Pulse Width of Spike Suppressed	t_{SP}		0		50	ns
Capacitive Load for Each Bus Line	C_B				400	pF

Note 3: All devices are 100% production tested at $T_A = +25^\circ C$. All temperature limits are guaranteed by design.

Note 4: Class D amplifier testing performed with a resistive load in series with an inductor to simulate an actual speaker load. For $R_{SPKR} = 8\Omega$, $L = 68mH$.

Note 5: Amplifier inputs are AC-coupled to GND.

Note 6: C_B is in pF.

MAX9879

Stereo Class D Audio Subsystem with DirectDrive Headphone Amplifier

Typical Operating Characteristics

($V_{DD} = V_{PVDDL} = V_{PVDDR} = 3.7V$, $V_{CCIO} = 1.8V$, $V_{GND} = V_{PGNDL} = V_{PGNDR} = 0$. Single-ended inputs, preamp = 0dB, volume controls = 0dB, BYPASS = 0, SHDN = 1. Speaker loads connected between OUT_+ and OUT_-. Headphone loads connected from HPL or HPR to GND. $R_{SPK} = \infty$, $R_{HP} = \infty$. $C_1 = C_2 = C_{BIAS} = 1\mu F$. $T_A = +25^\circ C$, unless otherwise noted.)

GENERAL

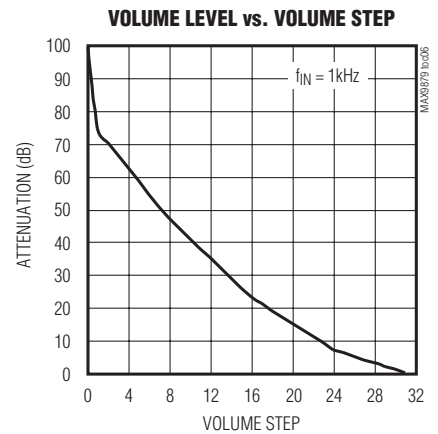
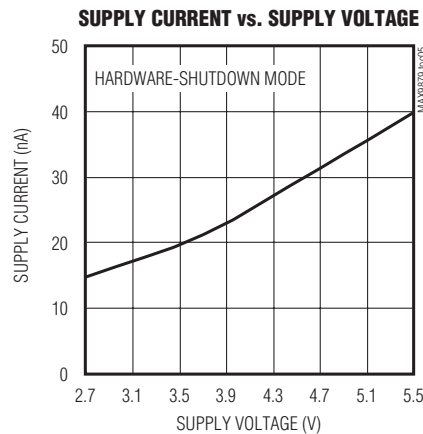
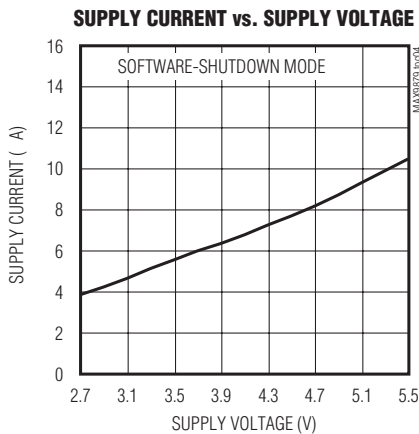
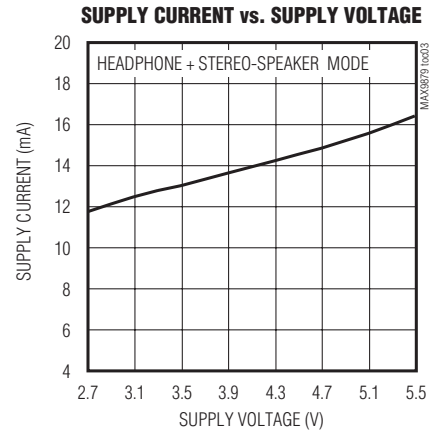
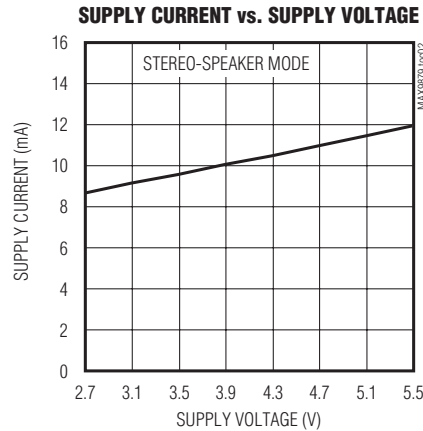
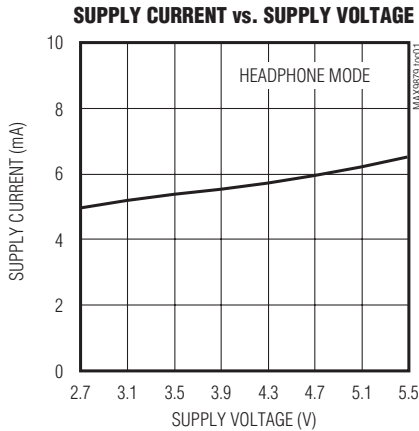

Stereo Class D Audio Subsystem with DirectDrive Headphone Amplifier

Typical Operating Characteristics (continued)

($V_{DD} = V_{PVDDL} = V_{PVDDR} = 3.7V$, $V_{CCIO} = 1.8V$, $V_{GND} = V_{PGNDL} = V_{PGNDR} = 0$. Single-ended inputs, preamp = 0dB, volume controls = 0dB, BYPASS = 0, SHDN = 1. Speaker loads connected between OUT₊ and OUT₋. Headphone loads connected from HPL or HPR to GND. $R_{SPK} = \infty$, $R_{HP} = \infty$. $C1 = C2 = C_{BIAS} = 1\mu F$. $T_A = +25^\circ C$, unless otherwise noted.)

SPEAKER AMPLIFIERS (Headphone Disabled)

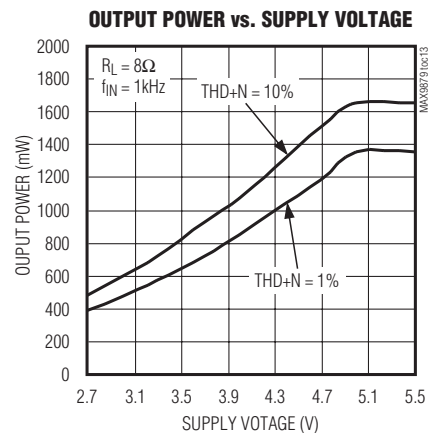
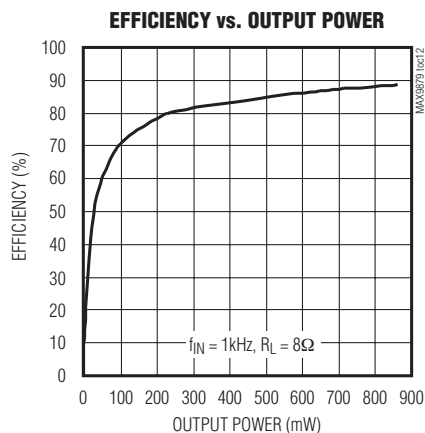
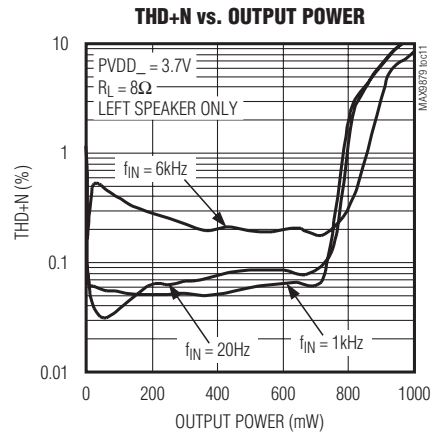
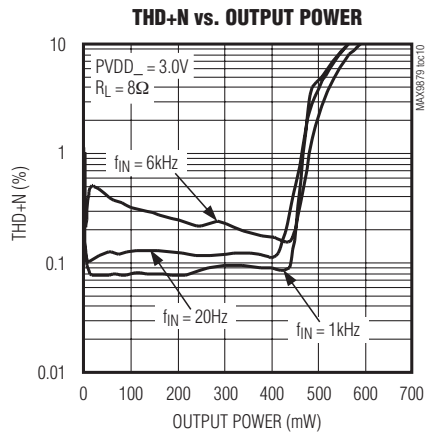
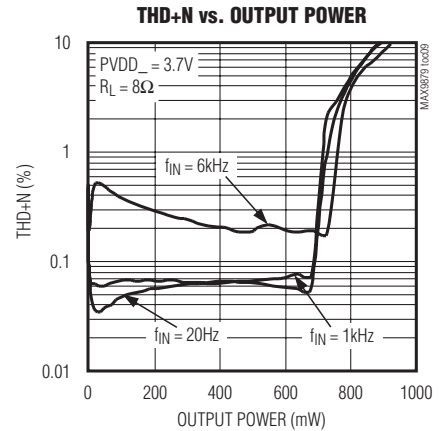
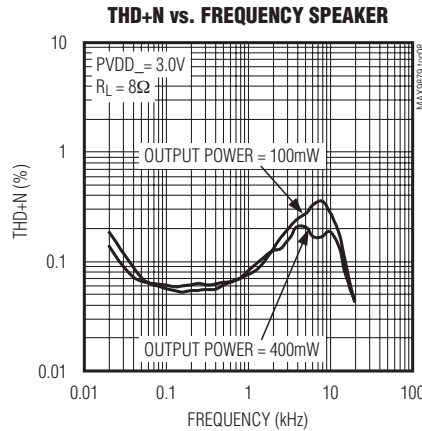
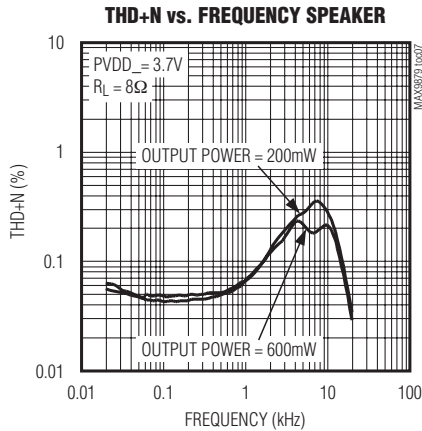

MAX9879

Stereo Class D Audio Subsystem with DirectDrive Headphone Amplifier

Typical Operating Characteristics (continued)

($V_{DD} = V_{PVDDL} = V_{PVDDR} = 3.7V$, $V_{CCIO} = 1.8V$, $V_{GND} = V_{PGNDL} = V_{PGNDR} = 0$. Single-ended inputs, preamp = 0dB, volume controls = 0dB, BYPASS = 0, SHDN = 1. Speaker loads connected between OUT₊ and OUT₋. Headphone loads connected from HPL or HPR to GND. $R_{SPK} = \infty$, $R_{HP} = \infty$. $C1 = C2 = C_{BIAS} = 1\mu F$. $T_A = +25^\circ C$, unless otherwise noted.)

SPEAKER AMPLIFIERS (Headphone Disabled)

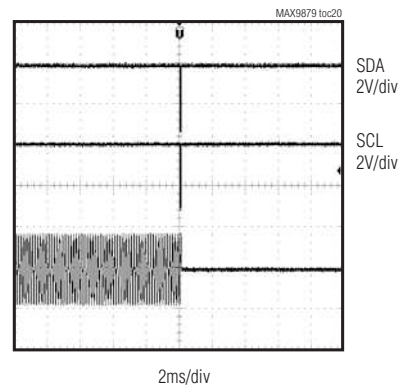
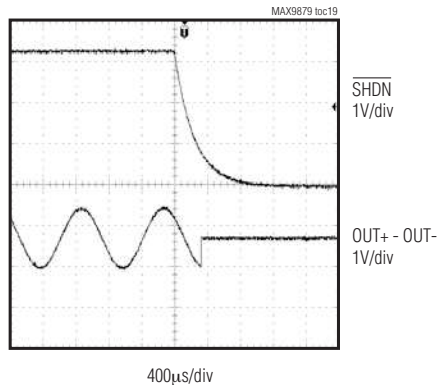
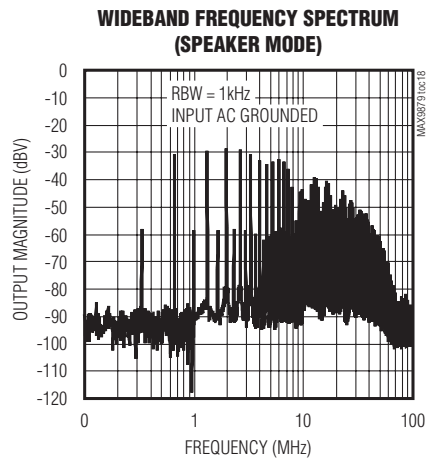
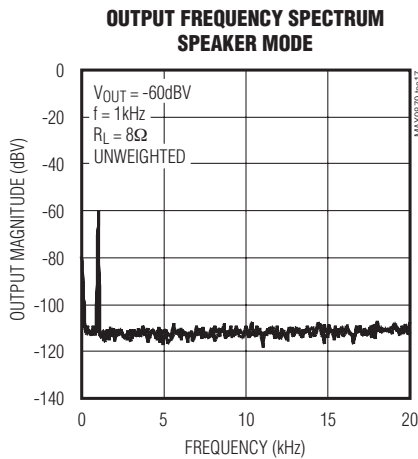
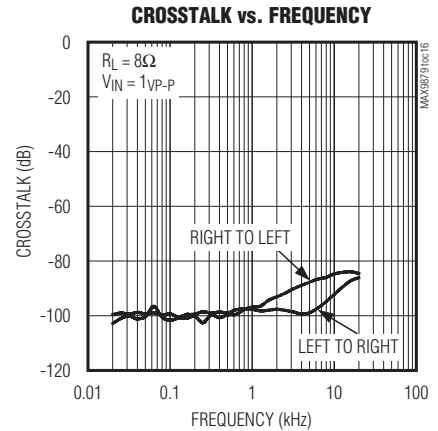
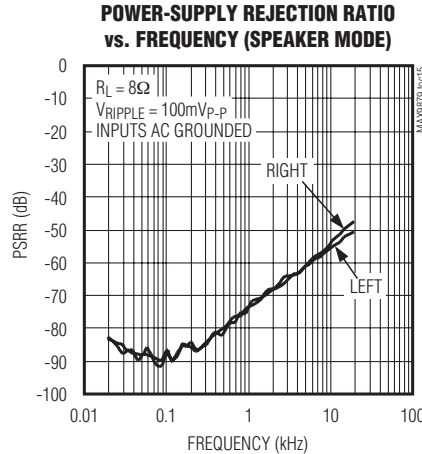
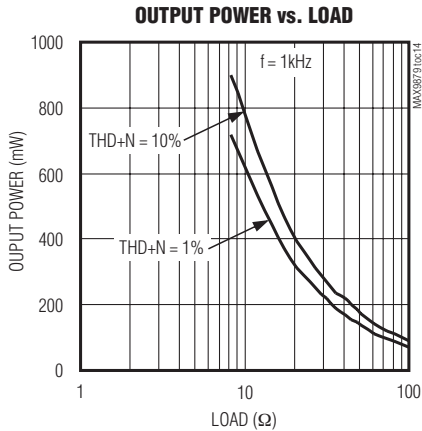

Stereo Class D Audio Subsystem with DirectDrive Headphone Amplifier

Typical Operating Characteristics (continued)

($V_{DD} = V_{PVDDL} = V_{PVDDR} = 3.7V$, $V_{CCIO} = 1.8V$, $V_{GND} = V_{PGNDL} = V_{PGNDR} = 0$. Single-ended inputs, preamp = 0dB, volume controls = 0dB, BYPASS = 0, SHDN = 1. Speaker loads connected between OUT_+ and OUT_-. Headphone loads connected from HPL or HPR to GND. $R_{SPK} = \infty$, $R_{HP} = \infty$. $C1 = C2 = C_{BIAS} = 1\mu F$. $T_A = +25^\circ C$, unless otherwise noted.)

HEADPHONE AMPLIFIERS (Speaker Disabled)

TOTAL HARMONIC DISTORTION + NOISE vs. FREQUENCY (HEADPHONE MODE)

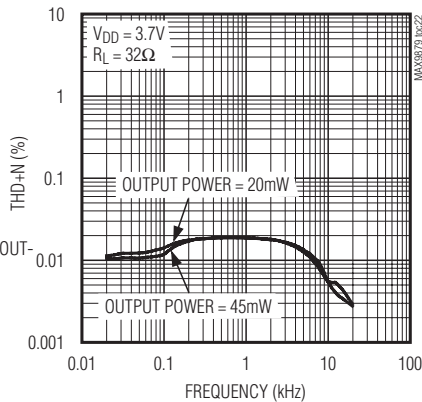

TOTAL HARMONIC DISTORTION + NOISE vs. FREQUENCY (HEADPHONE NOISE)

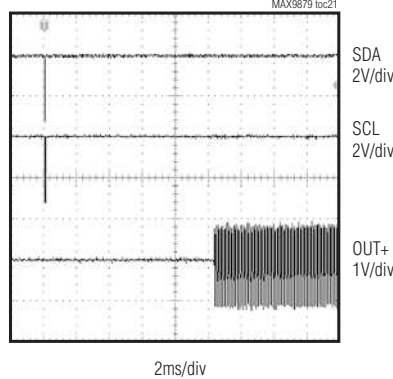
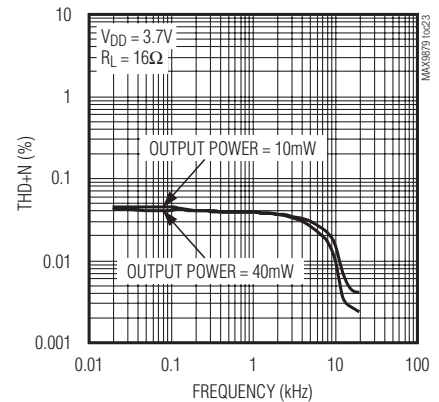

TOTAL HARMONIC DISTORTION + NOISE vs. FREQUENCY (HEADPHONE MODE)

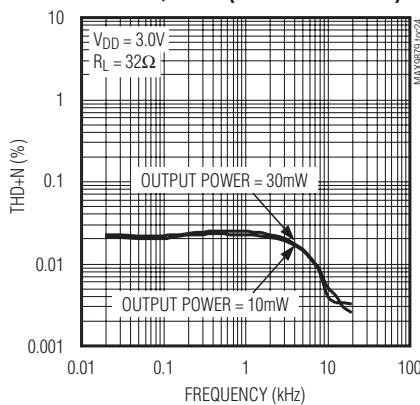

TOTAL HARMONIC DISTORTION + NOISE vs. FREQUENCY (HEADPHONE MODE)

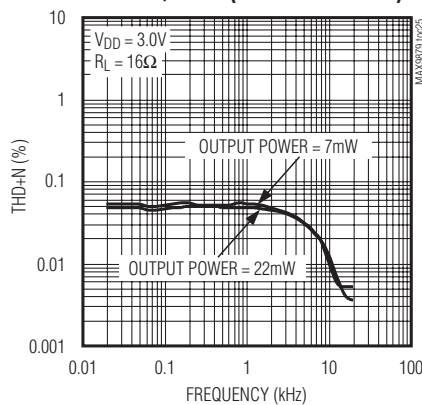

TOTAL HARMONIC DISTORTION + NOISE vs. FREQUENCY (HEADPHONE MODE)

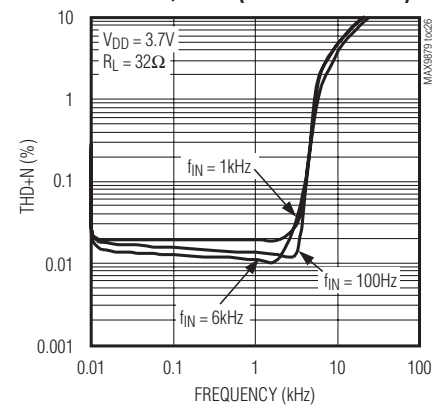

TOTAL HARMONIC DISTORTION + NOISE vs. OUTPUT POWER (HEADPHONE MODE)

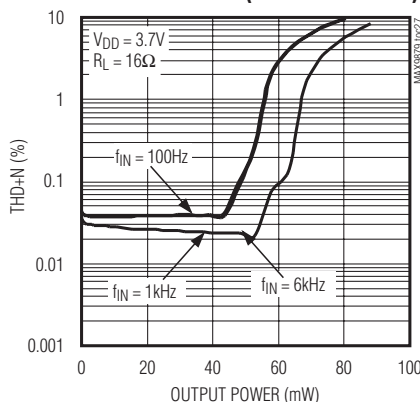

TOTAL HARMONIC DISTORTION + NOISE vs. OUTPUT POWER (HEADPHONE MODE)

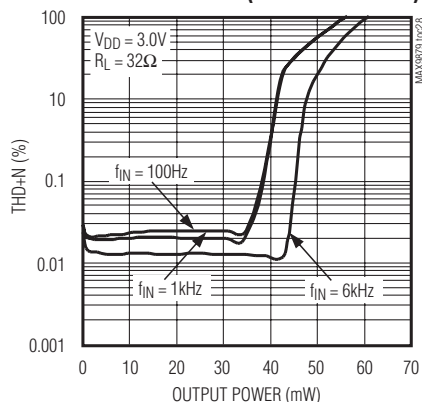

TOTAL HARMONIC DISTORTION + NOISE vs. OUTPUT POWER (HEADPHONE MODE)

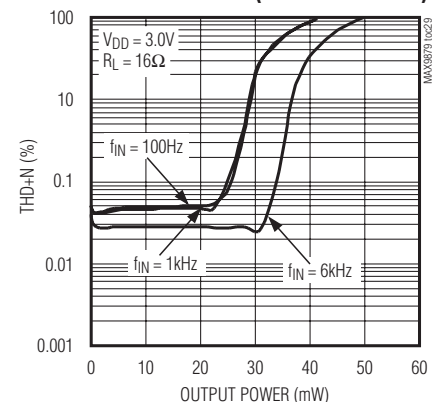

MAX9879

Stereo Class D Audio Subsystem with DirectDrive Headphone Amplifier

Typical Operating Characteristics (continued)

($V_{DD} = V_{PVDDL} = V_{PVDDR} = 3.7V$, $V_{CCIO} = 1.8V$, $V_{GND} = V_{PGNDL} = V_{PGNDR} = 0$. Single-ended inputs, preamp = 0dB, volume controls = 0dB, BYPASS = 0, SHDN = 1. Speaker loads connected between OUT_+ and OUT_-. Headphone loads connected from HPL or HPR to GND. $R_{SPK} = \infty$, $R_{HP} = \infty$. $C1 = C2 = C_{BIAS} = 1\mu F$. $T_A = +25^\circ C$, unless otherwise noted.)

HEADPHONE AMPLIFIERS (Speaker Disabled)

TOTAL HARMONIC DISTORTION + NOISE vs. OUTPUT POWER (HEADPHONE MODE)

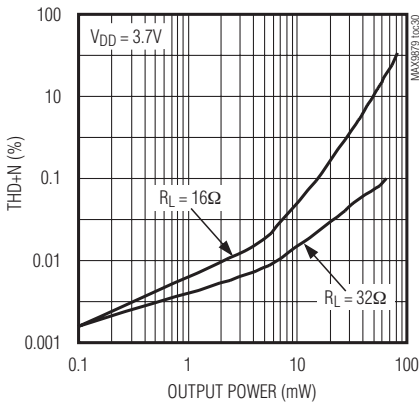

POWER DISSIPATION vs. OUTPUT POWER (HEADPHONE MODE)

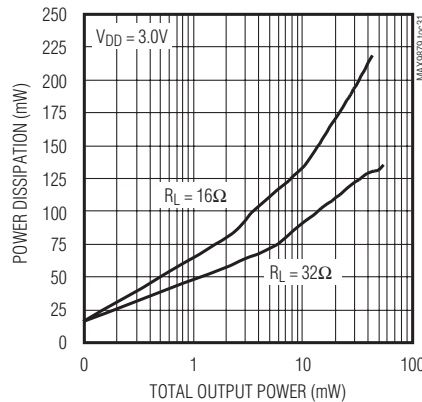

OUTPUT POWER vs. SUPPLY VOLTAGE

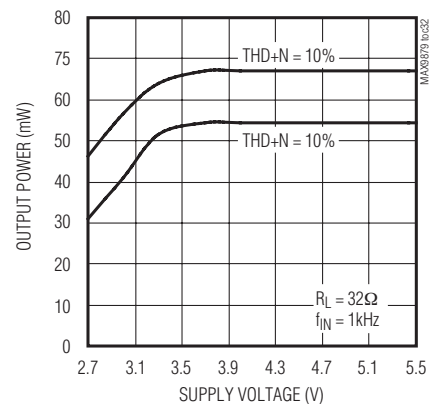

OUTPUT POWER vs. SUPPLY VOLTAGE

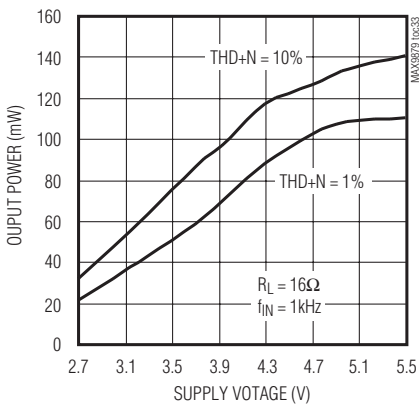

OUTPUT POWER vs. LOAD RESISTANCE (HEADPHONE MODE)

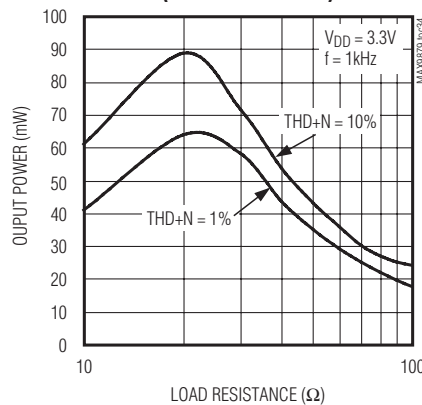

OUTPUT POWER vs. LOAD RESISTANCE (HEADPHONE MODE)

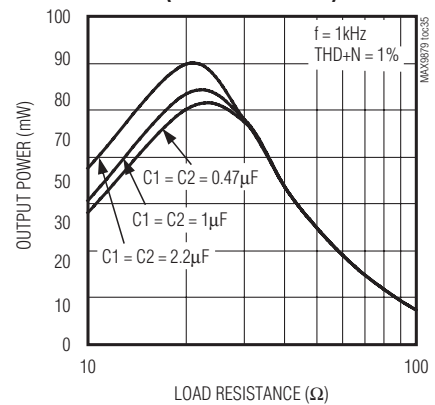

POWER SUPPLY REJECTION RATIO vs. FREQUENCY (HEADPHONE MODE)

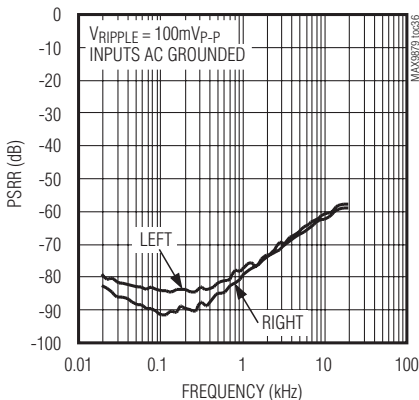

POWER SUPPLY REJECTION RATIO vs. FREQUENCY (HEADPHONE MODE)

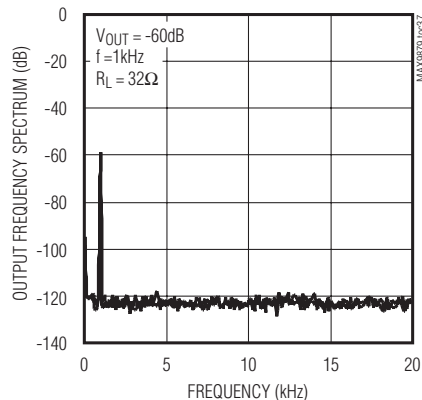

CROSSTALK vs. FREQUENCY (HEADPHONE MODE)

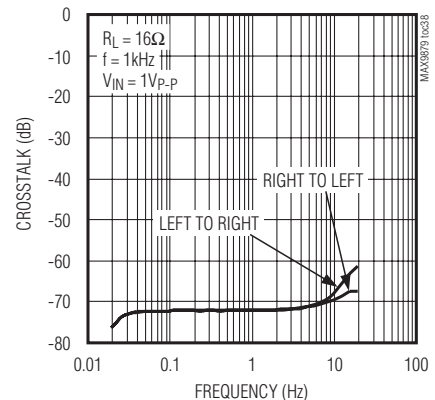

MAX9879

Stereo Class D Audio Subsystem with DirectDrive Headphone Amplifier

Typical Operating Characteristics (continued)

($V_{DD} = V_{PVDDL} = V_{PVDDR} = 3.7V$, $V_{CCIO} = 1.8V$, $V_{GND} = V_{PGNDL} = V_{PGNDR} = 0$. Single-ended inputs, preamp = 0dB, volume controls = 0dB, BYPASS = 0, SHDN = 1. Speaker loads connected between OUT_+ and OUT_-. Headphone loads connected from HPL or HPR to GND. $R_{SPK} = \infty$, $R_{HP} = \infty$. $C1 = C2 = C_{BIAS} = 1\mu F$. $T_A = +25^\circ C$, unless otherwise noted.)

HEADPHONE AMPLIFIERS (Speaker Disabled)

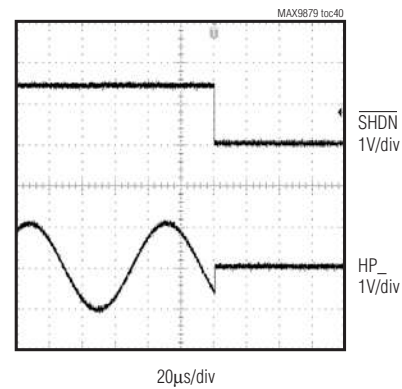
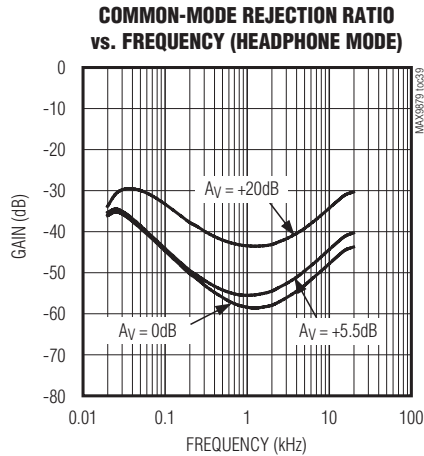

MAX9879

Stereo Class D Audio Subsystem with DirectDrive Headphone Amplifier

Typical Operating Characteristics (continued)

($V_{DD} = V_{PVDDL} = V_{PVDDR} = 3.7V$, $V_{CCIO} = 1.8V$, $V_{GND} = V_{PGNDL} = V_{PGNDR} = 0$. Single-ended inputs, preamp = 0dB, volume controls = 0dB, BYPASS = 0, SHDN = 1. Speaker loads connected between OUT_+ and OUT_-. Headphone loads connected from HPL or HPR to GND. $R_{SPK} = \infty$, $R_{HP} = \infty$. $C1 = C2 = C_{BIAS} = 1\mu F$. $T_A = +25^\circ C$, unless otherwise noted.)

ANALOG SWITCH

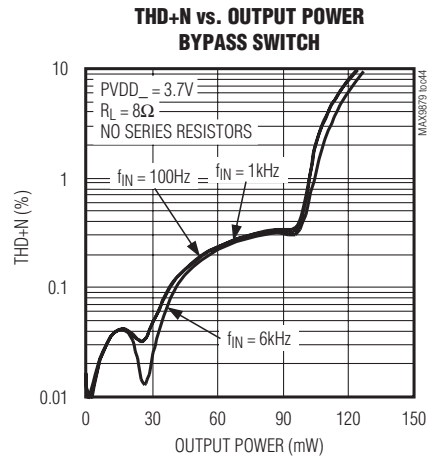
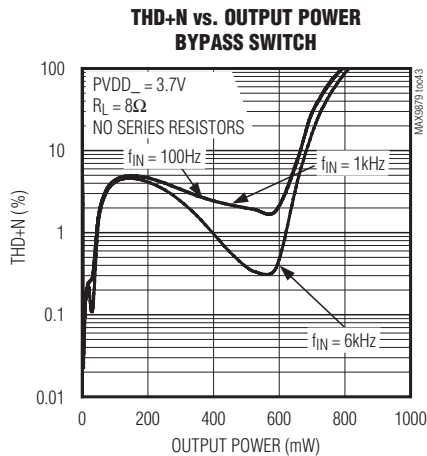
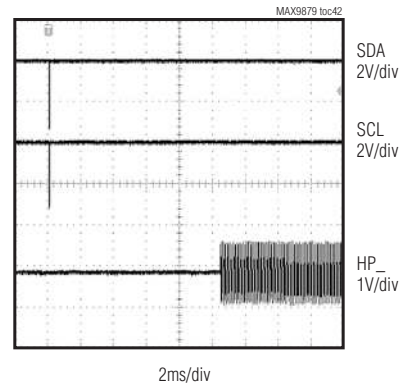
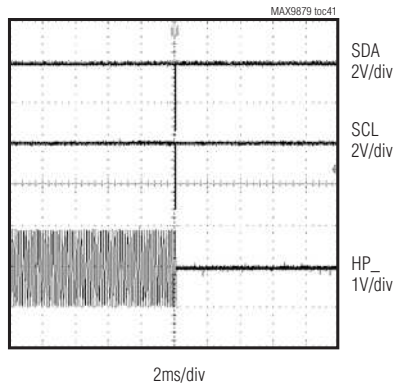

MAX9879

Stereo Class D Audio Subsystem with DirectDrive Headphone Amplifier

Pin Description

BUMP	NAME	FUNCTION
A1	C1P	Charge-Pump Flying Capacitor Positive Terminal. Connect a 1 μ F capacitor between C1P and C1N.
A2	OUTL-	Left-Speaker Negative Output
A3	PVDDL	Left-Channel Class D Power Supply. Bypass with a 1 μ F capacitor to PGNDL.
A4	OUTL+	Left-Speaker Positive Output
A5, B5	PGNDR	Right-Channel Class D Power Ground
A6	OUTR-	Right-Speaker Negative Output
B1	C1N	Charge-Pump Flying Capacitor Negative Terminal. Connect a 1 μ F capacitor between C1P and C1N.
B2	RXIN-	Receiver Bypass Negative Input
B3	PGNDL	Left-Channel Class D Power Ground
B4	RXIN+	Receiver Bypass Positive Input
B6	PVDDR	Right-Channel Class D Power Supply. Bypass with a 1 μ F capacitor to PGNDL.
C1	VSS	Headphone Amplifier Negative Power Supply. Bypass with a 1 μ F capacitor to PGND.
C2, C3, C4, C5	GND	Analog Ground
C6	OUTR+	Right-Speaker Positive Output
D1	HPL	Headphone Amplifier Right Output
D2	BIAS	Common-Mode Bias. Bypass to GND with a 1 μ F capacitor.
D3	INB1	Input B1. Left input or negative input.
D4	INA1	Input A1. Left input or negative input.
D5	SCL	Serial-Clock Input. Connect a pullup resistor from SDA to VCCIO.
D6	SDA	Serial-Data Input/Output. Connect a pullup resistor from SDA to VCCIO.
E1	HPR	Headphone Amplifier Left Output
E2	VDD	Analog Supply. Connect to PVDDL and PVDDR. Bypass with a 1 μ F capacitor to GND.
E3	INB2	Input B2. Right input or positive input.
E4	INA2	Input A2. Right input or positive input.
E5	$\overline{\text{SHDN}}$	Active-Low Shutdown Input Signal
E6	VCCIO	I ² C Power Supply

Detailed Description

Signal Path

The MAX9879 signal path consists of flexible inputs, signal mixing, volume control, and output amplifiers (Figures 1a, 1b, 1c).

The inputs can be configured for single-ended or differential signals (Figure 2). The internal preamplifiers feature three programmable gain settings of 0dB, +5.5dB, and +20dB. Following preamplification, the input signals are mixed, volume adjusted, and routed to the headphone and speaker amplifiers based on the output mode configuration (see Table 6). The volume control stages provide up to 75dB attenuation. The headphone amplifiers provide +3dB of gain while the speaker amplifier provides +18dB of additional gain.

When an input is configured as mono differential, it can be routed to both speakers or to both headphones. When an input is stereo, it is routed to either the stereo headphones or the stereo speakers. Simultaneous operation is also possible. If the right speaker amplifier is disabled then the left and right audio signals are summed into the left speaker amplifier and vice-versa.

When the application does not require the use of both INA₁ and INB₁, the SNR of the MAX9879 is improved by deselecting the unused input through the I²C output mode register and AC-coupling the unused inputs to ground with a 330pF capacitor. The 330pF capacitor and the input resistance to the MAX9879 form a high-pass filter preventing audible noise from coupling into the outputs.

MAX9879

Stereo Class D Audio Subsystem with DirectDrive Headphone Amplifier

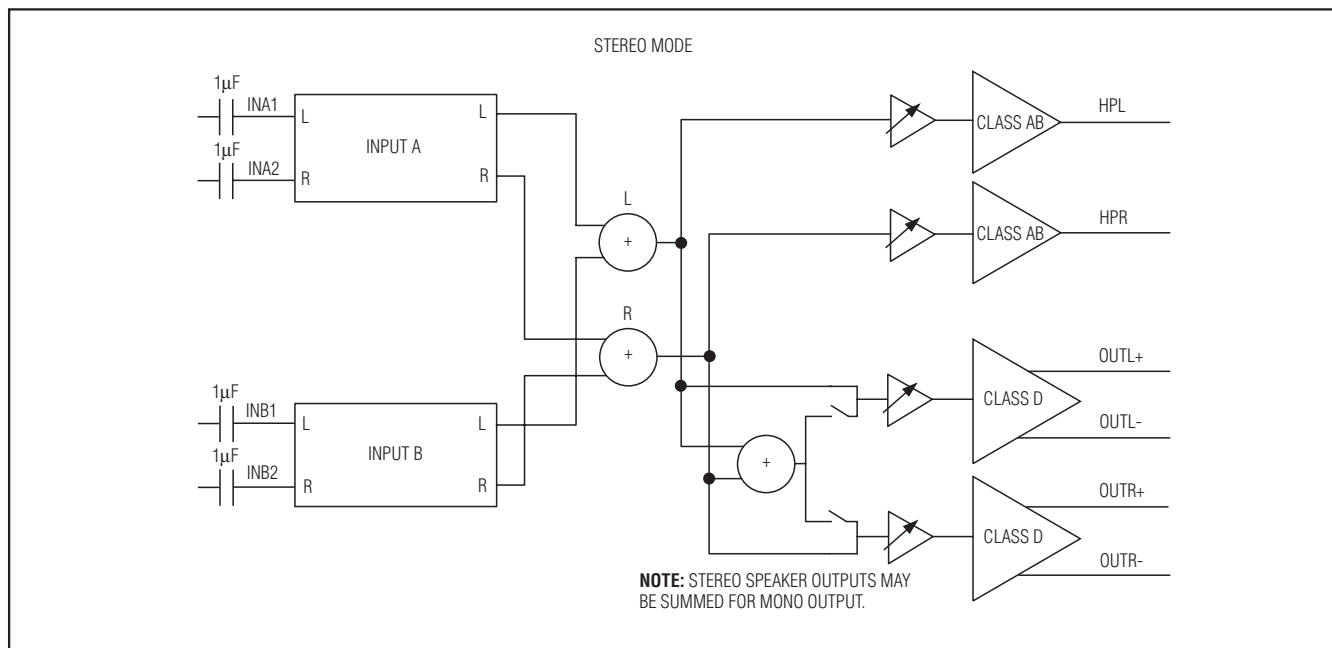

Figure 1a. Stereo-Mode Signal Path

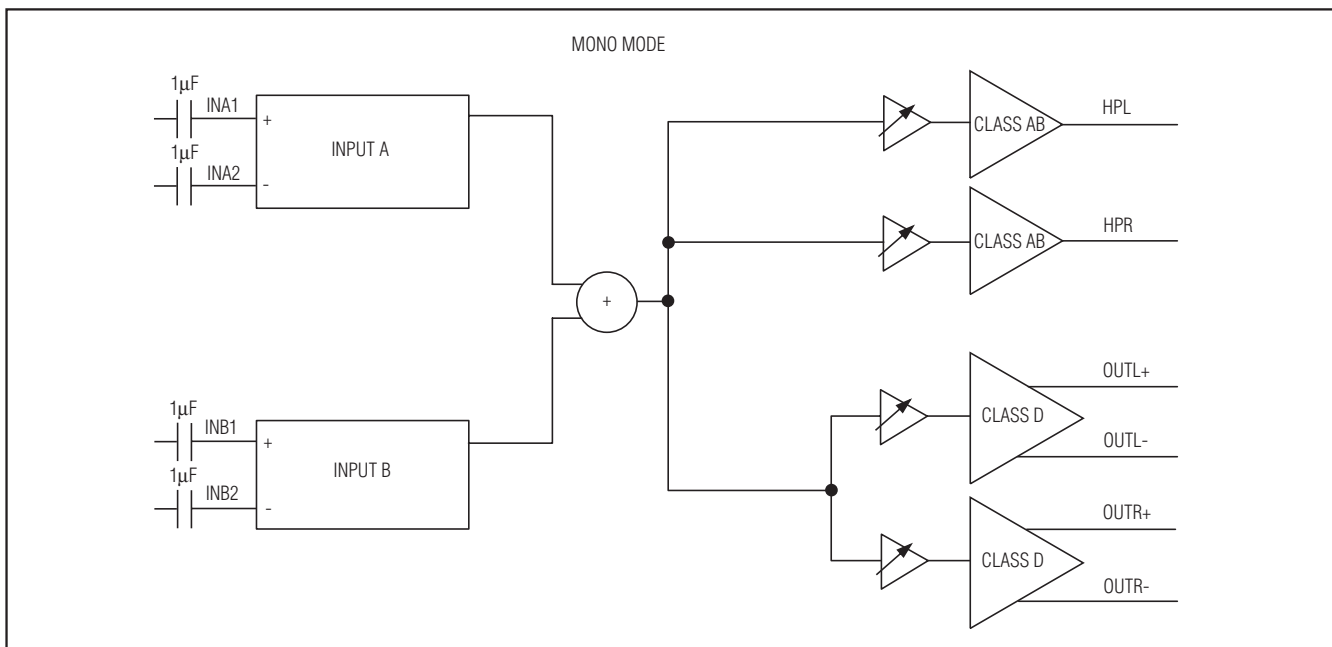

Figure 1b. Mono-Mode Signal Path

MAX9879

Stereo Class D Audio Subsystem with DirectDrive Headphone Amplifier

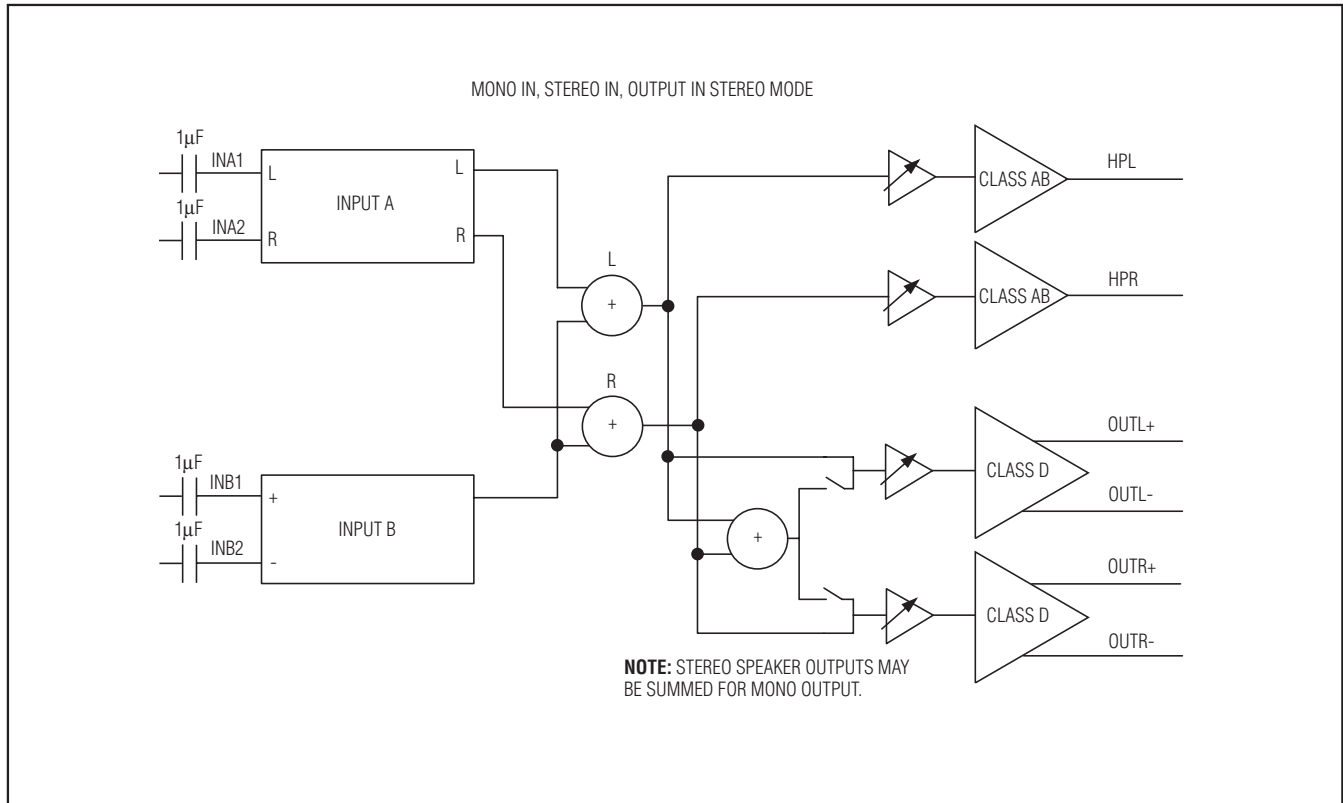

Figure 1c. Mono INB, Stereo INA, Output in Stereo-Mode Signal Path

MAX9879

Stereo Class D Audio Subsystem with DirectDrive Headphone Amplifier

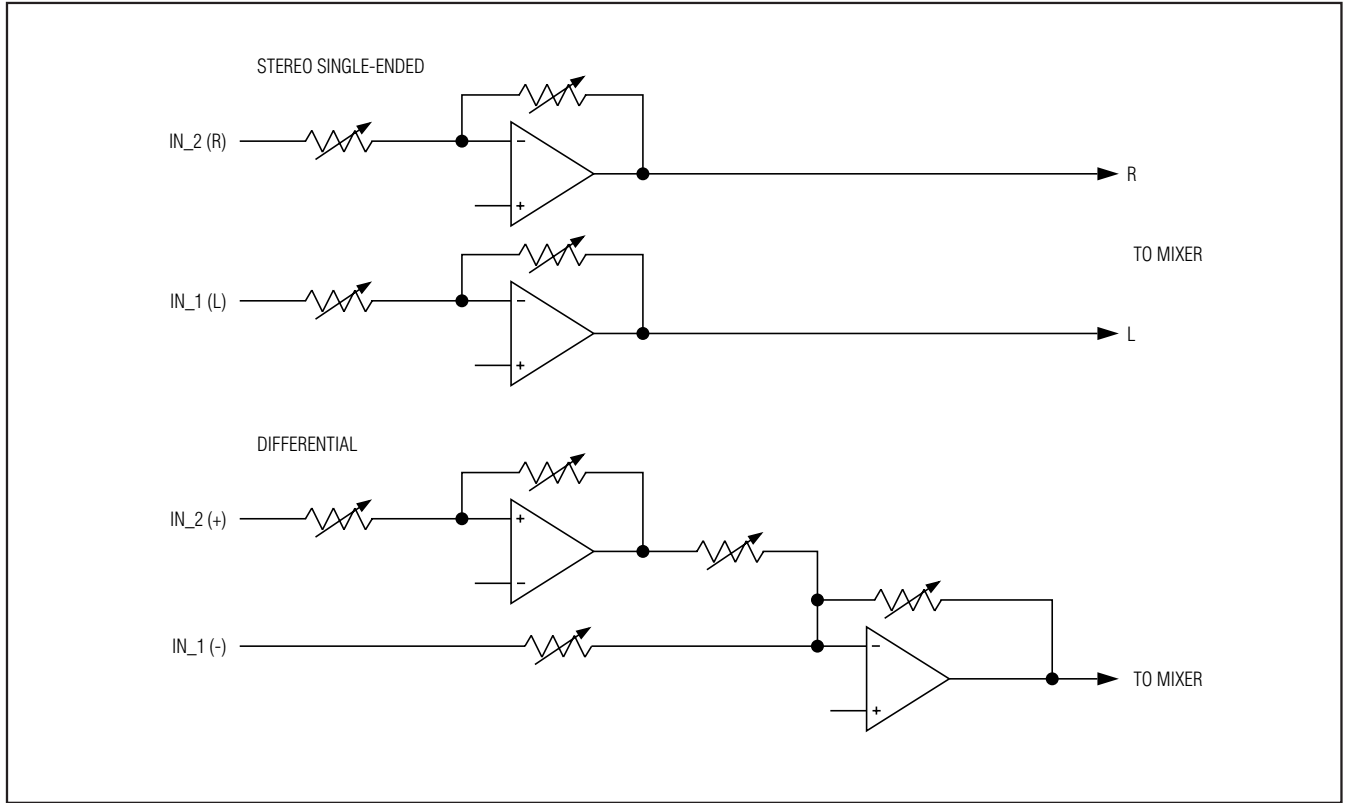

Figure 2. Differential and Stereo Single-Ended Input Configurations

MAX9879

Stereo Class D Audio Subsystem with DirectDrive Headphone Amplifier

Volume Control and Mute

The MAX9879 features three Volume Control registers (see Table 4), allowing independent volume control of speaker and headphone amplifier outputs. There is one Speaker Volume Control register that evenly controls both speaker outputs. Two Headphone Volume Control registers provide independent control of each headphone output. Each volume control register provides 31 attenuation steps providing 0dB to -75dB (typ) of total attenuation and a mute function.

Class D Speaker Amplifier

The MAX9879 integrates a filterless Class D amplifier that offers much higher efficiency than Class AB without the typical disadvantages.

The high efficiency of a Class D amplifier is due to the switching operation of the output stage transistors. In a Class D amplifier, the output transistors act as current-steering switches and consume negligible additional power. Any power loss associated with the Class D output stage is mostly due to the I^2R loss of the MOSFET on-resistance, and quiescent current overhead.

The theoretical best efficiency of a linear amplifier is 78%, however, that efficiency is only exhibited at peak output power. Under normal operating levels (typical music reproduction levels), efficiency falls below 30%, whereas the MAX9879 still exhibits 88% efficiency under the same conditions (Figure 3).

Ultra-Low EMI Filterless Output Stage

In traditional Class D amplifiers, the high dV/dt of the rising and falling edge transitions results in increased EMI emissions, which requires the use of external LC filters or shielding to meet EN55022 electromagnetic-

interference (EMI) regulation standards. Limiting the dV/dt normally results in decreased efficiency. Maxim's active emissions limiting circuitry actively limits the dV/dt of the rising and falling edge transitions, providing reduced EMI emissions, while maintaining up to 88% efficiency.

In addition to active emission limiting, the MAX9879 features a spread-spectrum modulation mode that flattens the wideband spectral components. Proprietary techniques ensure that the cycle-to-cycle variation of the switching period does not degrade audio reproduction or efficiency (see the *Typical Operating Characteristics*). With spread-spectrum modulation, the switching frequency varies randomly by $\pm 40\text{kHz}$ around the center frequency (700kHz). The effect is to reduce the peak energy at harmonics of the switching frequency. Above 10MHz, the wideband spectrum looks like white noise for EMI purposes (see Figure 4).

Speaker Current Limit

Most applications do not enter current limit unless the output is short circuited or connected incorrectly.

When the output current of the speaker amplifier exceeds the current limit (1.5A, typ) the MAX9879 disables the outputs for approximately 250 μs . At the end of 250 μs , the outputs are re-enabled, and if the fault condition still exists, the MAX9879 continues to disable and re-enable the outputs until the fault condition is removed.

Bypass Mode

The integrated DPST analog audio switch allows the MAX9879's Class D amplifier to be bypassed. In bypass mode, the Class D amplifier is automatically disabled allowing an external amplifier to drive the speaker connected between OUTL+ and OUTL- through RXIN+ and RXIN- (see the *Typical Application Circuit*).

The bypass switch is enabled at startup. The switch can be opened or closed even when the MAX9879 is in software shutdown (see the *I²C Register Description* section).

Unlike discrete solutions, the switch design reduces coupling of Class D switching noise to the RXIN_ inputs. This eliminates the need for a costly T-switch.

The bypass switch is typically used with two 10 Ω resistors connected to each input. These resistors, in combination with the switch on-resistance and an 8 Ω load, approximate the 32 Ω load expected by the external amplifier. Although not required, using the resistors optimizes THD+N.

Drive RXIN+ and RXIN- with a low-impedance source to minimize noise on the pins. In applications that do not require the bypass mode, leave RXIN+ and RXIN- unconnected.

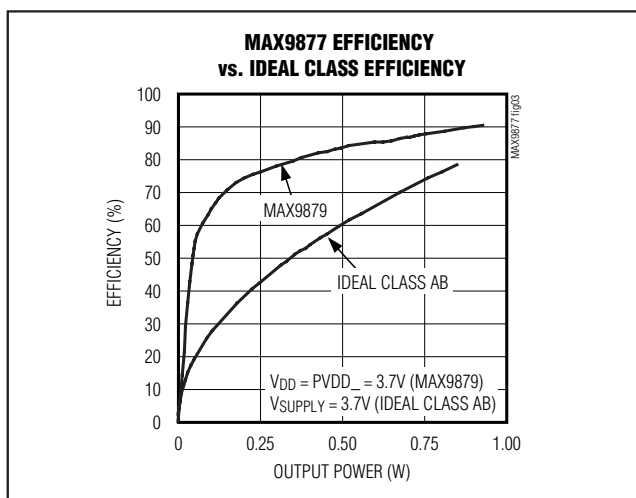

Figure 3. MAX9879 Efficiency vs. Class AB Efficiency

MAX9879

Stereo Class D Audio Subsystem with DirectDrive Headphone Amplifier

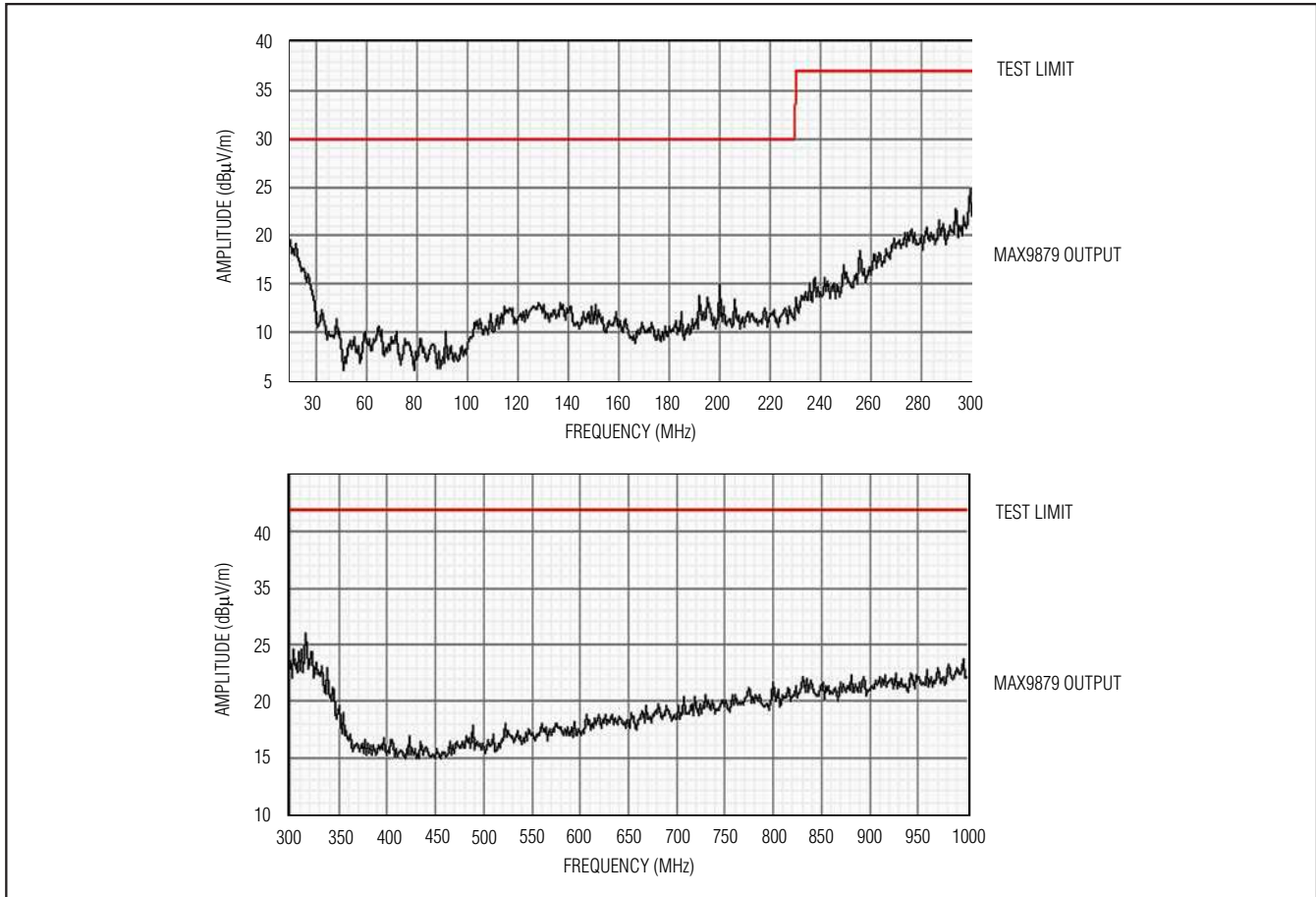

Figure 4. EMI with 152mm of Speaker Cable

DirectDrive Headphone Amplifier

Traditional single-supply headphone amplifiers have outputs biased at a nominal DC voltage (typically half the supply). Large coupling capacitors are needed to block this DC bias from the headphone. Without these capacitors, a significant amount of DC current flows to the headphone, resulting in unnecessary power dissipation and possible damage to both the headphone and headphone amplifier.

Maxim's DirectDrive® architecture uses a charge pump to create an internal negative supply voltage. This allows the headphone outputs of the MAX9879 to be biased at GND while operating from a single supply (Figure 5). Without a DC component, there is no need for the large DC-blocking capacitors. Instead of two large (220µF, typ) capacitors, the MAX9879 charge pump requires two small ceramic capacitors, conserv-

ing board space, reducing cost, and improving the frequency response of the headphone amplifier. See the Output Power vs. Load Resistance graph in the *Typical Operating Characteristics* for details of the possible capacitor sizes. There is a low DC voltage on the amplifier outputs due to amplifier offset. However, the offset of the MAX9879 is typically $\pm 1.5\text{mV}$, which, when combined with a 32Ω load, results in less than $47\mu\text{A}$ of DC current flow to the headphones.

In addition to the cost and size disadvantages of the DC-blocking capacitors required by conventional headphone amplifiers, these capacitors limit the amplifier's low-frequency response and can distort the audio signal. Previous attempts at eliminating the output-coupling capacitors involved biasing the headphone return (sleeve) to the DC bias voltage of the headphone amplifiers. This method raises some issues:

DirectDrive is a registered trademark of Maxim Integrated Products, Inc.

Stereo Class D Audio Subsystem with DirectDrive Headphone Amplifier

- 1) The sleeve is typically grounded to the chassis. Using the midrail biasing approach, the sleeve must be isolated from system ground, complicating product design.
- 2) During an ESD strike, the amplifier's ESD structures are the only path to system ground. Thus, the amplifier must be able to withstand the full energy from an ESD strike.
- 3) When using the headphone jack as a line out to other equipment, the bias voltage on the sleeve may conflict with the ground potential from other equipment, resulting in possible damage to the amplifiers.

The MAX9879 features a low-noise charge pump. The switching frequency of the charge pump is $1/2$ of the Class D switching frequency, regardless of the operating mode. Since the Class D amplifiers are operated in spread-spectrum mode, the charge pump also switches with a spread-spectrum pattern. The nominal switching frequency is well beyond the audio range, and thus does not interfere with audio signals. The switch drivers feature a controlled switching speed that minimizes noise generated by turn-on and turn-off transients. By limiting the switching speed of the charge pump, the di/dt noise

caused by the parasitic trace inductance is minimized. Although not typically required, additional high-frequency noise attenuation can be achieved by increasing the size of C2 (see the *Typical Application Circuit*). The charge pump is active only in headphone modes.

Headphone Current Limit

The headphone amplifier current is limited to 140mA (typ). The current limit clamps the output current, which appears as clipping when the maximum current is exceeded.

Shutdown Mode

The MAX9879 features two ways of entering low-power shutdown:

- The device can be placed in shutdown mode by writing to the $\overline{\text{SHDN}}$ bit in the Output Control Register.
- The device can be placed in an ultra-low power shutdown mode by setting the $\overline{\text{SHDN}}$ pin to 0V. This completely disables the MAX9879 including the I²C interface.

Click-and-Pop Suppression

The MAX9879 features click-and-pop suppression that eliminates audible transients from occurring at startup and shutdown.

Use the following procedure to start up the MAX9879:

- 1) Configure the desired output mode and preamplifier gain.
- 2) Set the $\overline{\text{SHDN}}$ bit to 1 to start up the amplifier.
- 3) Wait 10ms for the startup time to pass.
- 4) Increase the output volume to the desired level.

To disable the device simply set $\overline{\text{SHDN}}$ to 0.

During the startup period, the MAX9879 precharges the input capacitors to prevent clicks and pops. If the output amplifiers have been programmed to be active they are held in shutdown until the precharge period is complete.

When power is initially applied to the MAX9879, the power-on-reset state of all three volume control registers is mute. For most applications, the volume can be set to the desired level once the device is active. If the click-and-pop is too high, step through intermediate volume settings with zero-crossing detection disabled. Stepping through higher volume settings has a greater impact on click-and-pop than lower volume settings.

For the lowest possible click and pop, start up the device at minimum volume and then step through each volume setting until the desired setting is reached. Disable zero-crossing detection if no input signal is expected.

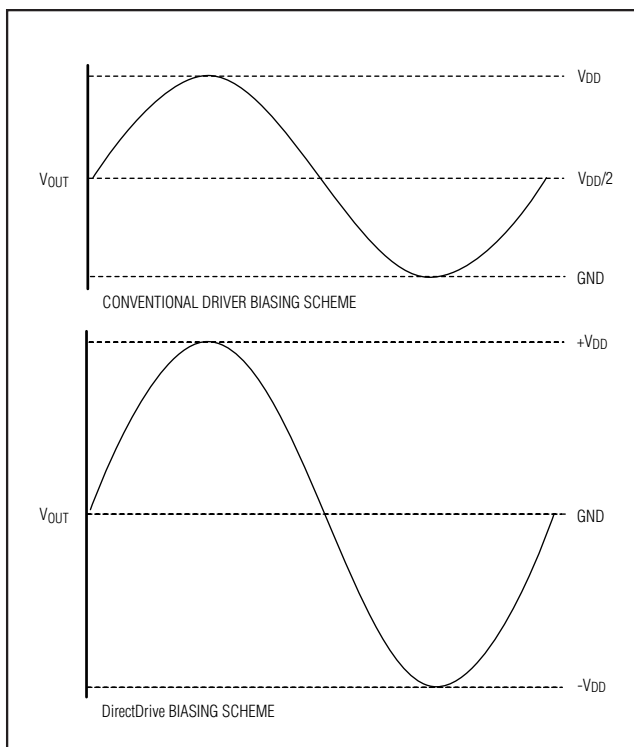

Figure 5. Traditional Amplifier Output vs. MAX9879 DirectDrive Output

MAX9879

Stereo Class D Audio Subsystem with DirectDrive Headphone Amplifier

I²C Interface

I²C Address

The slave address of the MAX9879 is 1001101R/(W)
(write: 0x9A, read: 0x9B).

Table 1. Register Map

REGISTER	REGISTER ADDRESS	POR STATE	B7	B6	B5	B4	B3	B2	B1	B0
Input Mode Control	0x00	0x40	0	ZCD	Δ INA	Δ INB	PGAINA		PGAINB	
Speaker Volume Control	0x01	0x00	0	0	0	SPKVOL				
Left Headphone Volume Control	0x02	0x00	0	0	0	HPLVOL				
Right Headphone Volume Control	0x03	0x00	0	0	0	HPRVOL				
Output Mode Control	0x04	0x49	$\overline{\text{SHDN}}$	BYPASS	0	ENB	ENA	LSPK EN	RSPK EN	HPEN

Table 2. Input Mode Control Register

REGISTER	B7	B6	B5	B4	B3	B2	B1	B0	
0x00	0	ZCD	Δ INA	Δ INB	PGAINA		PGAINB		

I²C Register Description

Zero-Crossing Detection (ZCD)

Zero-crossing detection limits distortion in the output signal during volume transitions by delaying the transition until the mixer output crosses the internal bias voltage. A timeout period (typically 60ms) forces the volume transition if the mixer output signal does not cross the bias voltage.

1 = Zero-crossing detection is enabled.

0 = Zero-crossing detection is disabled.

Differential Input Configuration (Δ IN_{_)}

The inputs INA_{_) and INB_{_) can be configured for mono differential or stereo single-ended operation.}}

1 = IN_{_) is configured as a mono differential input with IN_{2) as the positive and IN_{1) as the negative input.}}}

0 = IN_{_) is configured as a stereo single-ended input with IN_{2) as the right and IN_{1) as the left input.}}}

Preamplifier Gain (PGAIN_{_)}

The preamplifier gain of INA_{_) and INB_{_) can be programmed by writing to PGAIN_{_) .}}}

00 = 0dB

01 = +5.5dB

10 = +20dB

11 = Reserved

Stereo Class D Audio Subsystem with DirectDrive Headphone Amplifier

Table 3. Speaker/Left Headphone/Right Headphone Volume Control

REGISTER	B7	B6	B5	B4	B3	B2	B1	B0
0x01	0	0	0	SVOL (Table 4)				
0x02	0	0	0	HPLVOL (Table 4)				
0x03	0	0	0	HPRVOL (Table 4)				

Volume Control

The device has a separate volume control for left headphone, right headphone, and speaker amplifiers. The

total system gain is a combination of the input gain, the volume control, and the output amplifier gain. Table 4 shows the volume settings for each volume control.

Table 4. Volume Control Settings

CODE	_VOL					GAIN (dB)
	B4	B3	B2	B1	B0	
0	0	0	0	0	0	MUTE
1	0	0	0	0	1	-75
2	0	0	0	1	0	-71
3	0	0	0	1	1	-67
4	0	0	1	0	0	-63
5	0	0	1	0	1	-59
6	0	0	1	1	0	-55
7	0	0	1	1	1	-51
8	0	1	0	0	0	-47
9	0	1	0	0	1	-44
10	0	1	0	1	0	-41
11	0	1	0	1	1	-38
12	0	1	1	0	0	-35
13	0	1	1	0	1	-32
14	0	1	1	1	0	-29
15	0	1	1	1	1	-26

CODE	_VOL					GAIN (dB)
	B4	B3	B2	B1	B0	
16	1	0	0	0	0	-23
17	1	0	0	0	1	-21
18	1	0	0	1	0	-19
19	1	0	0	1	1	-17
20	1	0	1	0	0	-15
21	1	0	1	0	1	-13
22	1	0	1	1	0	-11
23	1	0	1	1	1	-9
24	1	1	0	0	0	-7
25	1	1	0	0	1	-6
26	1	1	0	1	0	-5
27	1	1	0	1	1	-4
28	1	1	1	0	0	-3
29	1	1	1	0	1	-2
30	1	1	1	1	0	-1
31	1	1	1	1	1	0

Table 5. Output Mode Control

REGISTER	B7	B6	B5	B4	B3	B2	B1	B0
0x04	$\overline{\text{SHDN}}$	BYPASS	0	ENB	ENA	LSPK EN	RSPK EN	HPEN

Shutdown ($\overline{\text{SHDN}}$)

1 = MAX9879 operational.

0 = MAX9879 in low-power shutdown mode.

$\overline{\text{SHDN}}$ is an active-low shutdown bit that overrides all settings and places the entire device in low-power shutdown mode. The I²C interface is fully active in this shutdown mode and bypass mode remains operational.

MAX9879

Stereo Class D Audio Subsystem with DirectDrive Headphone Amplifier

Bypass Mode (BYPASS)

1 = MAX9879 bypass switches are closed and the Class D amplifier is disabled.

0 = Bypass mode disabled.

This mode does not control headphone operation.

Output Mode Control Register

Speaker/Headphone Output Mode (_SPKEN/HPEN)

The MAX9879 features independent enables and input selection for each speaker amplifier and the headphone amplifier. See Table 6 for a detailed description of the available modes. If the right speaker amplifier is disabled, the stereo signals are automatically summed to mono for the left output and vice-versa.

Table 6. Speaker/Headphone Modes

BIT	DESCRIPTION
LSPKEN	Enable bit for left speaker
RSPKEN	Enable bit for right speaker
HPEN	Enable bit for headphone amplifier
ENA	Enable bit for input A
ENB	Enable bit for input B

I²C Interface Specification

The MAX9879 features an I²C/SMBus™-compatible, 2-wire serial interface consisting of a serial-data line (SDA) and a serial-clock line (SCL). SDA and SCL facilitate communication between the MAX9879 and the master at clock rates up to 400kHz. Figure 6 shows the 2-wire interface timing diagram. The master generates SCL and initiates data transfer on the bus. The master device writes data to the MAX9879 by transmitting the

proper slave address followed by the register address and then the data word. Each transmit sequence is framed by a START (S) or REPEATED START (Sr) condition and a STOP (P) condition. Each word transmitted to the MAX9879 is 8 bits long and is followed by an acknowledge clock pulse. A master reading data from the MAX9879 transmits the proper slave address followed by a series of nine SCL pulses. The MAX9879 transmits data on SDA in sync with the master-generated SCL pulses. The master acknowledges receipt of each byte of data. Each read sequence is framed by a START (S) or REPEATED START (Sr) condition, a not acknowledge, and a STOP (P) condition. SDA operates as both an input and an open-drain output. A pullup resistor, typically greater than 500Ω, is required on SDA. SCL operates only as an input. A pullup resistor, typically greater than 500Ω, is required on SCL if there are multiple masters on the bus, or if the single master has an open-drain SCL output. Series resistors in line with SDA and SCL are optional. Series resistors protect the digital inputs of the MAX9879 from high voltage spikes on the bus lines, and minimize crosstalk and undershoot of the bus signals.

Bit Transfer

One data bit is transferred during each SCL cycle. The data on SDA must remain stable during the high period of the SCL pulse. Changes in SDA while SCL is high are control signals (see the *START and STOP Conditions* section).

START and STOP Conditions

SDA and SCL idle high when the bus is not in use. A master initiates communication by issuing a START condition. A START (S) condition is a high-to-low transition on SDA with SCL high. A STOP (P) condition is a low-to-high transition on SDA while SCL is high (Figure 7).

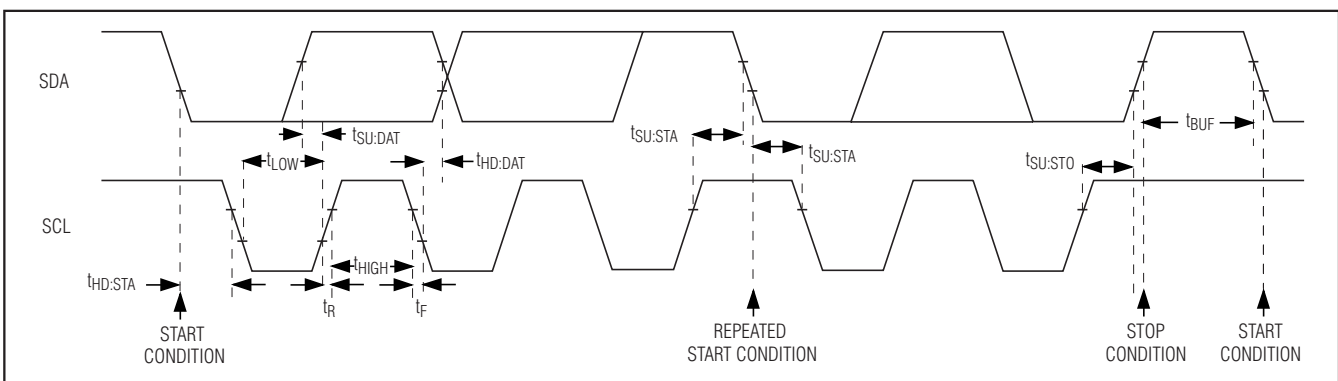

Figure 6. 2-Wire Interface Timing Diagram

SMBus is a trademark of Intel Corp.

MAX9879

Stereo Class D Audio Subsystem with DirectDrive Headphone Amplifier

A START (S) condition from the master signals the beginning of a transmission to the MAX9879. The master terminates transmission, and frees the bus, by issuing a STOP condition. The bus remains active if a REPEATED START (Sr) condition is generated instead of a STOP condition.

Early STOP Conditions

The MAX9879 recognizes a STOP (P) condition at any point during data transmission except if the STOP (P) condition occurs in the same high pulse as a START (S) condition. For proper operation, do not send a STOP (P) condition during the same SCL high pulse as the START (S) condition.

Slave Address

The MAX9879 is preprogrammed with a slave address of 1001101R/(W). The address is defined as the seven most significant bits (MSBs) followed by the Read/Write bit. Setting the Read/Write bit to 1 configures the MAX9879 for read mode. Setting the Read/Write bit to 0 configures the MAX9879 for write mode. The address is the first byte of information sent to the MAX9879 after the START (S) condition.

Acknowledge

The acknowledge bit (ACK) is a clocked 9th bit that the MAX9879 uses to handshake receipt of each byte of data when in write mode (see Figure 8). The MAX9879 pulls down SDA during the entire master-generated 9th clock pulse if the previous byte is successfully received. Monitoring ACK allows for detection of unsuccessful data transfers. An unsuccessful data transfer occurs if a receiving device is busy or if a system fault has occurred. In the event of an unsuccessful data transfer, the bus master may retry communication.

The master pulls down SDA during the ninth clock cycle to acknowledge receipt of data when the MAX9879 is in read mode. An acknowledge is sent by the master after each read byte to allow data transfer to continue. A not acknowledge is sent when the master reads the final byte of data from the MAX9879, followed by a STOP (P) condition.

Write Data Format

A write to the MAX9879 includes transmission of a START (S) condition, the slave address with the R/W bit set to 0, one byte of data to configure the internal register address pointer, one or more bytes of data, and a STOP (P) condition. Figure 9 illustrates the proper frame format for writing one byte of data to the

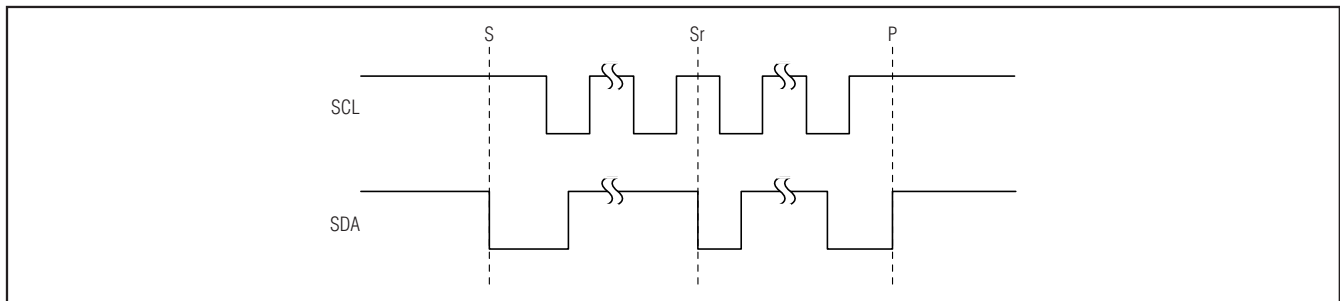

Figure 7. START (S), STOP (P), and REPEATED START (Sr) Conditions

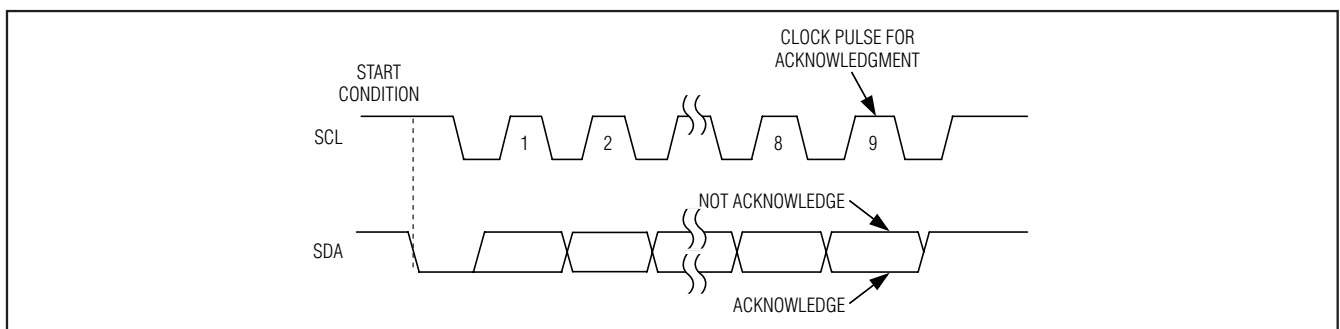

Figure 8. Acknowledge

MAX9879

Stereo Class D Audio Subsystem with DirectDrive Headphone Amplifier

MAX9879. Figure 10 illustrates the frame format for writing n bytes of data to the MAX9879.

The slave address with the R/\bar{W} bit set to 0 indicates that the master intends to write data to the MAX9879. The MAX9879 acknowledges receipt of the address byte during the master-generated 9th SCL pulse.

The second byte transmitted from the master configures the MAX9879's internal register address pointer. The pointer tells the MAX9879 where to write the next byte of data. An acknowledge pulse is sent by the MAX9879 upon receipt of the address pointer data.

The third byte sent to the MAX9879 contains the data that is written to the chosen register. An acknowledge pulse from the MAX9879 signals receipt of the data byte. The address pointer autoincrements to the next register address after each received data byte. This autoincrement feature allows a master to write to sequential registers within one continuous frame. Figure 10 illustrates how to write to multiple registers with one frame. The master signals the end of transmission by issuing a STOP (P) condition.

Register addresses greater than 0x04 are reserved. Do not write to these addresses.

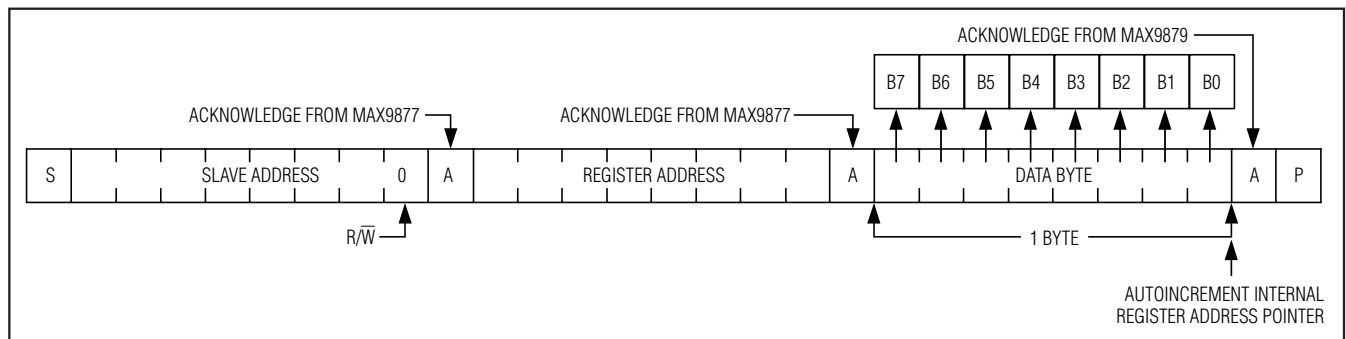

Figure 9. Writing One Byte of Data to the MAX9879

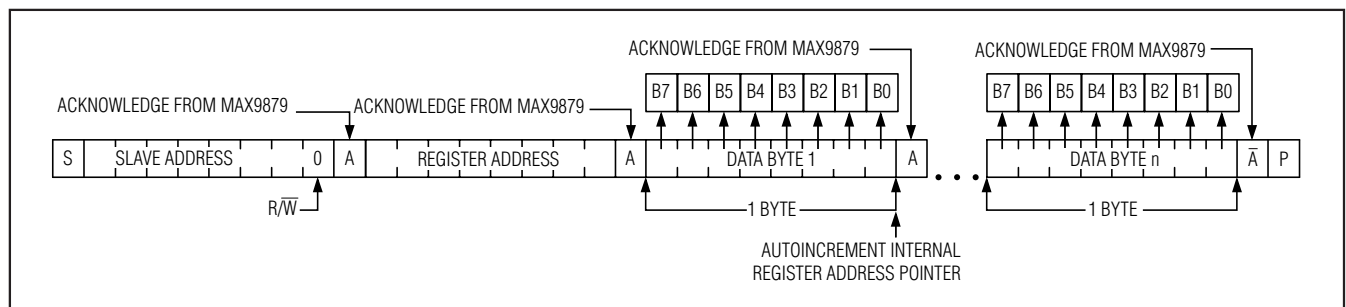

Figure 10. Writing n Bytes of Data to the MAX9879

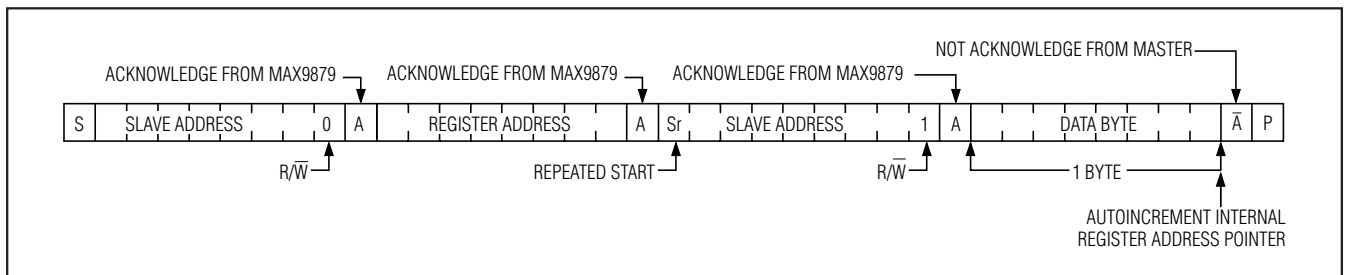

Figure 11. Reading One Indexed Byte of Data from the MAX9879

MAX9879

Stereo Class D Audio Subsystem with DirectDrive Headphone Amplifier

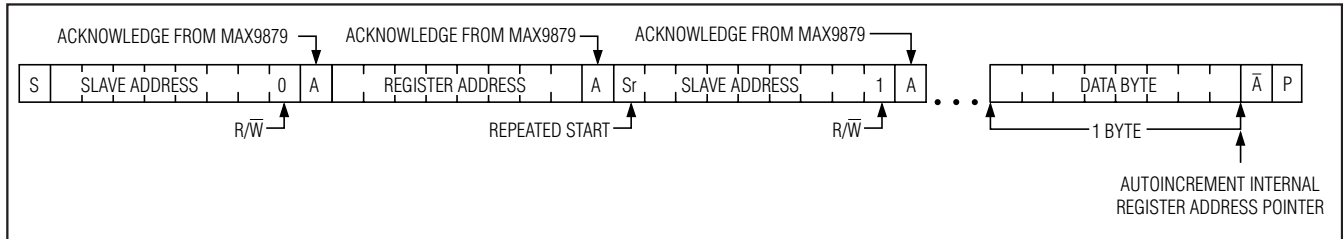

Figure 12. Reading n Bytes of Indexed Data from the MAX9879

Read Data Format

Send the slave address with the R/\bar{W} bit set to 1 to initiate a read operation. The MAX9879 acknowledges receipt of its slave address by pulling SDA low during the 9th SCL clock pulse. A START (S) command followed by a read command resets the address pointer to register 0x00. The first byte transmitted from the MAX9879 is the contents of register 0x00. Transmitted data is valid on the rising edge of SCL. The address pointer autoincrements after each read data byte. This autoincrement feature allows all registers to be read sequentially within one continuous frame. A STOP (P) condition can be issued after any number of read data bytes. If a STOP (P) condition is issued followed by another read operation, the first data byte to be read will be from register 0x00.

The address pointer can be preset to a specific register before a read command is issued. The master presets the address pointer by first sending the MAX9879's slave address with the R/\bar{W} bit set to 0 followed by the register address. A REPEATED START (S_r) condition is then sent followed by the slave address with the R/\bar{W} bit set to 1. The MAX9879 then transmits the contents of the specified register. The address pointer autoincrements after transmitting the first byte. The master acknowledges receipt of each read byte during the acknowledge clock pulse. The master must acknowledge all correctly received bytes except the last byte. The final byte must be followed by a not acknowledge from the master and then a STOP (P) condition. Figure 11 illustrates the frame format for reading one byte from the MAX9879. Figure 12 illustrates the frame format for reading multiple bytes from the MAX9879.

Applications Information

Filterless Class D Operation

Traditional Class D amplifiers require an output filter to recover the audio signal from the amplifier's output. The

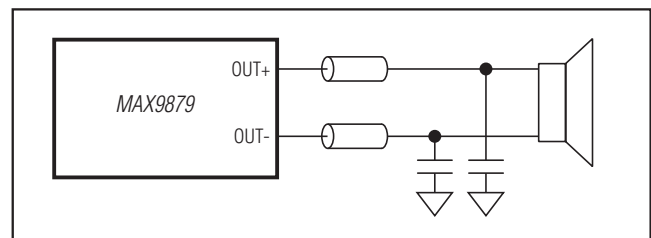

Figure 13. Optional Ferrite Bead Filter

filters add cost, increase the solution size of the amplifier, and can decrease efficiency and THD+N performance. The traditional PWM scheme uses large differential output swings ($2 \times V_{DD(P-P)}$) and causes large ripple currents. Any parasitic resistance in the filter components results in a loss of power, lowering the efficiency.

The MAX9879 does not require an output filter. The device relies on the inherent inductance of the speaker coil and the natural filtering of both the speaker and the human ear to recover the audio component of the square-wave output. Eliminating the output filter results in a smaller, less costly, more efficient solution.

Because the frequency of the MAX9879 output is well beyond the bandwidth of most speakers, voice coil movement due to the square-wave frequency is very small. Although this movement is small, a speaker not designed to handle the additional power can be damaged. For optimum results, use a speaker with a series inductance $> 10\mu\text{H}$. Typical 8Ω speakers exhibit series inductances in the $20\mu\text{H}$ to $100\mu\text{H}$ range.

Component Selection

Optional Ferrite Bead Filter

In applications where speaker leads exceed 20mm, additional EMI suppression can be achieved by using a filter constructed from a ferrite bead and a capacitor to ground. A ferrite bead with low DC resistance, high-frequency ($> 1.176\text{MHz}$) impedance of 100Ω to 600Ω , and rated for at least 1A should be used. The capacitor value varies based on the ferrite bead chosen and the

MAX9879

Stereo Class D Audio Subsystem with DirectDrive Headphone Amplifier

actual speaker lead length. Select a capacitor less than 1nF based on EMI performance.

Input Capacitor

An input capacitor, C_{IN} , in conjunction with the input impedance of the MAX9879 forms a highpass filter that removes the DC bias from an incoming signal. The AC-coupling capacitor allows the amplifier to automatically bias the signal to an optimum DC level. Assuming zero source impedance, the -3dB point of the highpass filter is given by:

$$f_{-3dB} = \frac{1}{2\pi R_{IN} C_{IN}}$$

Choose C_{IN} so that f_{-3dB} is well below the lowest frequency of interest. Use capacitors whose dielectrics have low-voltage coefficients, such as tantalum or aluminum electrolytic. Capacitors with high-voltage coefficients, such as ceramics, may result in increased distortion at low frequencies.

BIAS Capacitor

BIAS is the output of the internally generated DC bias voltage. The BIAS bypass capacitor, C_{BIAS} , reduces power supply and other noise sources at the common-mode bias node. Bypass BIAS with a 1 μ F capacitor to GND.

Charge-Pump Capacitor Selection

Use capacitors with an ESR less than 100m Ω for optimum performance. Low-ESR ceramic capacitors minimize the output resistance of the charge pump. Most surface-mount ceramic capacitors satisfy the ESR requirement. For best performance over the extended temperature range, select capacitors with an X7R dielectric.

Flying Capacitor (C1)

The value of the flying capacitor (C1) affects the output resistance of the charge pump. A C1 value that is too small degrades the device's ability to provide sufficient current drive, which leads to a loss of output voltage. Increasing the value of C1 reduces the charge-pump output resistance to an extent. Above 1 μ F, the on-resistance of the switches and the ESR of C1 and C2 dominate.

Output Holding Capacitor (C2)

The output capacitor value and ESR directly affect the ripple at V_{SS} . Increasing the value of C2 reduces output ripple. Likewise, decreasing the ESR of C2 reduces both ripple and output resistance. Lower capacitance values can be used in systems with low maximum output power levels. See the *Output Power vs. Load Resistance* graph in the *Typical Operating Characteristics*.

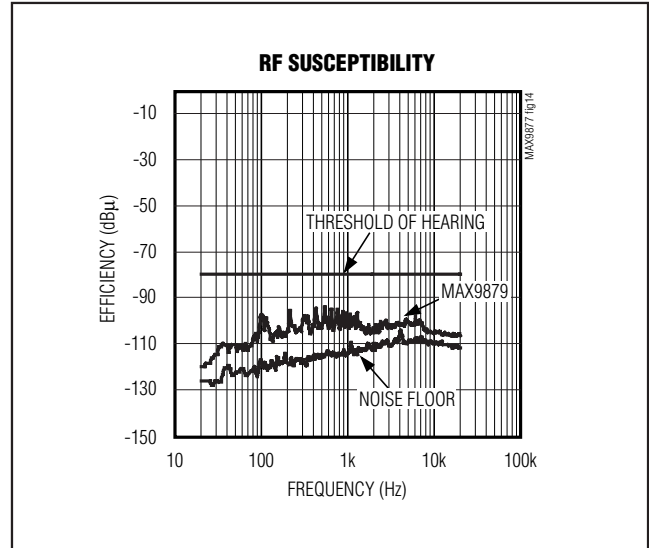

Figure 14. MAX9879 Susceptibility to a GSM Cell Phone Radio

PVDD Bulk Capacitor (C3)

In addition to the recommended PVDD bypass capacitance, bulk capacitance equal to C3 should be used. Place the bulk capacitor as close as possible to the device.

Supply Bypassing, Layout, and Grounding

Proper layout and grounding are essential for optimum performance. Use wide traces for the power-supply inputs and amplifier outputs to minimize losses due to parasitic trace resistance. Wide traces also aid in moving heat away from the package. Proper grounding improves audio performance, minimizes crosstalk between channels, and prevents any switching noise from coupling into the audio signal. Connect PGND and GND together at a single point on the PCB. Route all traces that carry switching transients away from GND and the traces/components in the audio signal path.

Connect the PVDD₋ pins to a 2.7V to 5.5V source. Bypass PVDD₋ to PGND pin with a 1 μ F ceramic capacitor. Additional bulk capacitance should be used to prevent power supply pumping. Bypass PVDD₋ to the PGND pin with a 1 μ F ceramic capacitor. Additional bulk capacitance should be used to prevent power-supply pumping. Place the bypass capacitors as close as possible to the MAX9879.

Connect V_{DD} to PVDD₋. Bypass V_{DD} to GND with a 1 μ F capacitor. Place the bypass capacitors as close as possible to the MAX9879.

MAX9879

Stereo Class D Audio Subsystem with DirectDrive Headphone Amplifier

RF Susceptibility

GSM radios transmit using time-division multiple access (TDMA) with 217Hz intervals. The result is an RF signal with strong amplitude modulation at 217Hz that is easily demodulated by audio amplifiers. Figure 14 shows the susceptibility of the MAX9879 to a transmitting GSM radio placed in close proximity. Although there is measurable noise at 217Hz and its harmonics, the noise is well below the threshold of hearing using typical headphones.

In RF applications, improvements to both layout and component selection decreases the MAX9879's susceptibility to RF noise and prevent RF signals from being demodulated into audible noise. Trace lengths should be kept below $1/4$ the wavelength of the RF frequency of interest. Minimizing the trace lengths prevents them from functioning as antennas and coupling RF signals into the MAX9879. The wavelength λ in meters is given by:

$$\lambda = c/f$$

where $c = 3 \times 10^8$ m/s, and f = the RF frequency of interest.

Route audio signals on middle layers of the PCB to allow ground planes above and below shield them from RF interference. Ideally the top and bottom layers of the PCB should primarily be ground planes to create effective shielding.

Additional RF immunity can also be obtained from relying on the self-resonant frequency of capacitors as it exhibits the frequency response similar to a notch filter. Depending on the manufacturer, 10pF to 20pF capacitors typically exhibit self resonance at RF frequencies. These capacitors, when placed at the input pins, can effectively shunt the RF noise at the inputs of the MAX9879. For these capacitors to be effective, they must have a low-impedance, low-inductance path to the ground plane. Do not use microvias to connect to the ground plane as these vias do not conduct well at RF frequencies.

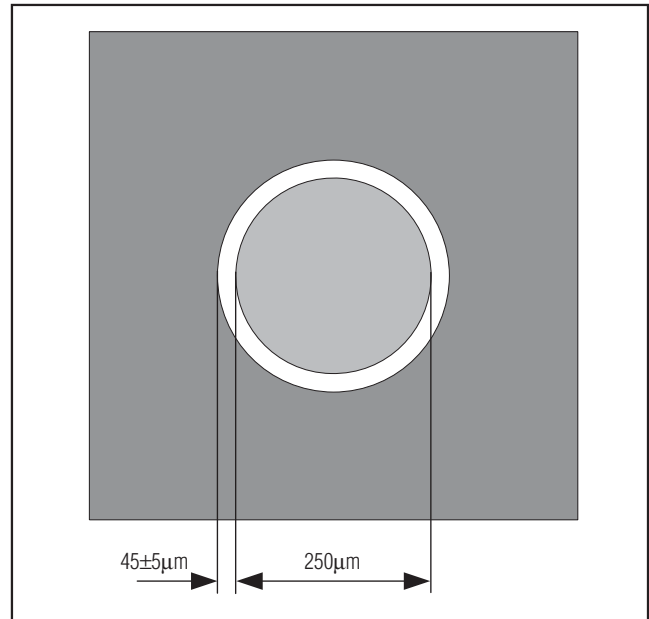

Figure 15. PCB Footprint Recommendation Diagram

UCSP Applications Information

For the latest application details on UCSP construction, dimensions, tape carrier information, PCB techniques, bump-pad layout, and recommended reflow temperature profile, as well as the latest information on reliability testing results, refer to the Application Note 1891: *Understanding the Basics of the Wafer-Level Chip-Scale Package (WL-CSP)* on Maxim's website at www.maxim-ic.com/ucsp. See Figure 15 for the recommended PCB footprint for the MAX9879.

MAX9879

Stereo Class D Audio Subsystem with DirectDrive Headphone Amplifier

Typical Application Circuit

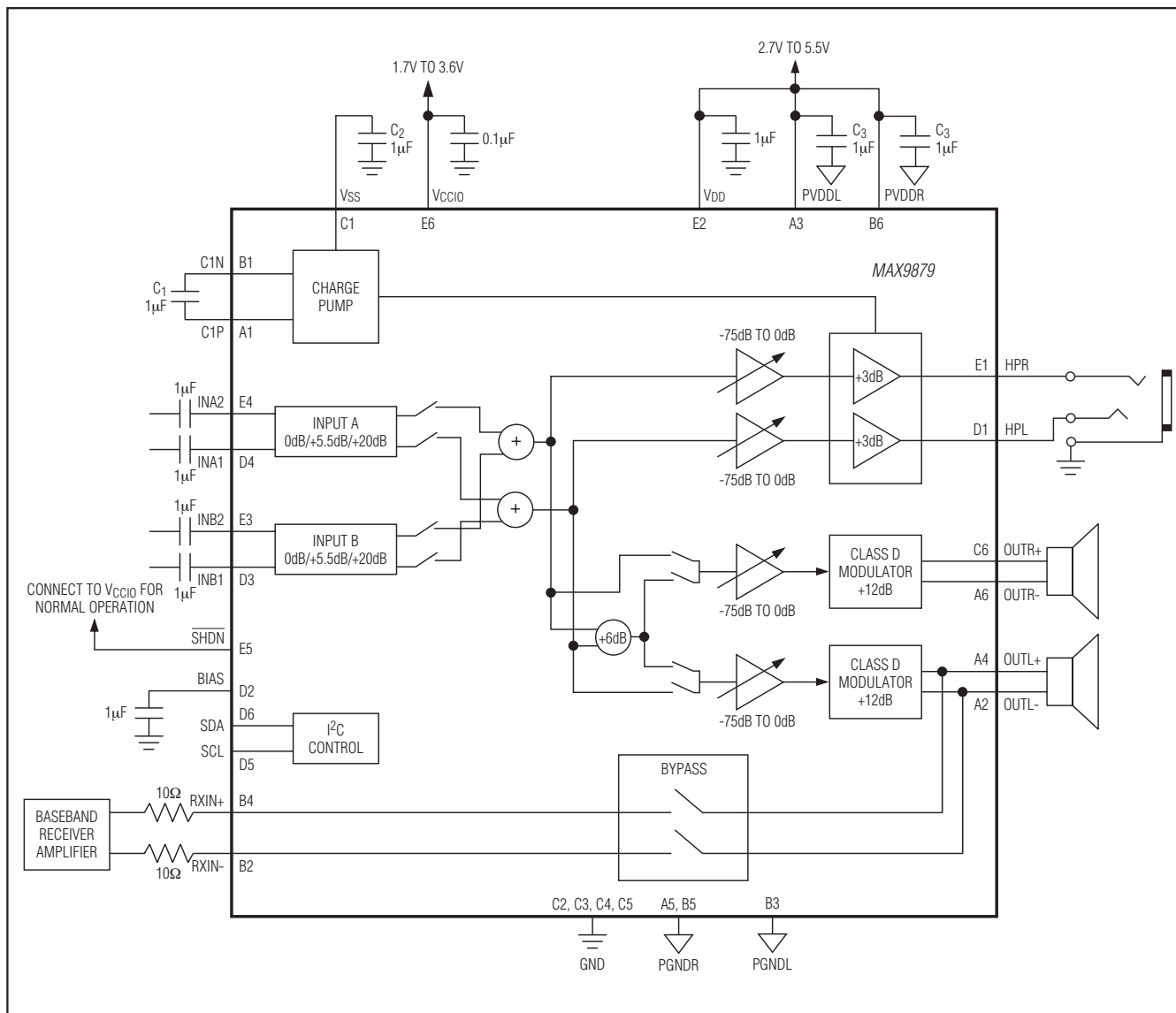

Chip Information

PROCESS: BiCMOS

MAX9879

Stereo Class D Audio Subsystem with DirectDrive Headphone Amplifier

Package Information

For the latest package outline information and land patterns (footprints), go to www.maximintegrated.com/packages. Note that a "+", "#", or "-" in the package code indicates RoHS status only. Package drawings may show a different suffix character, but the drawing pertains to the package regardless of RoHS status.

PACKAGE TYPE	PACKAGE CODE	OUTLINE NO.	LAND PATTERN NO.
30 NCSP	R302A3+1	21-0058	—

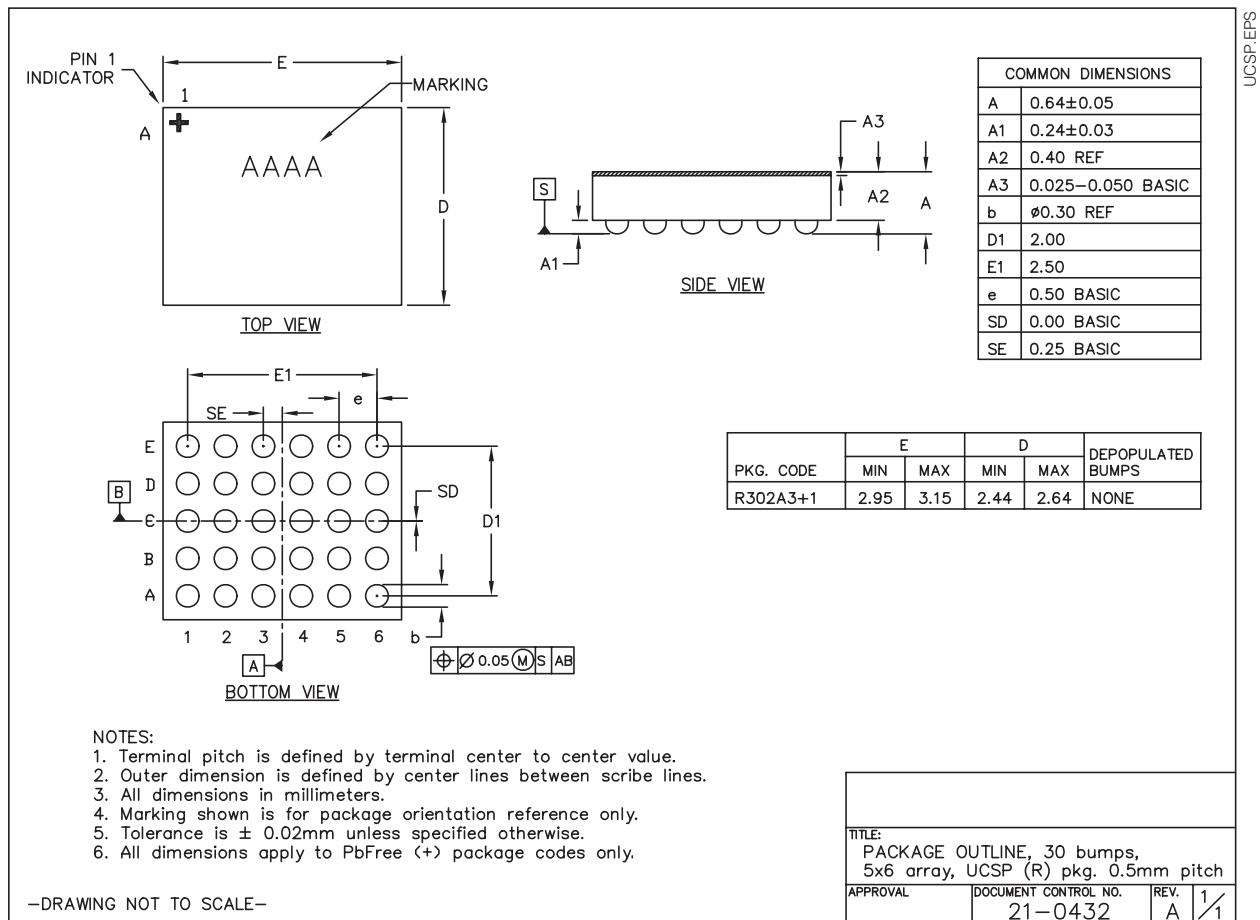

UCSP:EPS

MAX9879

Stereo Class D Audio Subsystem with DirectDrive Headphone Amplifier

Revision History

REVISION NUMBER	REVISION DATE	DESCRIPTION	PAGES CHANGED
0	2/09	Initial release	—
1	4/13	Updated maximum input signal swing and <i>Typical Application Circuit</i>	2, 30



Maxim Integrated cannot assume responsibility for use of any circuitry other than circuitry entirely embodied in a Maxim Integrated product. No circuit patent licenses are implied. Maxim Integrated reserves the right to change the circuitry and specifications without notice at any time. The parametric values (min and max limits) shown in the Electrical Characteristics table are guaranteed. Other parametric values quoted in this data sheet are provided for guidance.