

ESD5305FB

**4-Lines, Uni-directional, Low Capacitance
Transient Voltage Suppressors**

<http://www.sh-willsemi.com>

Descriptions

The ESD5305FB is a low capacitance TVS (Transient Voltage Suppressor) array designed to protect high speed data interfaces. It has been specifically designed to protect sensitive electronic components which are connected to data and transmission lines from over-stress caused by ESD (Electrostatic Discharge).

The ESD5305FB incorporates four pairs of low capacitance steering diodes plus a TVS diode.

The ESD5305FB may be used to provide ESD protection up to $\pm 30\text{kV}$ (contact discharge) according to IEC61000-4-2, and withstand peak pulse current up to 6A (8/20 μs) according to IEC61000-4-5.

The ESD5305FB is available in SOT23-6L package. Standard products are Pb-free and Halogen-free.

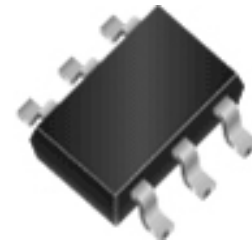

SOT23-6L

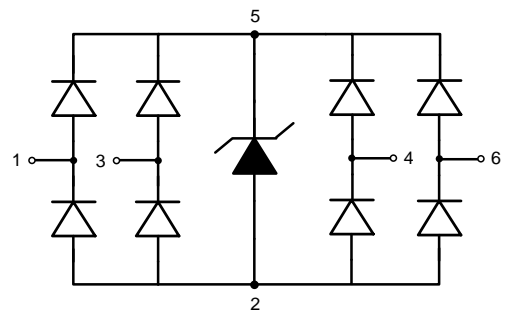

Circuit diagram

Features

- Reverse stand-off voltage: 5V max.
- Transient protection for each line according to IEC61000-4-2 (ESD): $\pm 30\text{kV}$ (contact discharge)
IEC61000-4-5 (surge): 6A (8/20 μs)
- Low capacitance: $C_{I/O-GND} = 0.65\text{pF}$ typ. (VDD = floated)
 $C_{I/O-GND} = 0.35\text{pF}$ typ. (VDD = 5V)
- Ultra-low leakage current: $I_R < 1\text{nA}$ typ.
- Low clamping voltage: $V_{CL} = 12.8\text{V}$ @ $I_{PP} = 16\text{A}$ (TLP)
- Solid-state silicon technology

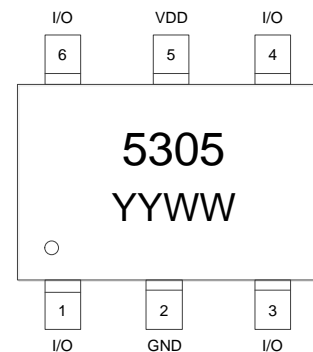

5305 = Device code
YY = Year code
WW = Week code

Marking & Pin configuration (Top View)

Applications

- USB 2.0
- HDMI 1.3
- SATA and eSATA
- DVI
- IEEE 1394
- PCI Express
- Portable Electronics
- Notebooks

Order information

Device	Package	Shipping
ESD5305FB-6/TR	SOT23-6L	3000/Tape&Reel

Absolute maximum ratings

Parameter	Symbol	Rating	Unit
Peak pulse power ($t_p = 8/20\mu s$)	P_{pk}	84	W
Peak pulse current ($t_p = 8/20\mu s$)	I_{PP}	6	A
ESD according to IEC61000-4-2 air discharge	V_{ESD}	± 30	kV
ESD according to IEC61000-4-2 contact discharge		± 30	
Junction temperature	T_J	125	$^{\circ}C$
Operation temperature	T_{OP}	-40 to 85	$^{\circ}C$
Storage temperature	T_{STG}	-55 to 150	$^{\circ}C$
Lead temperature	T_L	260	$^{\circ}C$

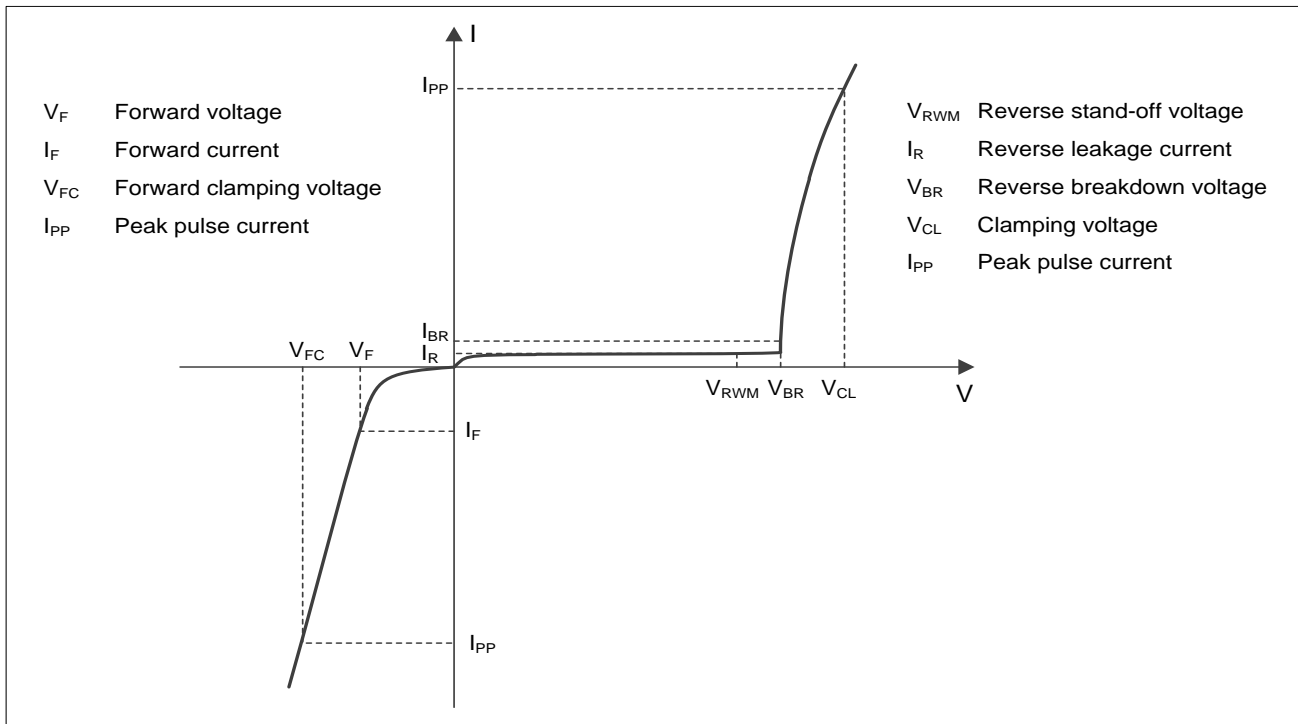
Electrical characteristics ($T_A = 25^{\circ}C$, unless otherwise noted)

Definitions of electrical characteristics

Electrical characteristics (T_A = 25°C, unless otherwise noted)

Parameter	Symbol	Condition	Min.	Typ.	Max.	Unit
Reverse stand-off voltage	V _{RWM}				5.0	V
Reverse leakage current	I _R	V _{RWM} = 5V		<1	50	nA
Reverse breakdown voltage	V _{BR}	I _{BR} = 1mA	7.0	8.0	9.0	V
Forward voltage	V _F	I _F = 10mA	0.6	0.9	1.2	V
Clamping voltage ¹⁾	V _{CL}	I _{PP} = 16A, t _p = 100ns		12.8		V
Dynamic resistance ¹⁾	R _{DYN}			0.24		Ω
Clamping voltage ²⁾	V _{CL}	I _{PP} = 1A, t _p = 8/20μs			10	V
		I _{PP} = 6A, t _p = 8/20μs			14	V
Junction capacitance	C _{I/O - GND}	V _R = 0V, f = 1MHz, VDD = floated, any I/O to GND		0.65	1.0	pF
		V _R = 0V, f = 1MHz, VDD = 5V, any I/O to GND		0.35	0.50	pF
	C _{I/O - I/O}	V _R = 0V, f = 1MHz, any I/O to I/O		0.35	0.50	pF

Notes:

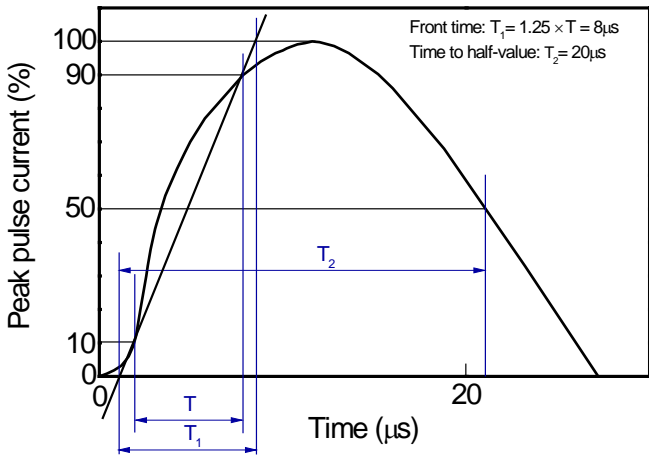
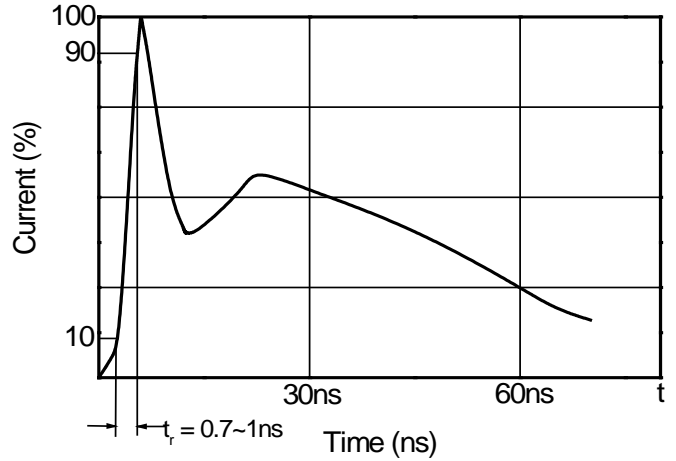
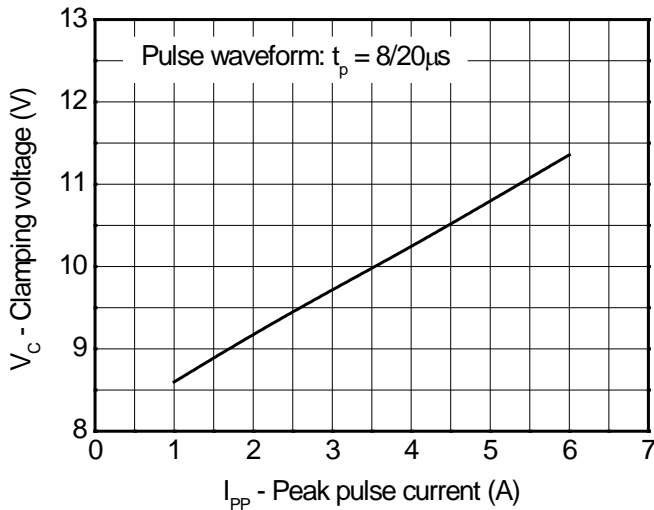
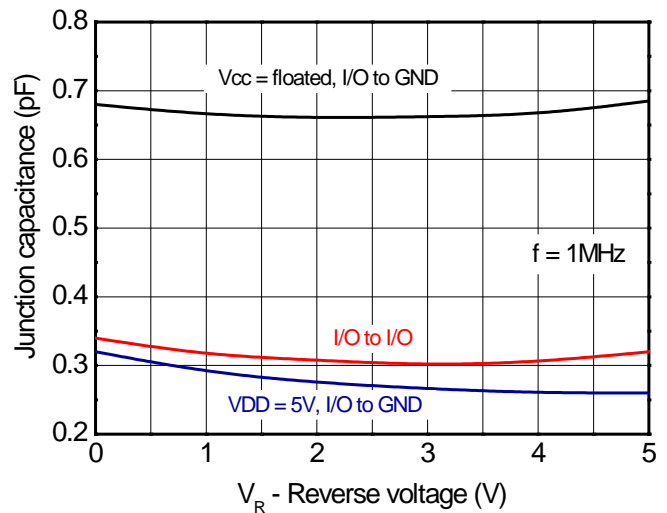
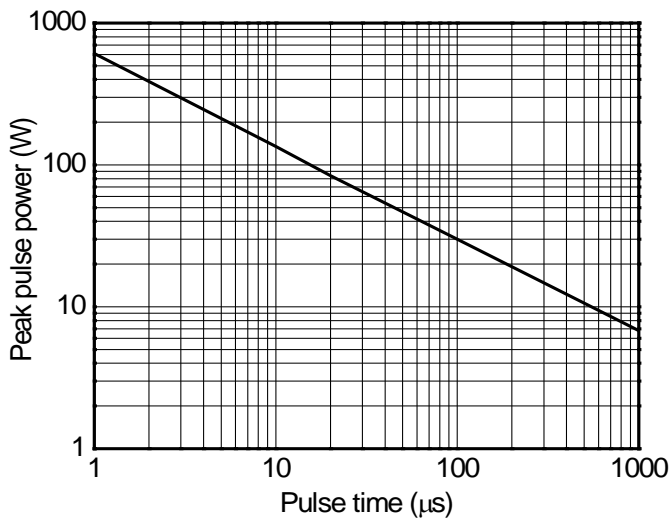
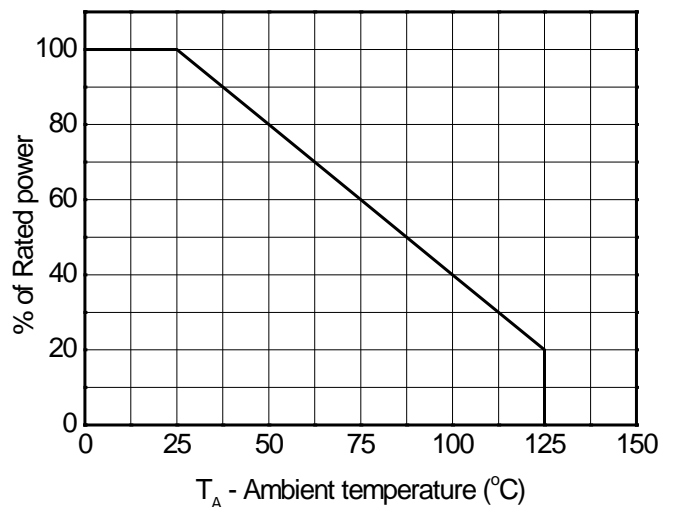
- 1) TLP parameter: Z₀ = 50Ω, t_p = 100ns, t_r = 2ns, averaging window from 60ns to 80ns. R_{DYN} is calculated from 10A to 30A.
- 2) Non-repetitive current pulse, according to IEC61000-4-5.

Typical characteristics ($T_A = 25^\circ\text{C}$, unless otherwise noted)

8/20µs waveform per IEC61000-4-5

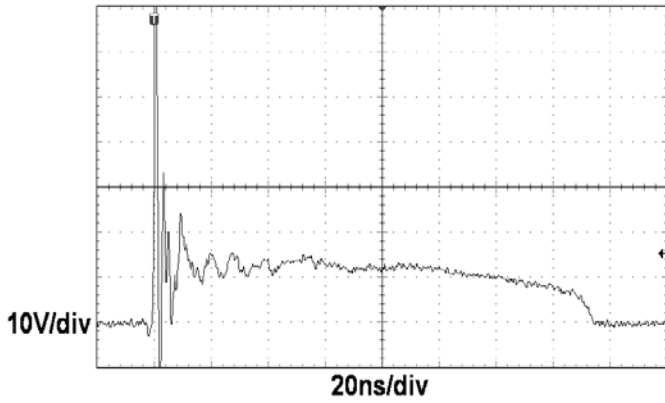
Contact discharge current waveform per IEC61000-4-2

Clamping voltage vs. Peak pulse current

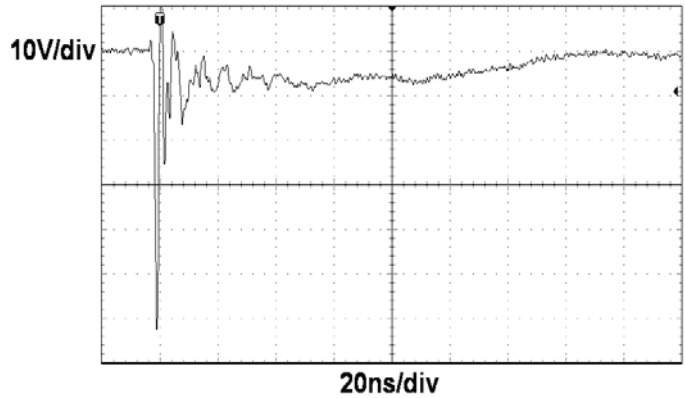
Capacitance vs. Reverse voltage

Non-repetitive peak pulse power vs. Pulse time

Power derating vs. Ambient temperature

Typical characteristics ($T_A = 25^\circ\text{C}$, unless otherwise noted)



ESD clamping
(+8kV contact discharge per IEC61000-4-2)



ESD clamping
(-8kV contact discharge per IEC61000-4-2)

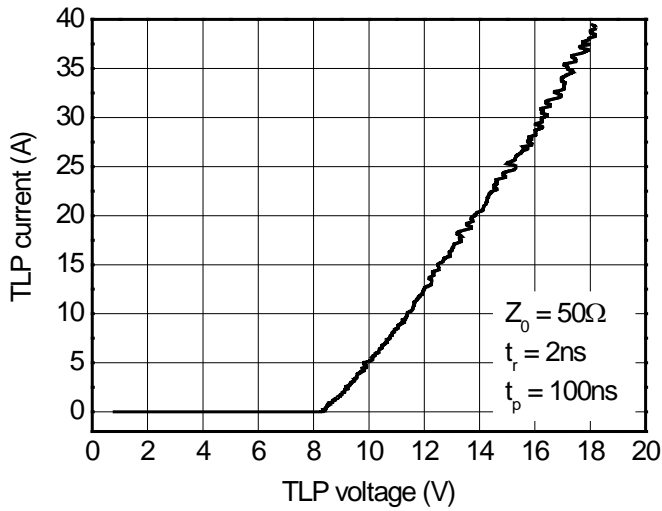

TLP Measurement

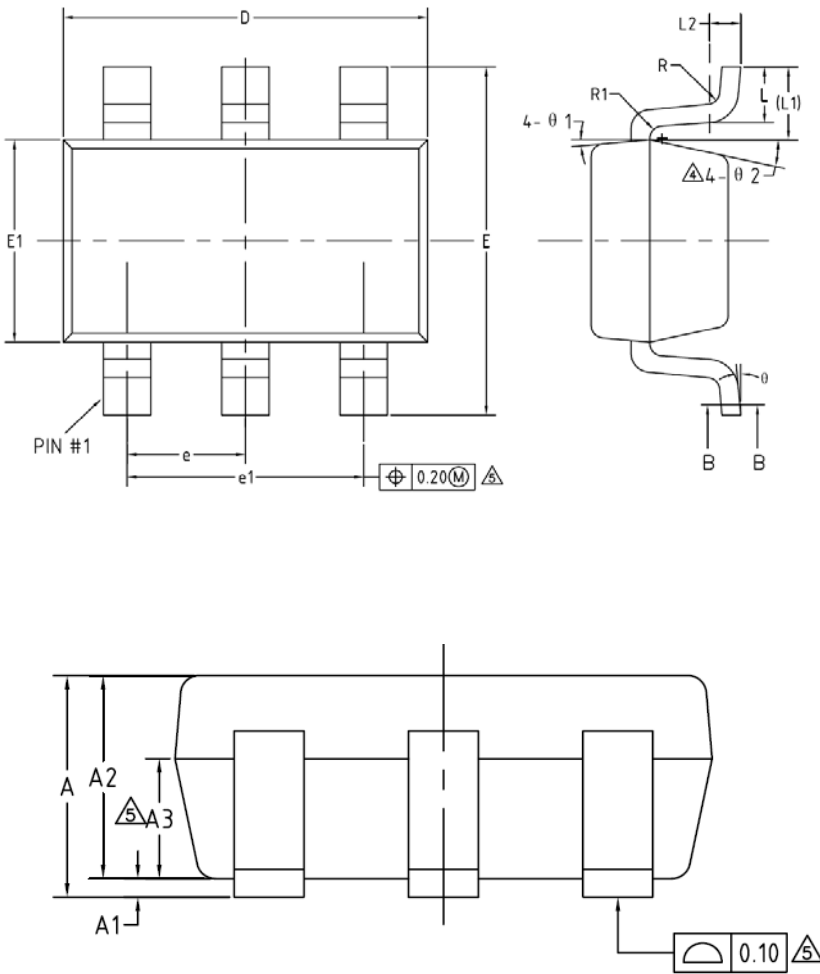
Package outline dimensions
SOT23-6L

Symbol	Dimensions In Millimeters		
	Min.	Typ.	Max.
A	--	--	1.250
A1	0.000	--	0.150
A2	1.000	1.100	1.200
A3	0.600	0.650	0.700
b	0.360	--	0.500
b1	0.360	0.380	0.450
c	0.140	--	0.200
c1	0.140	0.150	0.160
D	2.826	2.926	3.026
E	2.600	2.800	3.000
E1	1.526	1.626	1.726
e	0.900	0.950	1.000
e1	1.800	1.900	2.000
L	0.350	0.450	0.600
L1	0.590REF		
L2	0.250BSC		
R	0.100	--	--
R1	0.100	--	0.200
θ	0°	--	8°
θ1	3°	5°	7°
θ2	6°	--	14°

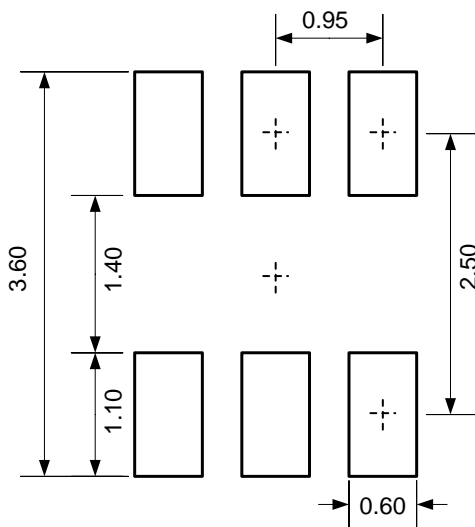
Recommended land pattern (Unit: mm)

Notes:

This recommended land pattern is for reference purposes only. Please consult your manufacturing group to ensure your PCB design guidelines are met.