



IM12-04N-N-ZW0

IMN

INDUCTIVE PROXIMITY SENSORS

**SICK**  
Sensor Intelligence.



### Ordering information

Type	Part no.
IM12-04N-N-ZW0	6021125

Other models and accessories → [www.sick.com/IMN](http://www.sick.com/IMN)

Illustration may differ



### Detailed technical data

#### Features

<b>Housing</b>	Cylindrical thread design
<b>Thread size</b>	M12 1
<b>Diameter</b>	Ø 12 mm
<b>Sensing range <math>S_n</math></b>	4 mm
<b>Safe sensing range <math>S_a</math></b>	3.24 mm
<b>Installation type</b>	Non-flush
<b>Switching frequency</b>	1,500 Hz
<b>Connection type</b>	Cable, 2-wire, 2 m
<b>Switching output</b>	NAMUR
<b>Output function</b>	NC
<b>Enclosure rating</b>	IP67 <sup>1)</sup>

<sup>1)</sup> According to EN 60529.

#### Mechanics/electronics

<b>Supply voltage</b>	7.5 V DC ... 25 V DC <sup>1)</sup>
<b>Current consumption</b>	≤ 30 mA <sup>1)</sup>
<b>Hysteresis</b>	1 % ... 15 %
<b>Temperature drift (of <math>S_n</math>)</b>	± 10 %
<b>EMC</b>	According to EN 60947-5-6
<b>Current consumption, sensor is activated</b>	≤ 1 mA
<b>Current consumption, sensor is not activated</b>	≥ 2.2 mA
<b>Cable material</b>	PVC

<sup>1)</sup> When used outside the hazardous area.

<sup>2)</sup> For connection to a separately certified intrinsically safe circuit only.

<sup>3)</sup> 1 kΩ.

<b>Conductor size</b>	0.34 mm <sup>2</sup>
<b>Cable diameter</b>	Ø 4.9 mm
<b>Cable resistance</b>	50 Ω
<b>Shock and vibration resistance</b>	30 g, 11 ms / 10 ... 55 Hz, 1 mm
<b>Ambient operating temperature</b>	-20 °C ... +70 °C
<b>Housing material</b>	Metal, Nickel-plated brass
<b>Sensing face material</b>	Plastic, Plastic
<b>Housing length</b>	30 mm
<b>Thread length</b>	25 mm
<b>Tightening torque, max.</b>	7 Nm
<b>Weight</b>	127 g
<b>Items supplied</b>	Fastening nuts (2x); width across 17, metal
<b>EC Approval Certificate</b>	PTB 03 ATEX 2037
<b>Ex area category</b>	1G
<b>Input voltage U<sub>i</sub> max.</b>	15 V <sup>2)</sup>
<b>Input power P<sub>i</sub> max.</b>	120 mW <sup>2)</sup>
<b>Input current I<sub>i</sub> max.</b>	50 mA <sup>2)</sup>
<b>Internal capacitance C<sub>i</sub> max.</b>	140 nF <sup>2)</sup>
<b>Internal inductance L<sub>i</sub> max.</b>	130 μH <sup>2)</sup>
<b>Nominal voltage</b>	8.2 V DC <sup>3)</sup>
<b>Device labeling</b>	II 1G Ex ia IIC T6 Ga Ta -20 °C ... +70 °C

<sup>1)</sup> When used outside the hazardous area.

<sup>2)</sup> For connection to a separately certified intrinsically safe circuit only.

<sup>3)</sup> 1 kΩ.

## Reduction factors

<b>Note</b>	The values are reference values which may vary
<b>Stainless steel (V2A, 304)</b>	Approx. 0.7
<b>Aluminum (Al)</b>	Approx. 0.4
<b>Copper (Cu)</b>	Approx. 0.3
<b>Brass (Br)</b>	Approx. 0.5

## Installation note

<b>Remark</b>	Associated graphic see "Installation"
<b>A</b>	12 mm
<b>B</b>	24 mm
<b>C</b>	12 mm
<b>D</b>	12 mm
<b>E</b>	8 mm
<b>F</b>	32 mm

## Classifications

<b>ECI@ss 5.0</b>	27270101
-------------------	----------

<b>ECl@ss 5.1.4</b>	27270101
<b>ECl@ss 6.0</b>	27270101
<b>ECl@ss 6.2</b>	27270101
<b>ECl@ss 7.0</b>	27270101 </td
<b>ECl@ss 8.0</b>	27270101
<b>ECl@ss 8.1</b>	27270101
<b>ECl@ss 9.0</b>	27270101
<b>ETIM 5.0</b>	EC002714
<b>ETIM 6.0</b>	EC002714
<b>UNSPSC 16.0901</b>	39122230

**Installation note**

Non-flush installation

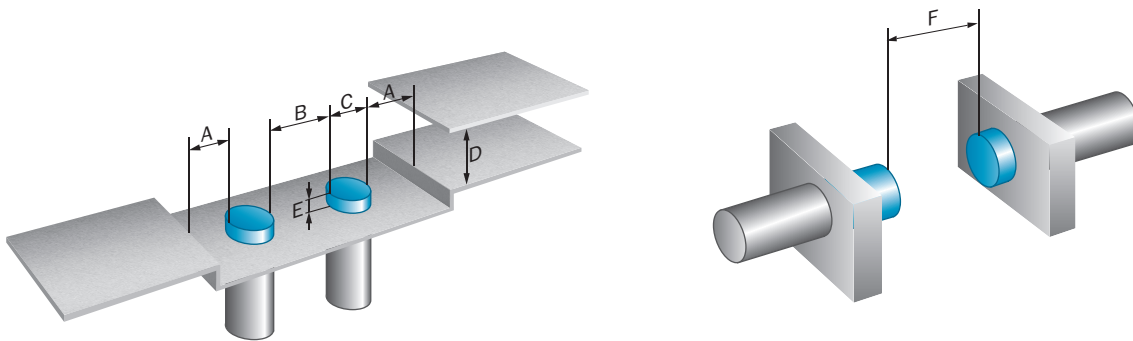

**Connection diagram**

Cd-012

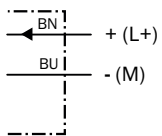

**Dimensional drawing** (Dimensions in mm (inch))



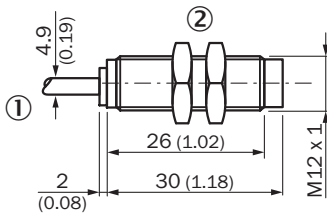

IM12 Namur, non flush



- ① Connection
- ② Fastening nuts (2x); width across 17, metal

**Recommended accessories**

Other models and accessories → [www.sick.com/IMN](http://www.sick.com/IMN)

	<b>Brief description</b>	<b>Type</b>	<b>Part no.</b>
<b>Universal bar clamp systems</b>			
	Plate N05 for universal clamp bracket, M12, Zinc plated steel (sheet), Zinc die cast (clamping bracket), Universal clamp (5322626), mounting hardware	BEF-KHS-N05	2051611
<b>Mounting brackets and plates</b>			
	Mounting plate for M12 sensors, steel, zinc coated, without mounting hardware	BEF-WG-M12	5321869
	Mounting bracket for M12 sensors, steel, zinc coated, without mounting hardware	BEF-WN-M12	5308447
<b>Modules and gateways</b>			
	NAMUR isolatig amplifier, Cable fault detection, Switching outputs: 2 NO relay (1 per channel), Supply voltage: 24 V ... 230 V, Voltage type: AC/DC	EN2-2EX1	6041096

## SICK AT A GLANCE

SICK is one of the leading manufacturers of intelligent sensors and sensor solutions for industrial applications. A unique range of products and services creates the perfect basis for controlling processes securely and efficiently, protecting individuals from accidents and preventing damage to the environment.

We have extensive experience in a wide range of industries and understand their processes and requirements. With intelligent sensors, we can deliver exactly what our customers need. In application centers in Europe, Asia and North America, system solutions are tested and optimized in accordance with customer specifications. All this makes us a reliable supplier and development partner.

Comprehensive services complete our offering: SICK LifeTime Services provide support throughout the machine life cycle and ensure safety and productivity.

For us, that is “Sensor Intelligence.”

## WORLDWIDE PRESENCE:

Contacts and other locations –[www.sick.com](http://www.sick.com)