

LUXEON F ES Cool White

Industry-leading solutions for light guide DRL, and signature lamps

LUXEON F ES Cool White LEDs are the only automotive LEDs that deliver design flexibility and advanced functionality. These products, with their miniaturized form factor, are designed to support daytime running lights, front fog and low and high beam applications. The Lumileds automotive binning structure meets both SAE and ECE color specifications and is hot binned at 85°C, consistent with actual automotive operational environments. LUXEON F ES Cool White provides an industry-leading solution for your front automotive lights applications. All LUXEON F LEDs are IEC-60810 qualified.

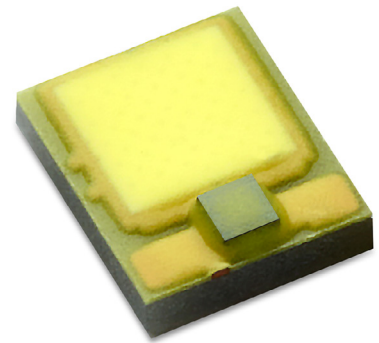
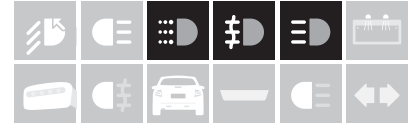

FEATURES AND BENEFITS

- Higher drive current capability for increased flux performance
- Low thermal resistance for better hot lumen performance
- Standard packaging for low cost and ease of manufacturability
- Hot binned at 85°C monopulse (MP) to match closer to operating conditions
- IEC/PAS 62707-1 White LED

PRIMARY APPLICATIONS

- Daytime Running Lights
- Front Fog
- Headlight

Table of Contents

General Product Information	2
Product Test Conditions	2
Part Number Nomenclature	2
Environmental Compliance	2
Performance Characteristics	3
Product Selection Guide	3
Optical Characteristics	3
Electrical and Thermal Characteristics	3
Absolute Ratings	4
JEDEC Moisture Sensitivity	4
Characteristic Curves	5
Spectral Power Distribution Characteristics	5
Light Output Characteristics	5
Forward Current and Voltage Characteristics	6
Color Shift Characteristics	7
Radiation Pattern Characteristics	8
Operating Limits Characteristics	9
Permissible Pulse Handling Characteristics	9
Product Bin and Labeling Definitions	10
Designing with LUXEON F ES Cool White	10
Decoding Product Bin Labeling	10
Luminous Flux Bins	10
Color Codes	11
Color Bin Definitions	12
Forward Voltage Bins	13
Mechanical Dimensions	13
Packaging Information	14
Pocket Tape Dimensions	14
Reel Dimensions	14

General Product Information

Product Test Conditions

LUXEON F ES Cool White LEDs are tested and binned using a 20ms monopulse (MP) at 700mA drive current, case temperature, T_c , of 85°C.

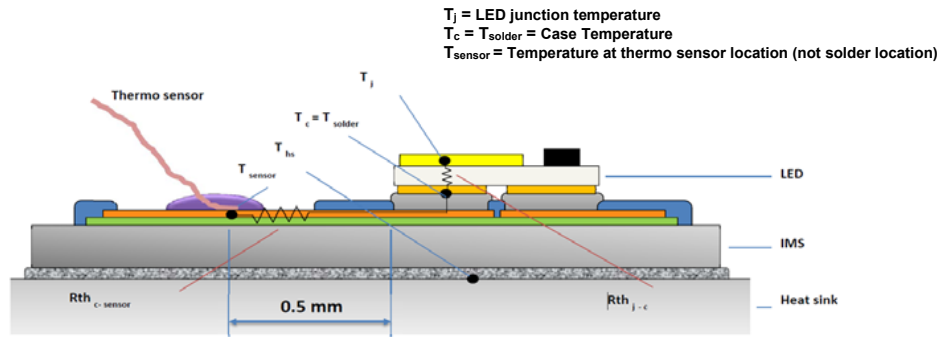

Figure 1. Example of case temperature location on sample board for LUXEON F ES Cool White.

Part Number Nomenclature

Part numbers for LUXEON F ES Cool White follow the convention below:

L F X H – A B C – E F G H

Where:

- L – designates LUXEON
- F – designates LUXEON F product family
- X H – designates hot binning
- A – designates color variant (C=White)
- B – designates die size (2=2mm²)
- C – designates binning current (B=700mA)
- E – designates future product offerings
- F G H – designates minimum luminous flux

Therefore, the following part number is used for a LUXEON F ES Cool White with a minimum luminous flux of 220 lumens:

L F X H – C 2 B – 0 2 2 0

Environmental Compliance

Lumileds LLC is committed to providing environmentally friendly products to the solid-state lighting market. LUXEON F ES Cool White is compliant to the European Union directives on the restriction of hazardous substances in electronic equipment, namely the RoHS Directive 2011/65/EU and REACH Regulation (EC) 1907/2006. Lumileds LLC will not intentionally add the following restricted materials to its products: lead, mercury, cadmium, hexavalent chromium, polybrominated biphenyls (PBB) or polybrominated diphenyl ethers (PBDE).

Performance Characteristics

Product Selection Guide

Table 1. Product selection for LUXEON F ES Cool White at 20ms MP test current, $T_c=85^\circ\text{C}$.

MINIMUM LUMINOUS FLUX ^[1] (lm)	TEST CURRENT (mA)	PART NUMBER
220	700	LFXH-C2B-0220
240	700	LFXH-C2B-0240
260	700	LFXH-C2B-0260

Notes for Table 1:

- Lumileds maintains a tolerance of $\pm 6.5\%$ on luminous flux measurements.

Optical Characteristics

Table 2. Typical optical characteristics for LUXEON F ES Cool White at 20ms MP test current, $T_c=85^\circ\text{C}$.

PART NUMBER	CORRELATED COLOR TEMPERATURE		TOTAL INCLUDED ANGLE ^[1] $\theta_{0.90V}$	VIEWING ANGLE ^[2] $2\theta_{1/2}$
	MINIMUM	MAXIMUM		
LFXH-C2B-0xxx	5500K	6680K	140°	120°

Notes for Table 2:

- Total angle at which 90% of total luminous flux is captured.
- Viewing angle is the off axis angle from the LED centerline where the luminous intensity is $\frac{1}{2}$ of the peak value.

Electrical and Thermal Characteristics

Table 3. Electrical characteristics for LUXEON F ES Cool White at 20ms MP test current, $T_c=85^\circ\text{C}$.

PART NUMBER	FORWARD VOLTAGE ^[1] (V_f)		DYNAMIC RESISTANCE ^[2] (Ω) R_D	TEMPERATURE COEFFICIENT OF FORWARD VOLTAGE ^[3] ($\text{mV}/^\circ\text{C}$) $\Delta V_f / \Delta T_j$	TYPICAL THERMAL RESISTANCE— JUNCTION TO CASE ($^\circ\text{C}/\text{W}$)			
	MINIMUM	MAXIMUM			$R\theta_{j-c,el}$ ^[4]		$R\theta_{j-c,real}$ ^[5]	
					TYPICAL	MAXIMUM	TYPICAL	MAXIMUM
LFXH-C2B-0xxx	2.55	3.27	0.3	-2.1	2.4	2.7	3.4	3.8

Notes for Table 3:

- Lumileds maintains a tolerance of $\pm 0.06\text{V}$ on forward voltage measurements.
- Dynamic resistance is the inverse of the slope in linear forward voltage model for LEDs (see Figure 4a. Typical forward current vs. forward voltage).
- Measured between $T_c=80^\circ\text{C}$ and $T_c=90^\circ\text{C}$ at binning current.
- $R\theta_{j-c,el}$: Electrical thermal resistance (junction to case).
- $R\theta_{j-c,real}$: Real thermal resistance (junction to case) with wall plug efficiency included. Reference JESD51-51, JESD51-14, 4.1.3.

Absolute Ratings

Table 4. Absolute ratings for LUXEON F ES Cool White.

PARAMETER	PERFORMANCE
Minimum DC Forward Current	50mA
Maximum DC Forward Current	1000mA
Maximum Junction Temperature ^[1]	150°C
Operating Case Temperature at Test Current ^[1]	-40°C to 120°C
Operating Case Temperature at Maximum Current ^[1]	-40°C to 120°C
LED Storage Temperature	-40°C to 130°C
Maximum Soldering Temperature	260°C
Allowable Reflow Cycles	3
ESD Sensitivity ^[2]	±8kV HBM, ±400V MM, ±2kV CDM
Reverse Voltage ($V_{reverse}$)	LUXEON F LEDs are not designed to be driven in reverse bias
Autoclave Conditions	121°C at 2 ATM 100% Relative Humidity for 96 Hours Maximum

Notes for Table 4:

1. Proper current derating must be observed to maintain junction temperature below the maximum. LUXEON F LEDs driven at or above maximum LED case temperature may have a shorter lifetime.
2. Measured using human body model (per JESD22 A114), machine model (per JESD22 A115) and charged device model (per JESD22 C101).

JEDEC Moisture Sensitivity

Table 5. Moisture sensitivity levels for LUXEON F ES Cool White.

LEVEL	FLOOR LIFE		STANDARD SOAK REQUIREMENT	
	TIME	CONDITIONS	TIME	CONDITIONS
1	Unlimited	≤30°C / 85% RH	168 Hours +5 / -0	85°C / 85% RH

Characteristic Curves

Spectral Power Distribution Characteristics

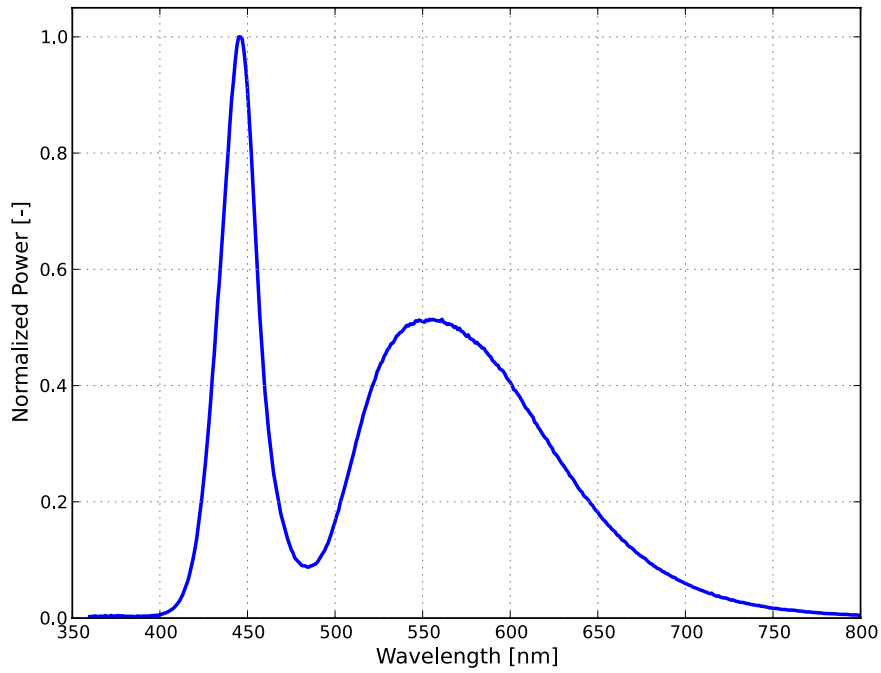

Figure 2. Typical normalized power vs. wavelength for LUXEON F ES Cool White at 20ms MP, 700mA, $T_c=85^{\circ}\text{C}$.

Light Output Characteristics

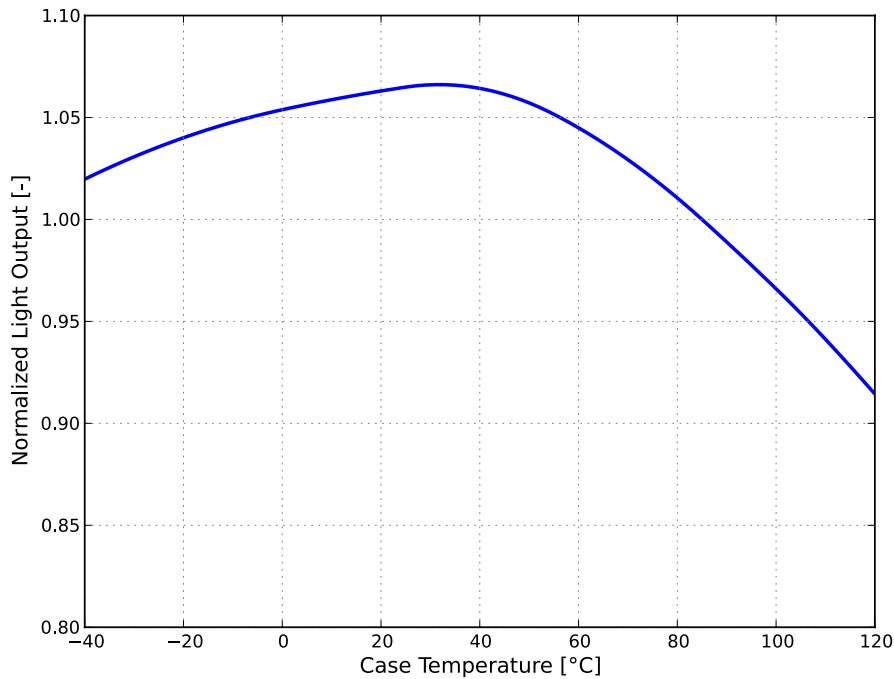

Figure 3a. Typical normalized light output vs. case temperature for LUXEON F ES Cool White at 20ms MP, 700mA.

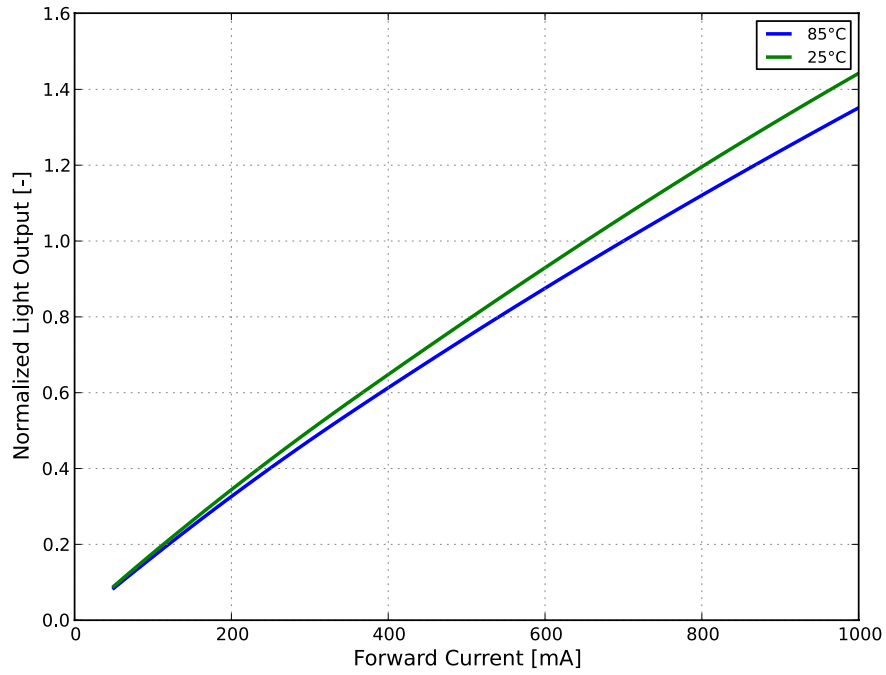

Figure 3b. Typical normalized light output vs. forward current for LUXEON F ES Cool White at $T_c=85^\circ\text{C}$.

Forward Current and Voltage Characteristics

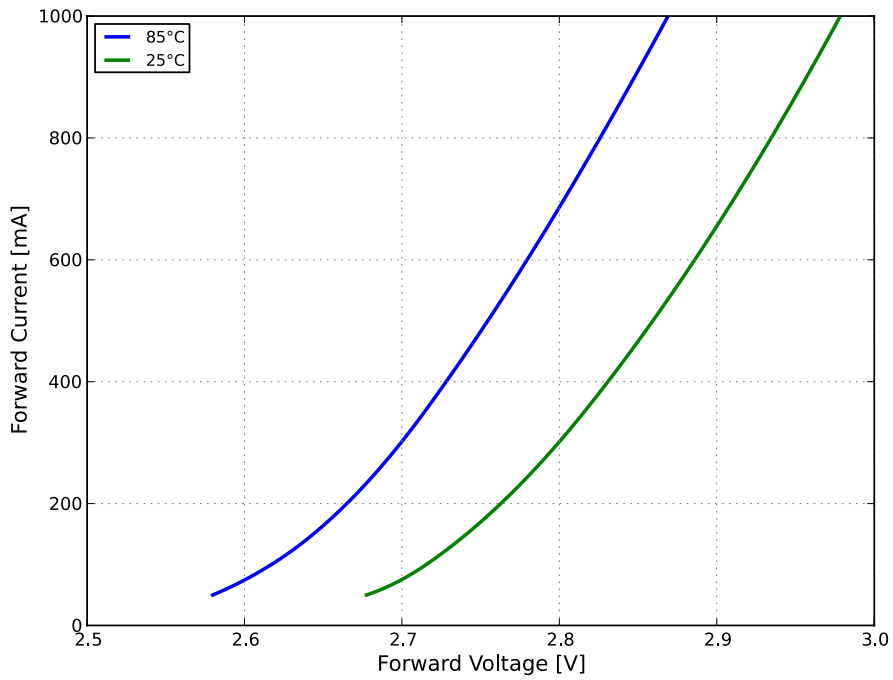

Figure 4a. Typical forward current vs. forward voltage for LUXEON F ES Cool White at $T_c=85^\circ\text{C}$.

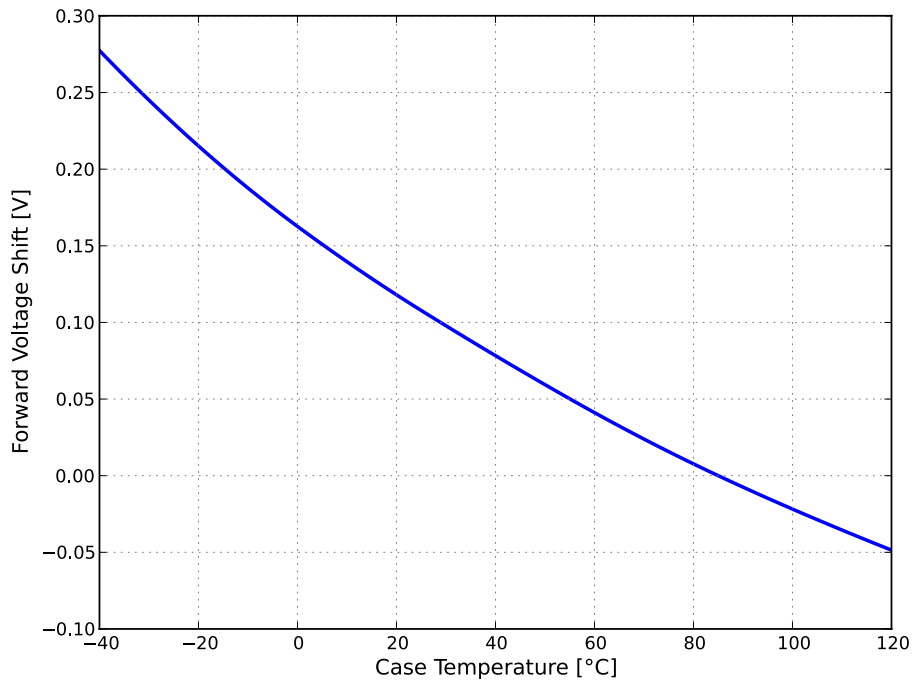

Figure 4b. Typical forward voltage shift vs. case temperature for LUXEON F ES Cool White.

Color Shift Characteristics

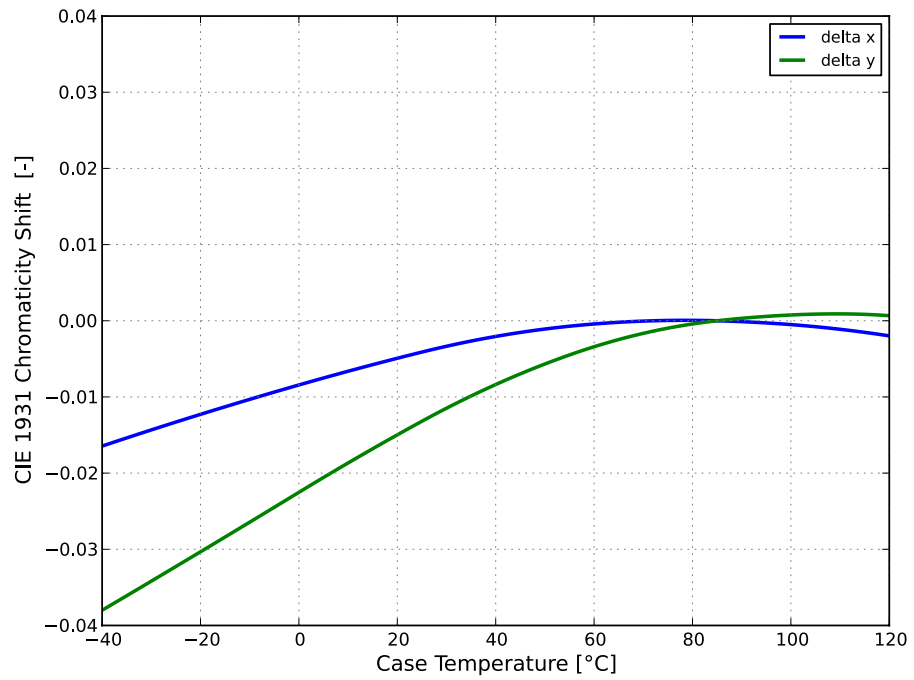

Figure 5a. Typical color shift in CIE 1931 x and y coordinates for LUXEON F ES Cool White at 20ms MP, 700mA.

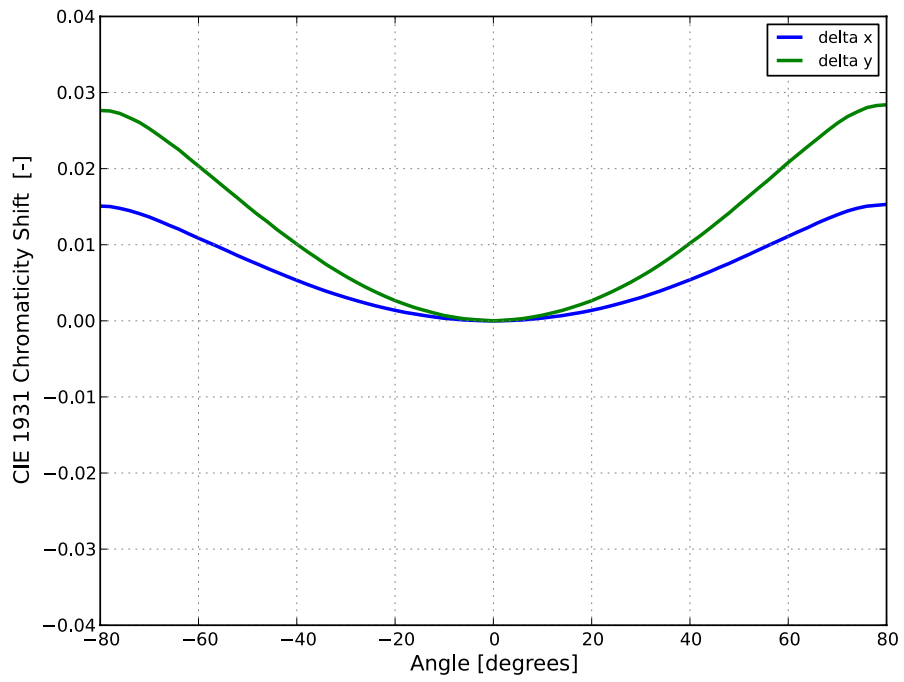

Figure 5b. Typical color shift in CIE 1931 x and y coordinates over angle for LUXEON F ES Cool White at 20ms MP, 700mA.

Radiation Pattern Characteristics

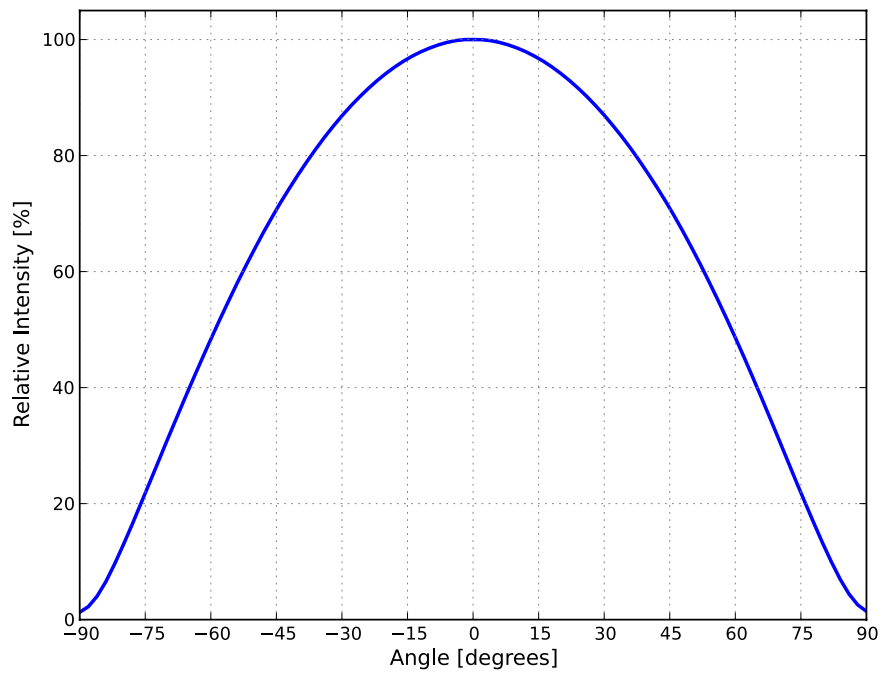

Figure 6. Typical radiation pattern for LUXEON F ES Cool White at 20ms MP, 700mA, $T_c=85^\circ\text{C}$.

Operating Limits Characteristics

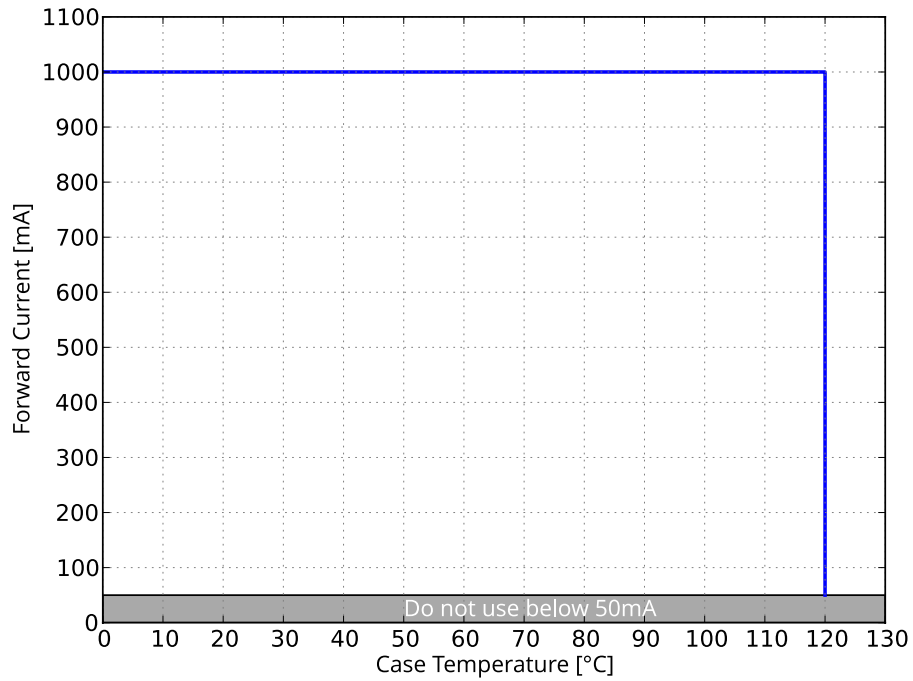

Figure 7. Maximum forward current vs. case temperature for LUXEON F ES Cool White.

Permissible Pulse Handling Characteristics

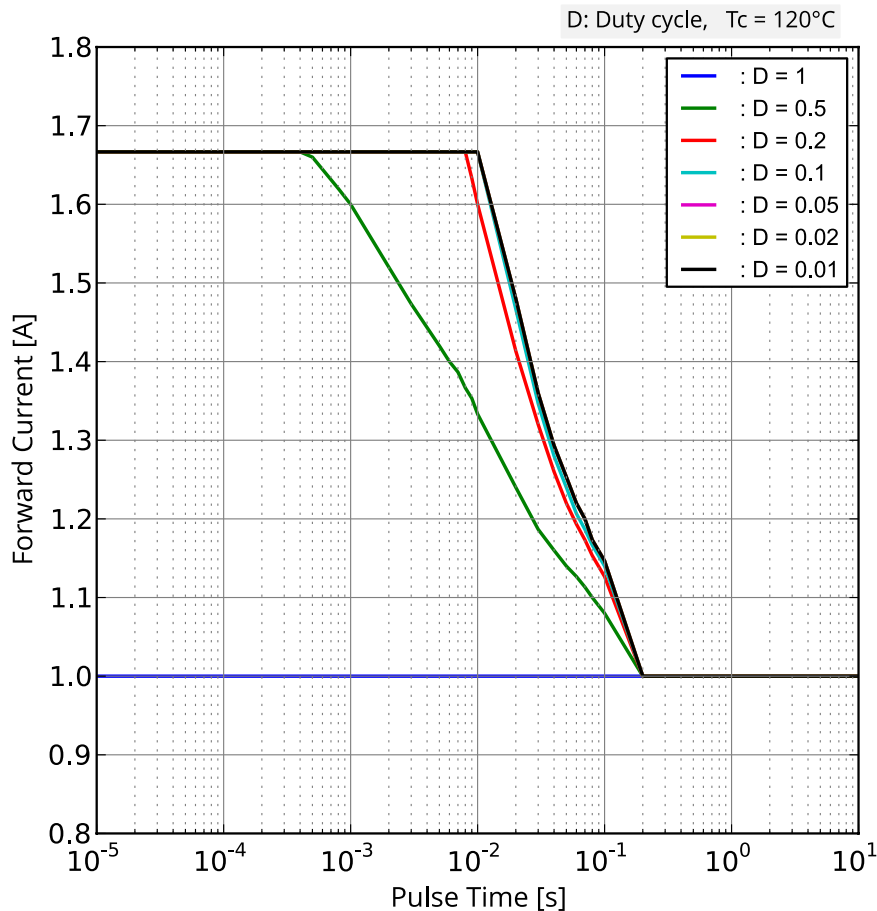

Figure 8. Permissible pulse handling capability for LUXEON F ES Cool White, $T_c = 120^\circ\text{C}$.

Product Bin and Labeling Definitions

Designing with LUXEON F ES Cool White

Flux bins supportable for car programs depend on product color, program start and end of production date. Flux roadmaps by year and product color are maintained and available from the sales representative. Please contact your local sales representative to request the flux bin range with best supportability for program timing.

Decoding Product Bin Labeling

In the manufacturing of semiconductor products, there are variations in performance around the average values given in the technical datasheets. For this reason, Lumileds bins the LED components for luminous flux, color and forward voltage.

LUXEON F ES Cool White LEDs are labeled using a 4-digit alphanumeric CAT code following the format below:

A B C D

Where:

- A** – designates luminous flux bin (example: T=220 to 240 lumens)
- B C** – designates color bin (example: 1A, 1B, 1C, 1D)
- D** – designates forward voltage bin (example: B=2.55V to 2.79V)

Therefore, a LUXEON F ES Cool White with a lumen range of 220 to 240, color bin of 1D, and a forward voltage range of 2.55V to 2.79V has the following CAT code:

T 1 D B

Luminous Flux Bins

Table 6 lists the standard luminous flux bins for LUXEON F emitters. Although several bins are outlined, product availability in a particular bin varies by production run and by product performance. Not all bins are available in all colors.

Table 6. Luminous flux bin definitions for LUXEON F ES Cool White at 20ms MP test current, $T_c=85^\circ\text{C}$.

BIN	LUMINOUS FLUX ⁽¹⁾ (lm)	
	MINIMUM	MAXIMUM
T	220	240
V	240	260
W	260	280

Notes for Table 6:

1. Lumileds maintains a tolerance of $\pm 6.5\%$ on luminous flux measurements.

Color Codes

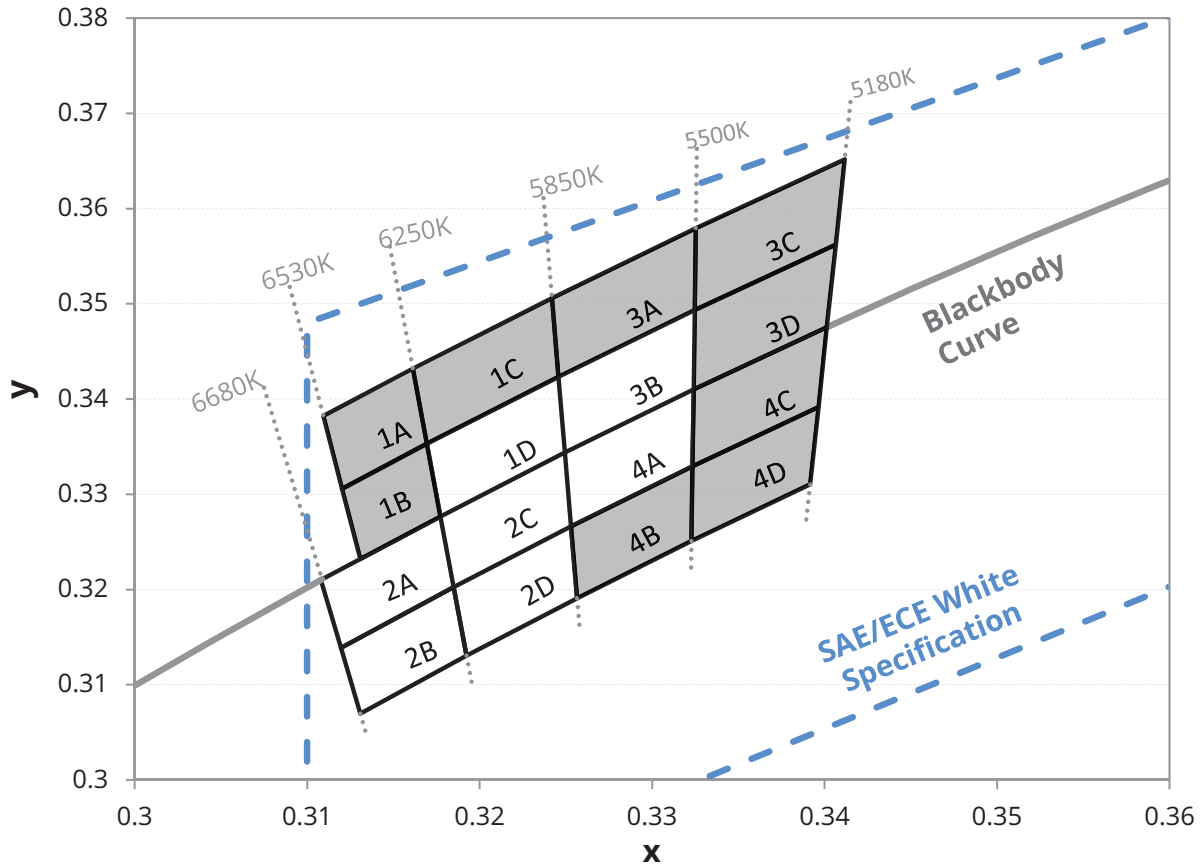

Figure 9. Color bin structure in CIE 1931 color space for LUXEON F ES Cool White.

Notes for Figure 9:

1. Lumileds supports the following bins for LUXEON F ES Cool White: H2 and HC.
2. LUXEON F historical large color notations. Color bins must be ordered by fine bin designators, shown below.
 H1 = 1A, 1B, 1C, 1D
 H2 = 2A, 2B, 2C, 2D
 H3 = 3A, 3B, 3C, 3D
 H4 = 4A, 4B, 4C, 4D
 HC = 1D, 2C, 3B, 4A

Color Bin Definitions

Table 7. Color bin definitions for LUXEON F ES Cool White.

BIN	x	y	6-DIGIT IEC CODE	TYPICAL CCT	BIN	x	y	6-DIGIT IEC CODE	TYPICAL CCT
2B	0.3120	0.3139	ebvG33	6460K	1B	0.3120	0.3306	fbwA23	6390K
	0.3185	0.3203				0.3169	0.3353		
	0.3192	0.3131				0.3177	0.3277		
	0.3131	0.3070				0.3131	0.3232		
2D	0.3185	0.3203	ebyG33	6050K	1D	0.3169	0.3353	fbyA33	6050K
	0.3253	0.3266				0.3246	0.3424		
	0.3256	0.3191				0.3249	0.3344		
	0.3192	0.3131				0.3177	0.3277		
4B	0.3253	0.3266	ecbG33	5680K	3B	0.3246	0.3424	fcbA33	5680K
	0.3323	0.3329				0.3325	0.3493		
	0.3323	0.3251				0.3324	0.3410		
	0.3256	0.3191				0.3249	0.3344		
4D	0.3323	0.3329	eceG33	5350K	3D	0.3325	0.3493	fceA33	5350K
	0.3396	0.3392				0.3406	0.3562		
	0.3392	0.3310				0.3401	0.3476		
	0.3323	0.3251				0.3324	0.3410		
2A	0.3109	0.3211	ebvD33	6460K	1A	0.3109	0.3382	fbwD23	6390K
	0.3177	0.3277				0.3161	0.3432		
	0.3185	0.3203				0.3169	0.3353		
	0.3120	0.3139				0.3120	0.3306		
2C	0.3177	0.3277	ebyD33	6050K	1C	0.3161	0.3432	fbyD33	6050K
	0.3249	0.3344				0.3242	0.3506		
	0.3253	0.3266				0.3246	0.3424		
	0.3185	0.3203				0.3169	0.3353		
4A	0.3249	0.3344	ecbD33	5680K	3A	0.3242	0.3506	fcbD33	5680K
	0.3324	0.3410				0.3325	0.3579		
	0.3323	0.3329				0.3325	0.3493		
	0.3253	0.3266				0.3246	0.3424		
4C	0.3324	0.3410	eceD33	5350K	3C	0.3325	0.3579	fceD33	5350K
	0.3401	0.3476				0.3412	0.3652		
	0.3396	0.3392				0.3406	0.3562		
	0.3323	0.3329				0.3325	0.3493		

Notes for Table 7:

1. Lumileds maintains a tester tolerance of ± 0.005 on x and y color coordinates.
2. CIE 1931 x and y coordinate frame.

Forward Voltage Bins

Table 8. Forward voltage bin definitions for LUXEON F ES Cool White.

BIN	FORWARD VOLTAGE ⁽¹⁾ (V _f)	
	MINIMUM	MAXIMUM
B	2.55	2.79
C	2.79	3.03
D	3.03	3.27

Notes for Table 8:

1. Lumileds maintains a tolerance of $\pm 0.06V$ on forward voltage measurements.
2. Although several bins are outlined, product availability in a particular bin varies by production run and product performance.

Mechanical Dimensions

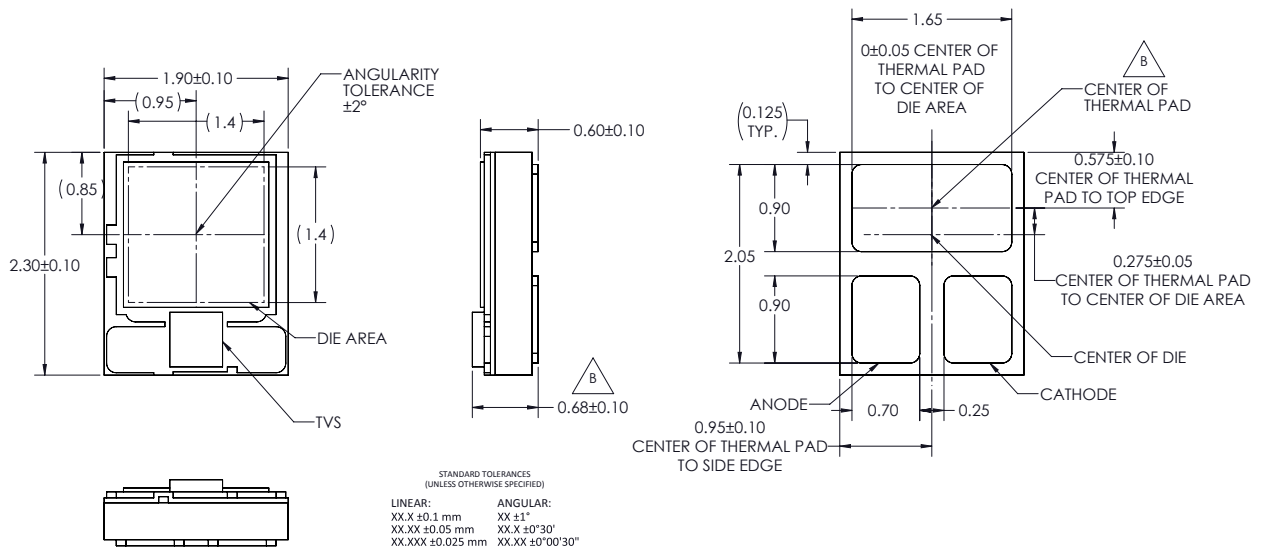

Figure 10. Mechanical dimensions for LUXEON F ES Cool White.

Notes for Figure 10:

1. Drawings are not to scale.
2. All dimensions are in millimeters.

Packaging Information

Pocket Tape Dimensions

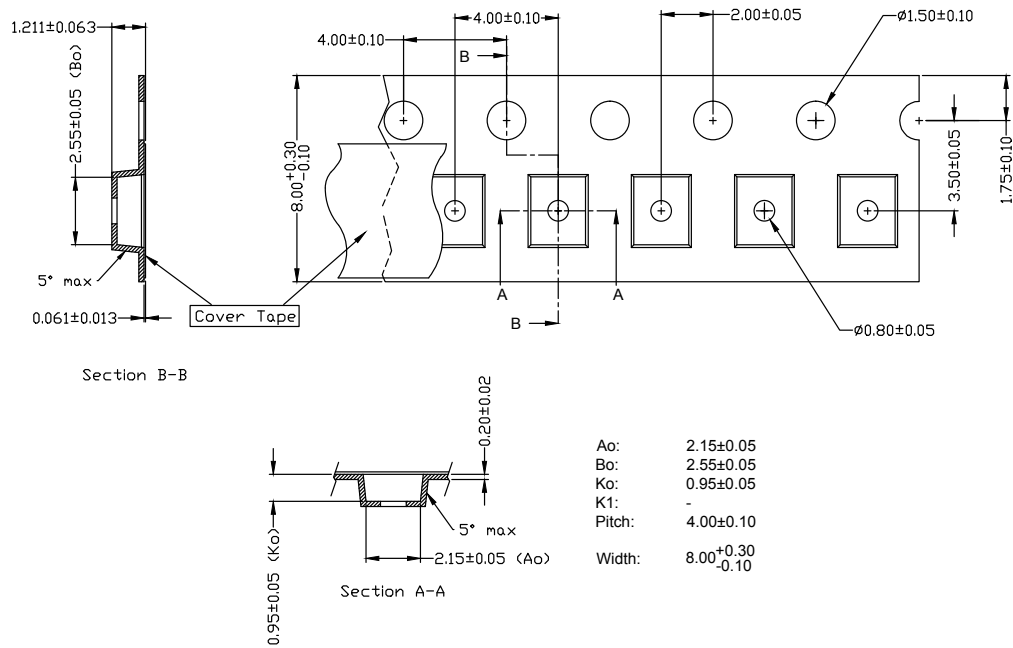

Figure 11. Pocket Tape dimensions for LUXEON F ES Cool White.

Notes for Figure 11:

1. Drawings are not to scale.
2. All dimensions are in millimeters.
3. Ao is the width of pocket and Ko is the depth of pocket. Bo is the height of pocket.

Reel Dimensions

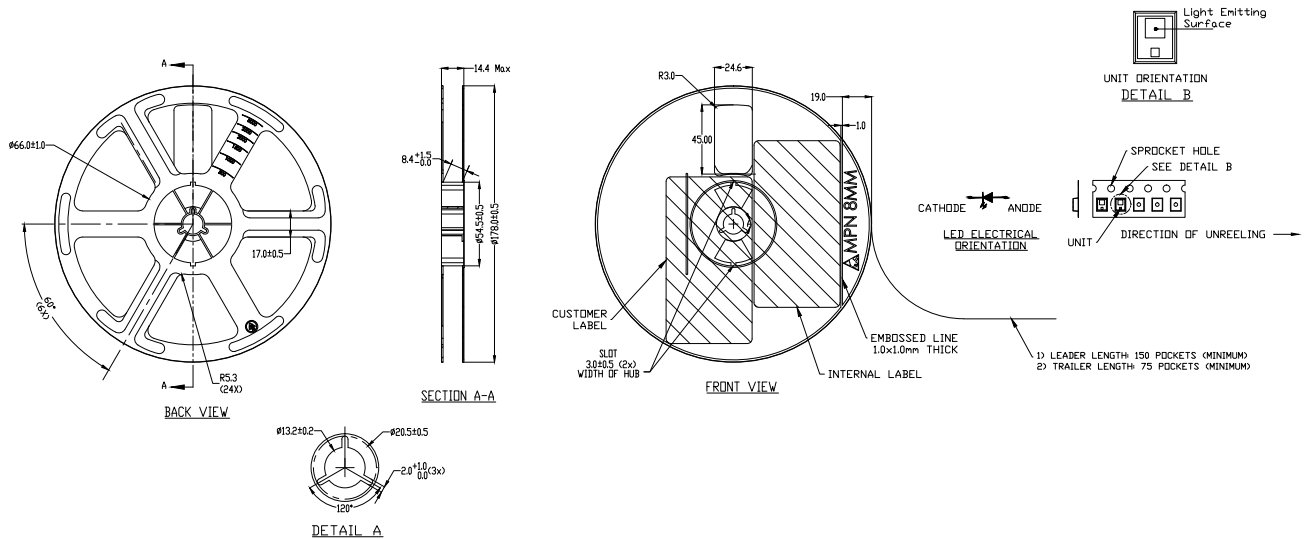

Figure 12. Reel dimensions for LUXEON F ES Cool White.

Notes for Figure 12:

1. Drawings are not to scale.
2. All dimensions are in millimeters.

About Lumileds

Companies developing automotive, mobile, IoT and illumination lighting applications need a partner who can collaborate with them to push the boundaries of light. With over 100 years of inventions and industry firsts, Lumileds is a global lighting solutions company that helps customers around the world deliver differentiated solutions to gain and maintain a competitive edge. As the inventor of Xenon technology, a pioneer in halogen lighting and the leader in high performance LEDs, Lumileds builds innovation, quality and reliability into its technology, products and every customer engagement. Together with its customers, Lumileds is making the world safer, better and more beautiful—with light.

To learn more about our lighting solutions, visit lumileds.com.



©2017 Lumileds Holding B.V. All rights reserved.
LUXEON is a registered trademark of the Lumileds Holding B.V. in the United States and other countries.

lumileds.com

Neither Lumileds Holding B.V. nor its affiliates shall be liable for any kind of loss of data or any other damages, direct, indirect or consequential, resulting from the use of the provided information and data. Although Lumileds Holding B.V. and/or its affiliates have attempted to provide the most accurate information and data, the materials and services information and data are provided "as is," and neither Lumileds Holding B.V. nor its affiliates warrants or guarantees the contents and correctness of the provided information and data. Lumileds Holding B.V. and its affiliates reserve the right to make changes without notice. You as user agree to this disclaimer and user agreement with the download or use of the provided materials, information and data. A listing of Lumileds product/patent coverage may be accessed at lumileds.com/patents.